



Nahtinstrumente
Suture Instruments
Instrumentos para sutura
Strumenti per sutura

**Nadelhalter
Needle Holders
Porta-agujas
Portaghi**



75-1715-12
12,0 cm, 4³/₄"



75-1716-12
12,5 cm, 5"



COLLIER
12,5 cm, 5"
75-1717-12



WEBSTER
13,0 cm, 5"
75-1718-13



HALSEY
13,0 cm, 5"

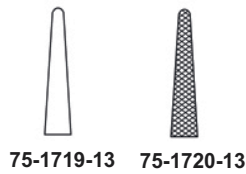

75-1719-13



75-1720-13



NEIVERT
13,0 cm, 5"
75-1721-13

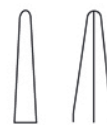

HEGAR-BAUMGARTNER
14,0 cm, 5¹/₂"
75-1722-14



Nadelhalter
Needle Holders
Porta-agujas
Portaghi



BROWN



CRILE-MURRAY
15,0 cm, 6"
75-1725-15



CRILE-WOOD



ADSON
18,0 cm, 7"
75-1726-18



METZENBAUM
18,0 cm, 7"
75-1727-18



MASS.-GENERAL-HOSPITAL
17,0 cm, 6 3/4"
75-1728-17

Nadelhalter
Needle Holders
Porta-agujas
Portaghi

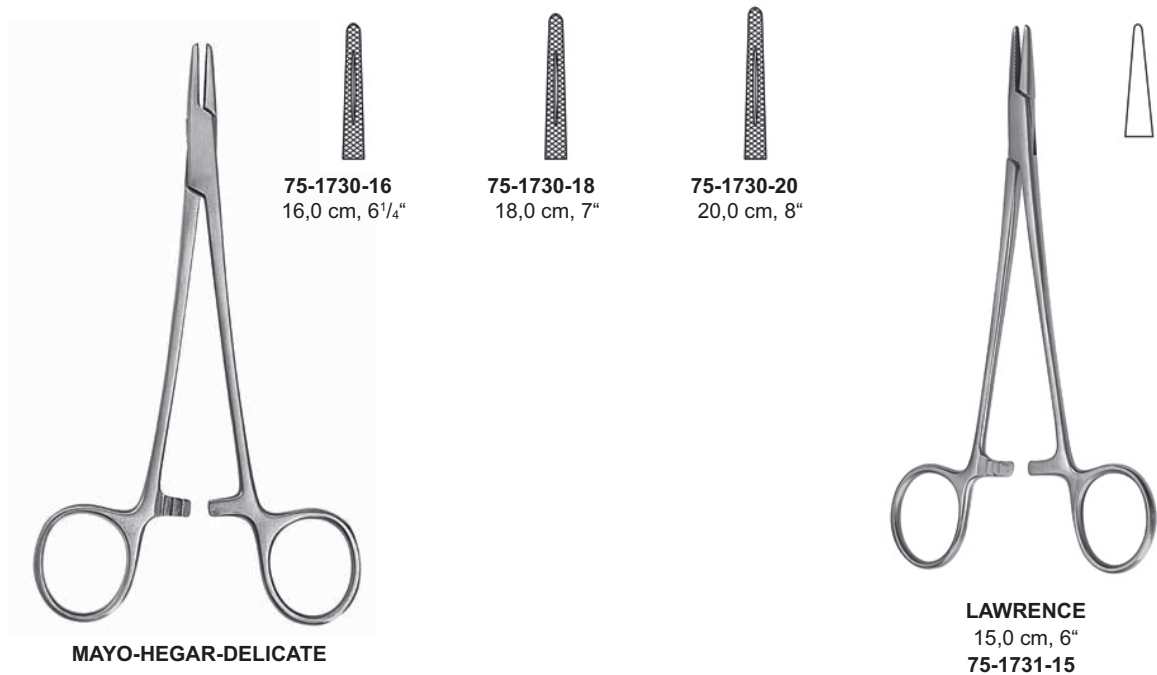
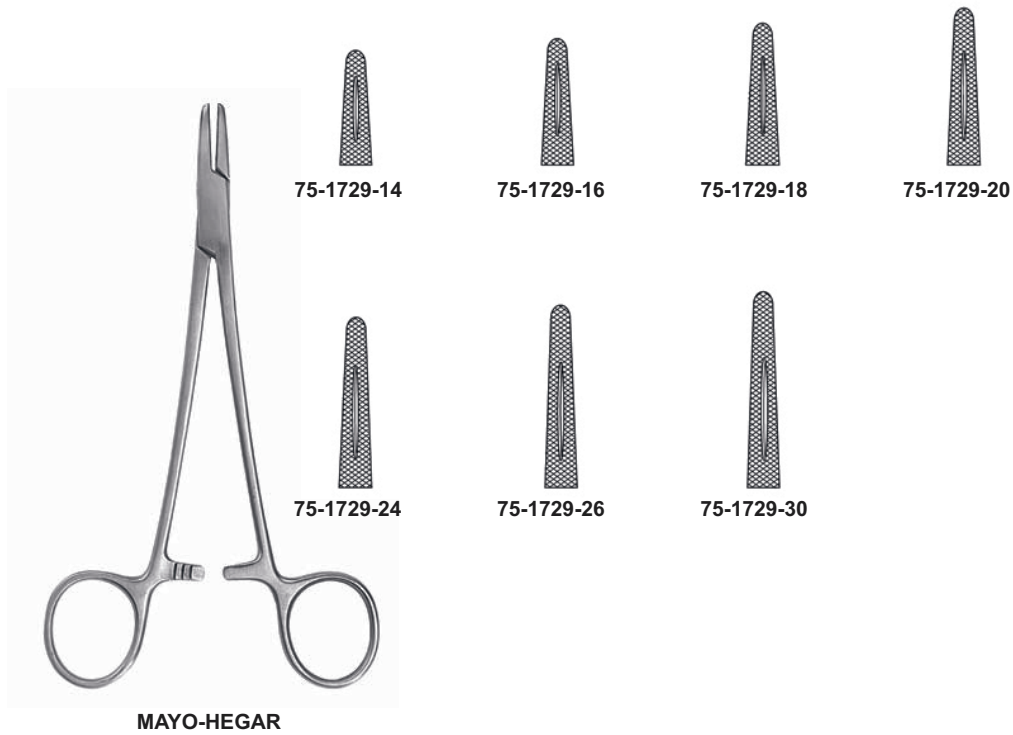

Nadelhalter
Needle Holders
Porta-agujas
Portaghi



HEANEY

21,0 cm, 8¹/₄"
75-1732-21



JAMISON

23,5 cm, 9¹/₄"
75-1733-23



MASSON

27,0 cm, 10¹/₂"
75-1734-27



FINOCCHIETTO
27,0 cm, 10¹/₂"
75-1735-27



WANGENSTEEN
27,0 cm, 10¹/₂"
75-1736-27



JOHNSON
27,0 cm, 10¹/₂"
75-1737-27

**Nadelhalter
Needle Holders
Porta-agujas
Portaghi**

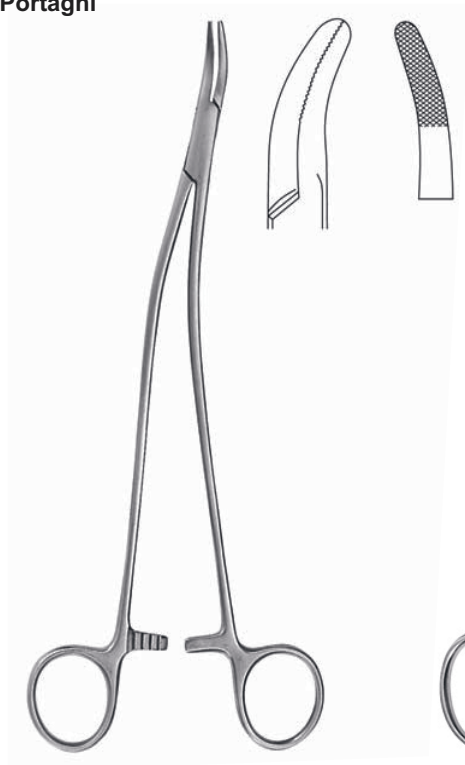

STRATTE
23,0 cm, 9"
75-1738-23



OLSEN-HEGAR
17,0 cm, 6³/₄"
75-1739-17

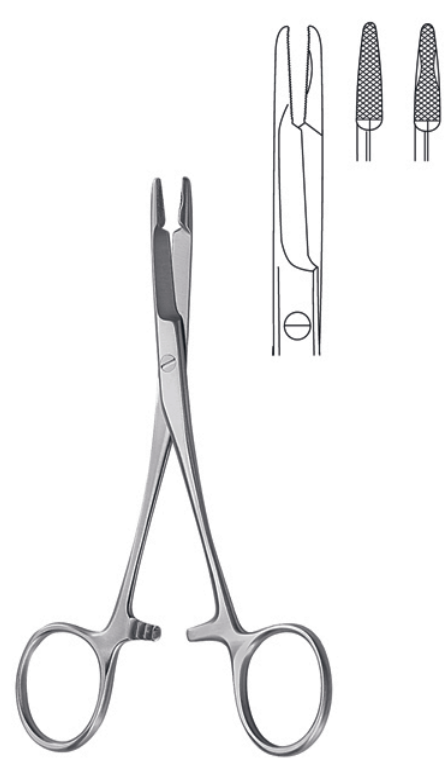

OLSEN-HEGAR
14,0 cm, 5¹/₂"
75-1740-14



OLSEN-HEGAR

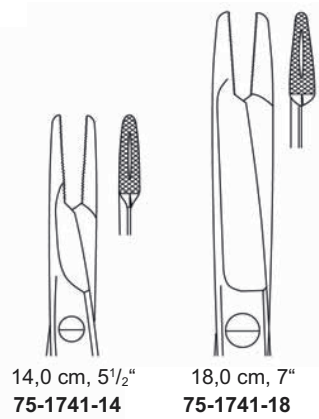

14,0 cm, 5¹/₂"
75-1741-14



18,0 cm, 7"
75-1741-18



TOENNIS
18,0 cm, 7"
75-1742-18

Nadelhalter, Mikro-Nadelhalter
Needle Holders, Micro Needle Holders
Porta-agujas, Micro Porta-agujas
Portaghi, Micro Portaghi



MATHIEU-KOCHER



75-1747-14
14,0 cm, 5½"



75-1747-17
17,0 cm, 6¾"



75-1747-20
20,0 cm, 8"



BARRAQUER-TROUTMAN
10,0 cm, 4"



75-1748-10



75-1749-10



BARRAQUER



75-1750-10



75-1751-10



BARRAQUER
13,5 cm, 5⅜"
75-1752-13



GOMEL
14,0 cm, 5½"
75-1753-14



**Nadelhalter
Needle Holders
Porta-agujas
Portaghi**



75-1743-14
14,0 cm, 5½"

75-1743-17
17,0 cm, 6¾"

75-1743-20
20,0 cm, 8"

MATHIEU



75-1744-17
17,0 cm, 6¾"

75-1744-20
20,0 cm, 8"

MATHIEU



LICHTENBERG
20,0 cm, 8"
75-1746-20



MATHIEU

75-1745-14
14,0 cm, 5½"

75-1745-17
17,0 cm, 6¾"

Mikro-Nadelhalter
Micro Needle Holders
Micro Porta-agujas
Micro Portaghi

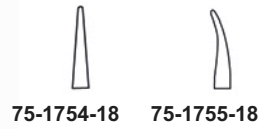

ohne Sperre
without ratchet
sin cremallera
senza cremagliera

18,5 cm, 7¹/₄"

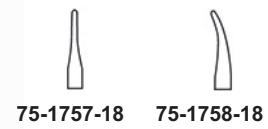

mit Sperre
with ratchet
con cremallera
con cremagliera

18,5 cm, 7¹/₄"

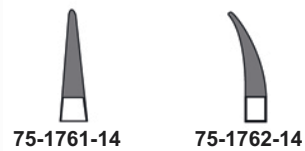
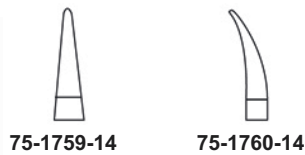

mit Sperre
with ratchet
con cremallera
con cremagliera

CASTROVIEJO
14,5 cm, 5³/₄"

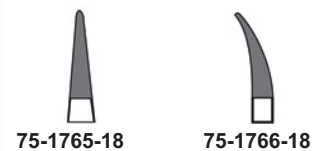
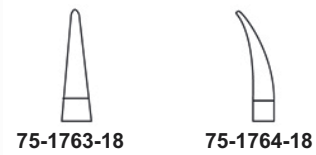

mit Sperre
with ratchet
con cremallera
con cremagliera

CASTROVIEJO
18,0 cm, 7"

Mikro-Nadelhalter
Micro Needle Holders
Micro Porta-agujas
Micro Portaghi

0,4 mm



gerade, ohne Sperre
straight, without ratchet
recta, sin cremallera
retta, senza cremagliera

14,0 cm, 5 1/2"
75-1767-14

0,4 mm



gebogen, ohne Sperre
curved, without ratchet
curva, sin cremallera
curva, senza cremagliera

14,0 cm, 5 1/2"
75-1768-14

0,4 mm



14,0 cm, 5 1/2"
75-1769-14

0,5 mm



gebogen, ohne Sperre
curved, without ratchet
curva, sin cremallera
curva, senza cremagliera

Ø 10 mm

14,0 cm, 5 1/2"
75-1770-14

0,5 mm



gebogen, ohne Sperre
curved, without ratchet
curva, sin cremallera
curva, senza cremagliera

Ø 10 mm

14,0 cm, 5 1/2"
75-1771-14

0,4 mm



gebogen, ohne Sperre
curved, without ratchet
curva, sin cremallera
curva, senza cremagliera

Ø 8 mm

13,0 cm, 5"
75-1772-13

0,4 mm



gebogen, ohne Sperre
curved, without ratchet
curva, sin cremallera
curva, senza cremagliera

Ø 8 mm

13,0 cm, 5"
75-1773-13

Nadelhalter mit Hartmetalleinlagen
Needle Holders with tungsten carbide inserts
Porta-agujas con bocas de carburo tungsteno
Portaghi con morsi in carburo di tungsteno



KALT
13,5 cm, 5³/₈"
75-1776-14

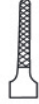

16,0 cm, 5 ³ / ₈ "	75-1775-16
18,0 cm, 7"	75-1775-18
20,0 cm, 8"	75-1775-20
23,0 cm, 9"	75-1775-23
26,0 cm, 10 ¹ / ₄ "	75-1775-26

DIETHRICH



WEBSTER
13,0 cm, 5"
75-1777-13



DERF
12,0 cm, 4³/₄"
75-1780-12



75-1778-12
12,5 cm, 5"



75-1779-14
14,0 cm, 5¹/₂"

HEGAR-BAUMGARTNER



WEBSTER
13,0 cm, 5"
75-1781-13

Nadelhalter mit Hartmetalleinlagen
 Needle Holders with tungsten carbide inserts
 Porta-agujas con bocas de carburo tungsteno
 Portaghi con morsi in carburo di tungsteno



HALSEY
13,0 cm, 5"

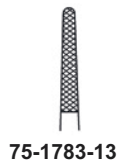

CRILE-WOOD

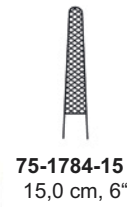

SAROT

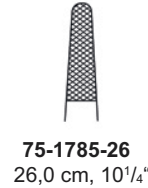
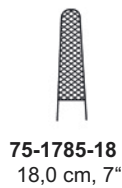

Nadelhalter mit Hartmetalleinlagen
Needle Holders with tungsten carbide inserts
Porta-agujas con bocas de carburo tungsteno
Portaghi con morsi in carburo di tungsteno



75-1786-16
16,0 cm, 6¹/₄"

75-1786-18
18,0 cm, 7"

75-1786-20
20,0 cm, 8"

75-1786-24
24,0 cm, 9¹/₂"

75-1786-26
26,0 cm, 10¹/₄"

75-1786-30
30,0 cm, 12"

MAYO-HEGAR



75-1787-20
20,0 cm, 8"

75-1787-24
24,0 cm, 9¹/₄"

75-1787-26
26,0 cm, 10¹/₄"

MAYO-HEGAR (HEANEY)

Surgical Catalogue

Nadelhalter mit Hartmetalleinlagen
Needle Holders with tungsten carbide inserts
Porta-agujas con bocas de carburo tungsteno
Portaghi con morsi in carburo di tungsteno

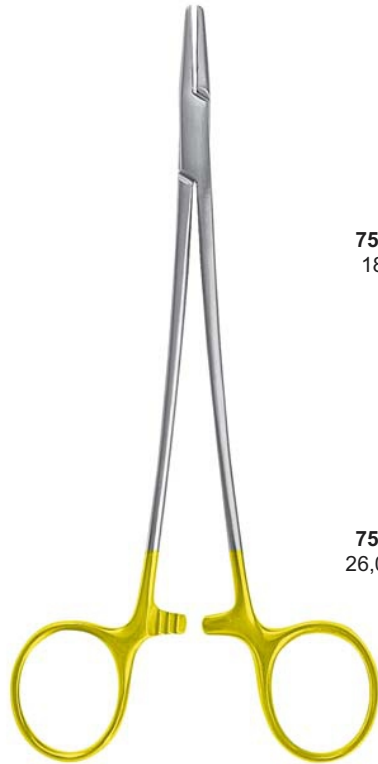

DE BAKEY



75-1788-18
18,0 cm, 7"



75-1788-20
20,0 cm, 8"



75-1788-23
23,0 cm, 9"



75-1788-26
26,0 cm, 10¹/₄"



75-1788-31
31,0 cm, 12¹/₄"



75-1788-37
37,0 cm, 14¹/₂"

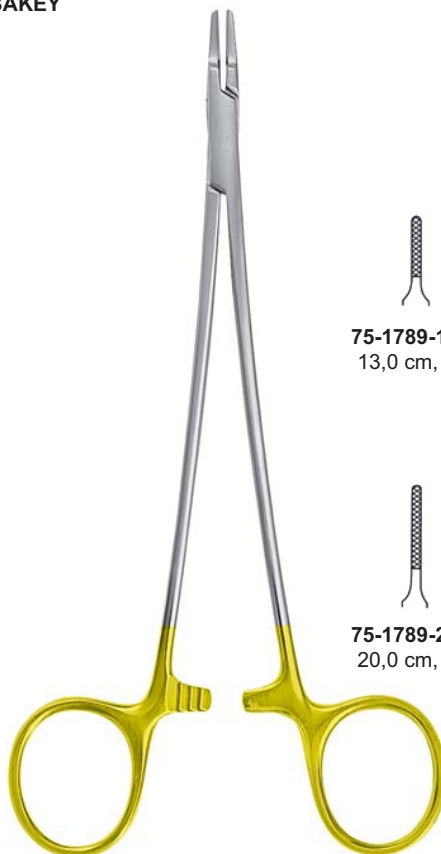

RYDER-VASCULAR



75-1789-13
13,0 cm, 5"



75-1789-15
15,0 cm, 6"

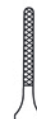

75-1789-18
18,0 cm, 7"

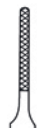

75-1789-20
20,0 cm, 8"

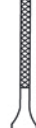

75-1789-23
23,0 cm, 9"



75-1789-26
26,0 cm, 10¹/₄"

Nadelhalter mit Hartmetalleinlagen
Needle Holders with tungsten carbide inserts
Porta-agujas con bocas de carburo tungsteno
Portaghi con morsi in carburo di tungsteno



RYDER

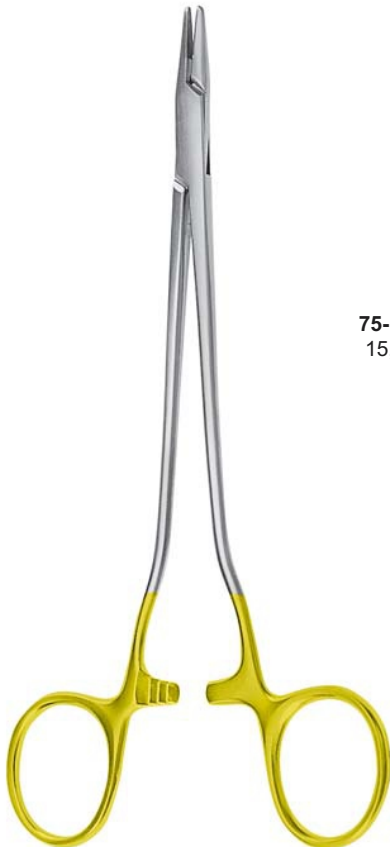
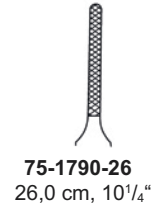
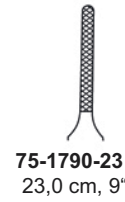
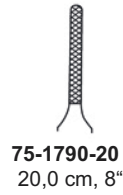
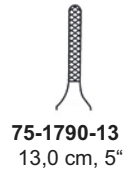

SCHWEDISCHES MODELL

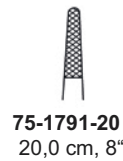
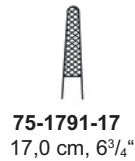
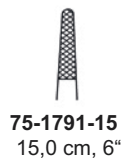

Nadelhalter mit Hartmetalleinlagen
Needle Holders with tungsten carbide inserts
Porta-agujas con bocas de carburo tungsteno
Portaghi con morsi in carburo di tungsteno

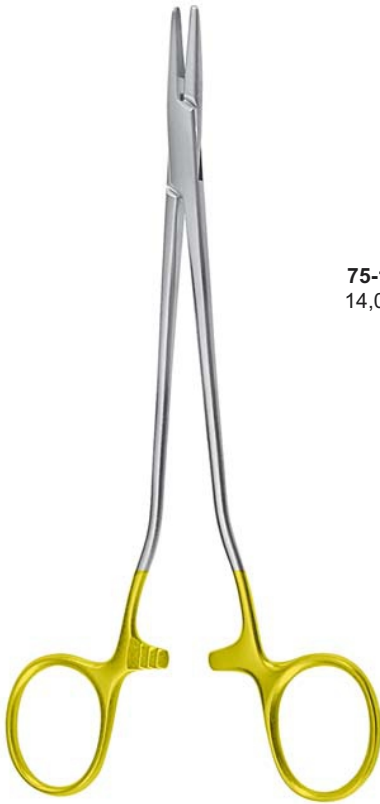

MAYO-HEGAR (HEANEY)



75-1792-14
14,0 cm, 5½"



75-1792-18
18,0 cm, 7"



75-1792-20
20,0 cm, 8"



75-1792-23
23,0 cm, 9"



FINOCCHIETTO
27,0 cm, 10½"
75-1793-27



MASSON
27,0 cm, 10½"
75-1794-27



WANGENSTEIN
27,0 cm, 10½"
75-1795-27

Nadelhalter mit Hartmetalleinlagen
Needle Holders with tungsten carbide inserts
Porta-agujas con bocas de carburo tungsteno
Portaghi con morsi in carburo di tungsteno



BOZEMANN

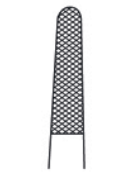

75-1796-20
20,0 cm, 8"



75-1796-24
24,0 cm, 9⁵/₈"



75-1796-26
26,0 cm, 10¹/₄"



HEGAR



75-1797-20
20,0 cm, 8"



75-1797-24
24,0 cm, 9⁵/₈"

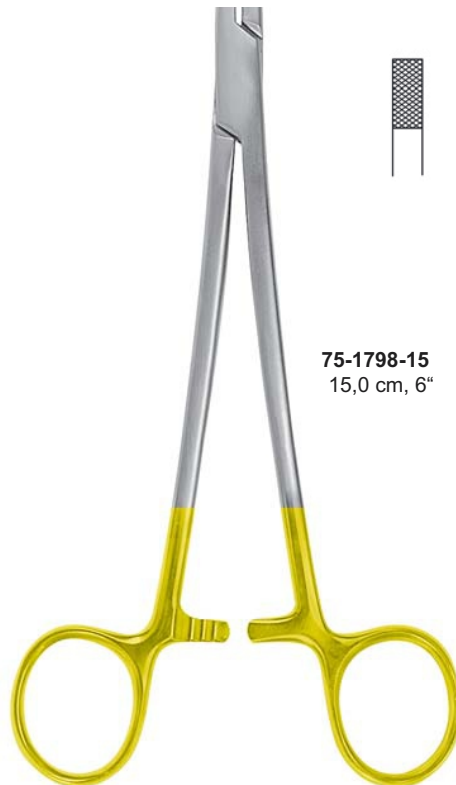

BARRY STERNAL



75-1798-15
15,0 cm, 6"



75-1798-20
20,0 cm, 8"

Nadelhalter mit Hartmetalleinlagen
Needle Holders with tungsten carbide inserts
Porta-agujas con bocas de carburo tungsteno
Portaghi con morsi in carburo di tungsteno



STRATTE

75-1799-22
22,0 cm, 8⁵/₈"

75-1799-23
23,0 cm, 9"



GILLIES
16,0 cm, 6¹/₄"
75-1800-16



OLSEN-HEGAR

75-1801-14
14,0 cm, 5¹/₂"

75-1801-17
17,0 cm, 6³/₄"

75-1801-18
18,0 cm, 7"



TOENNIS
18,0 cm, 7"
75-1802-18

Nadelhalter mit Hartmetalleinlagen
 Needle Holders with tungsten carbide inserts
 Porta-agujas con bocas de carburo tungsteno
 Portaghi con morsi in carburo di tungsteno



MATHIEU-KOCHER



75-1803-14
14,0 cm, 5½"



75-1803-17
17,0 cm, 6¾"



75-1803-20
20,0 cm, 8"



MATHIEU



75-1804-14
14,0 cm, 5½"



75-1804-17
17,0 cm, 6¾"



75-1804-20
20,0 cm, 8"

Nadelhalter mit Hartmetalleinlagen
Needle Holders with tungsten carbide inserts
Porta-agujas con bocas de carburo tungsteno
Portaghi con morsi in carburo di tungsteno



LICHTENBERG



75-1805-17
17,0 cm, 6³/₄"



75-1805-20
20,0 cm, 8"



MATHIEU



75-1806-17
17,0 cm, 6³/₄"



75-1806-20
20,0 cm, 8"



75-1806-23
23,0 cm, 9"

Nadelhalter mit Hartmetalleinlagen
Needle Holders with tungsten carbide inserts
Porta-agujas con bocas de carburo tungsteno
Portaghi con morsi in carburo di tungsteno



ZWEIFEL



75-1807-20
20,0 cm, 8"



75-1807-23
23,0 cm, 9"



LANGENBECK



75-1808-18
18,0 cm, 7"



75-1808-20
20,0 cm, 8"



75-1808-23
23,0 cm, 9"



75-1809-18
18,0 cm, 7"



75-1809-20
20,0 cm, 8"



75-1809-23
23,0 cm, 9"

Nadelhalter mit Hartmetalleinlagen
 Needle Holders with tungsten carbide inserts
 Porta-agujas con bocas de carburo tungsteno
 Portaghi con morsi in carburo di tungsteno



75-1810-14



75-1810-14



75-1810-14



75-1810-14

mit Sperre
 with ratchet
 con cremallera
 con cremagliera

CASTROVIEJO
 14,5 cm, 5³/₄"



75-1811-18



75-1812-18



75-1813-18



75-1874-18

mit Sperre
 with ratchet
 con cremallera
 con cremagliera

CASTROVIEJO
 18,0 cm, 7"



75-1815-14



75-1816-14



75-1817-14



75-1818-14

mit Sperre
 with ratchet
 con cremallera
 con cremagliera

BARRAQUER
 14,5 cm, 5³/₄"



HEPP SCHEIDEL
 18,0 cm, 7"
 75-1819-18

REVERDIN-Nadeln
REVERDIN Needles
Agujas de REVERDIN
Aghi di REVERDIN



REVERDIN
14,0 cm, 5 1/2"

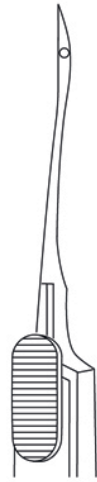

75-1820-01

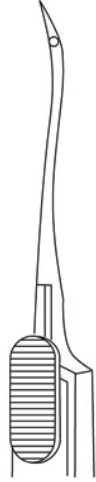

75-1820-02

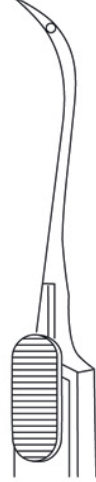

75-1820-03



75-1820-04



REVERDIN

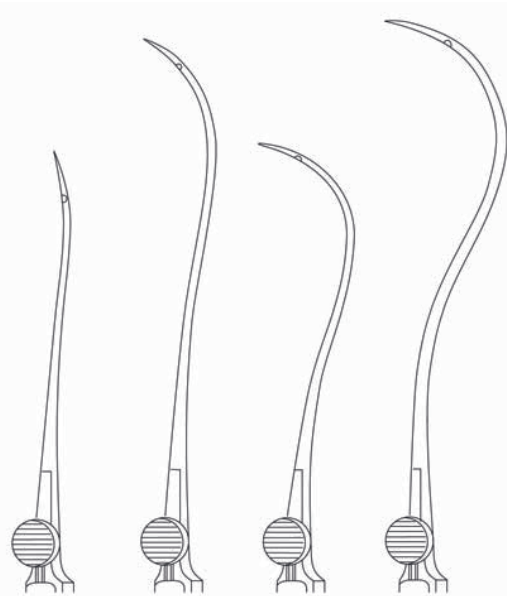

19,5 cm, 7 3/4" 75-1821-01 75-1821-02 75-1821-03 75-1821-04
22,5 cm, 8 3/4" 75-1822-01 75-1822-02 75-1822-03 75-1822-04

**Unterbindungsnadeln
Ligature Needles
Agujas para ligaduras
Aghi per legatura**

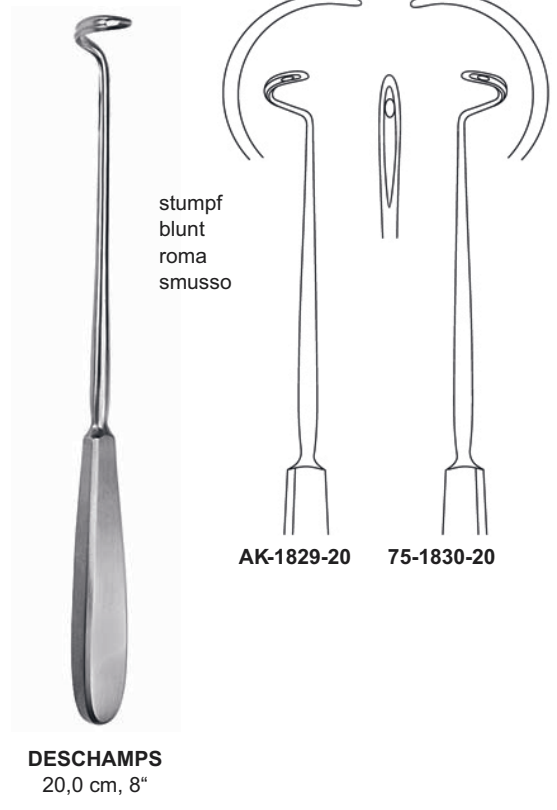
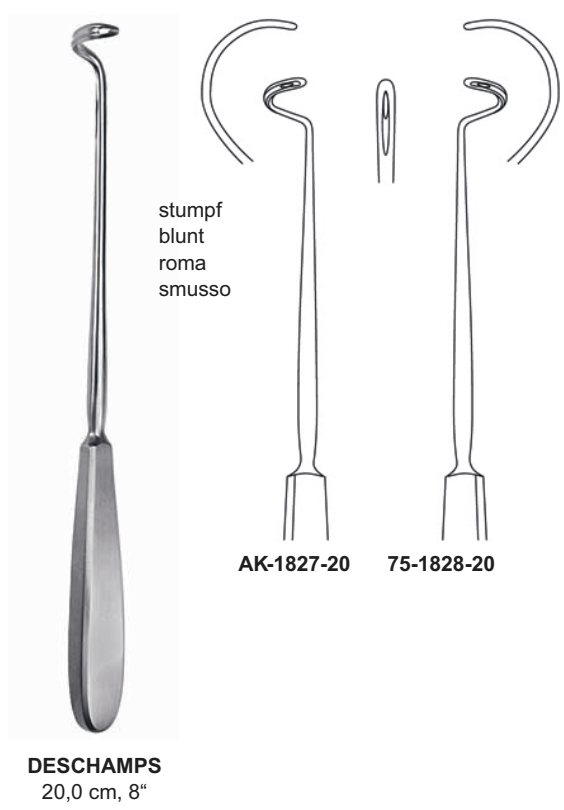
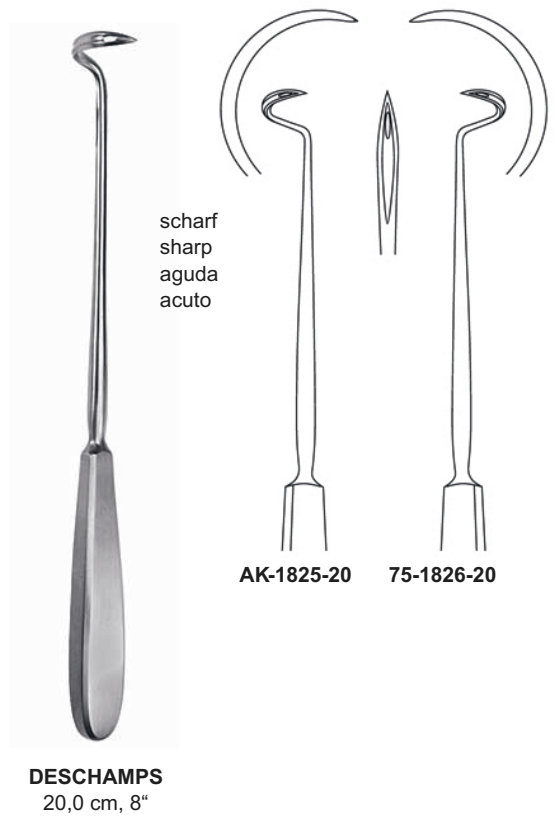
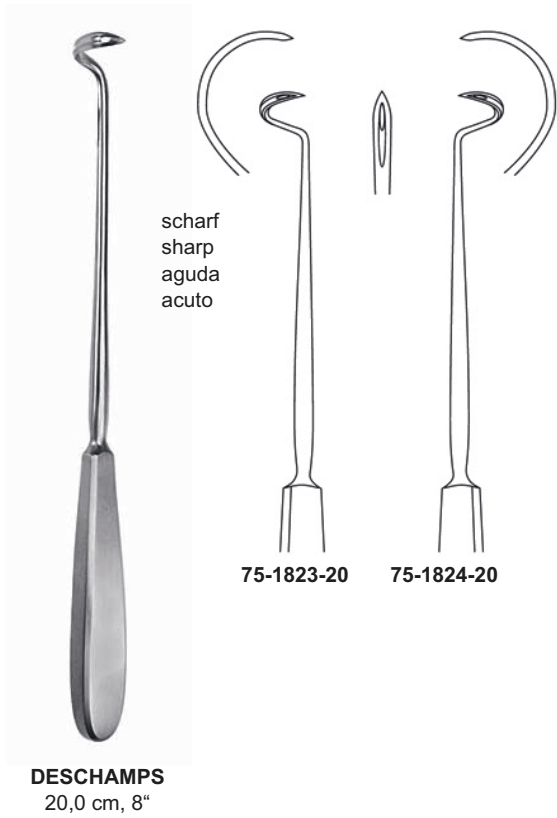

Unterbindungsnadeln
Ligature Needles
Agujas para ligaduras
Aghi per legatura

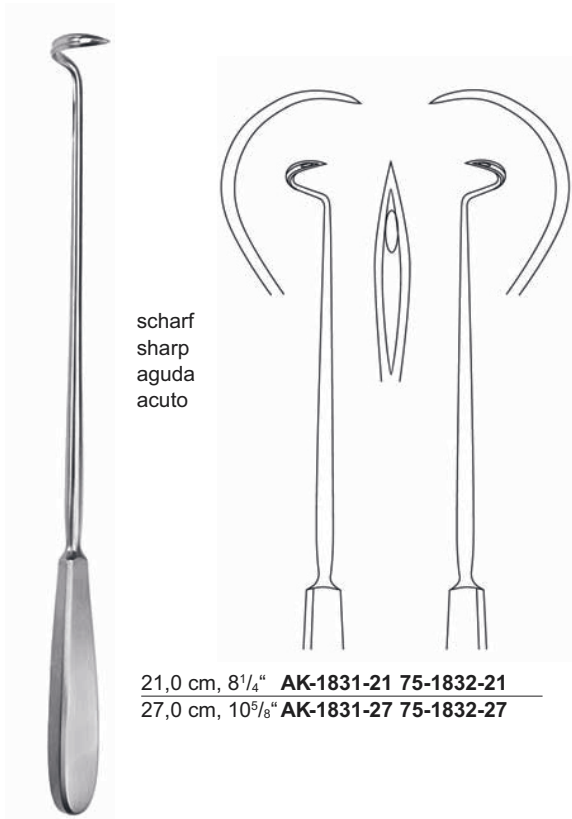

scharf
sharp
aguda
acuto

21,0 cm, 8¹/₄" **AK-1831-21 75-1832-21**
27,0 cm, 10⁵/₈" **AK-1831-27 75-1832-27**

DESCHAMPS

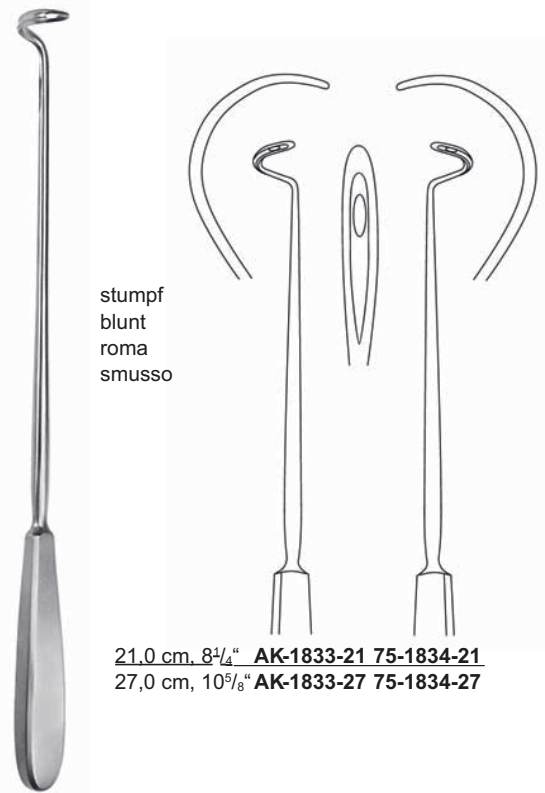

stumpf
blunt
roma
smusso

21,0 cm, 8¹/₄" **AK-1833-21 75-1834-21**
27,0 cm, 10⁵/₈" **AK-1833-27 75-1834-27**

DESCHAMPS



biegsam
malleable
maleable
malleabile

20,0 cm, 8"
75-1835-20



COOPER
19,0 cm, 7¹/₂"
75-1836-19



COOPER
20,0 cm, 8"
75-1837-20



SYME
15,0 cm, 6"
75-1838-15

Unterbindungsnadeln
Ligature Needles
Agujas para ligaduras
Aghi per legatura



KOCHER
19,0 cm, 7¹/₂"



75-1839-01



75-1839-02



75-1839-03



BRUNNER
25,0 cm, 9³/₄"
75-1840-25



BRUNNER
30,0 cm, 11³/₄"



75-1841-01



75-1841-02



SCHMIEDEN
21,0 cm, 8¹/₄"
75-1842-21

Unterbindungsnadeln
Ligature Needles
Agujas para ligaduras
Aghi per legatura



KRONECKER
15,0 cm, 6"
75-1850-02



TRÉLAT
23,0 cm, 9"
75-1851-23



CLAUS
23,0 cm, 9"
75-1852-23



HURD
21,0 cm, 8 1/4"
75-1853-01



HURD
21,0 cm, 8 1/4"
75-1854-02



NAGER
24,0 cm, 9 1/2"
75-1855-24



CLAUS-EICKEN
23,0 cm, 9"
75-1856-23



FALK
24,0 cm, 9 1/2"
75-1857-01

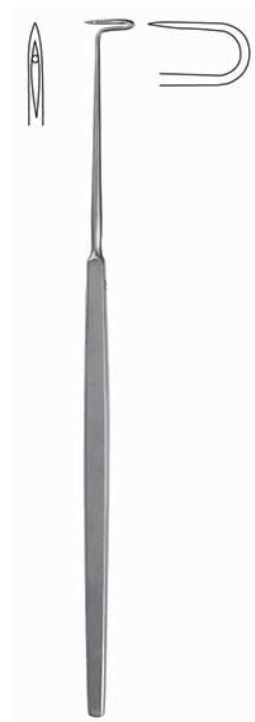

FALK
24,0 cm, 9 1/2"
75-1858-02

Unterbindungsnadeln
Ligature Needles
Agujas para ligaduras
Aghi per legatura



YOUNG-HRYNTSCHAK
24,0 cm, 9½"
75-1844-24



75-1843-01



75-1843-02



75-1843-03



DE LA ROZA
12,0 cm, 4¾"
75-1845-01



DE LA ROZA
12,0 cm, 4¾"
75-1846-02



JAKOBI
14,0 cm, 5½"
75-1847-14



HESSEBERG
15,0 cm, 6"
75-1848-15



KRONECKER
15,0 cm, 6"
75-1849-01

Führungshohlsonden
Ligature Conductors
Sondas conductoras
Sonde conduttrici



PAYR
22,0 cm, 8⁵/₈"
75-1860-22



PAYR
22,0 cm, 8⁵/₈"
75-1861-22



mit Loch
with hole
con foro
con ago

SCHMIEDEN-PAYR
19,0 cm, 7¹/₂"
75-1862-19



ohne Loch
without hole
sin foro
senza ago

SCHMIEDEN
19,0 cm, 7¹/₂"
75-1863-19



KÖNIG
19,5 cm, 7³/₄"
75-1864-03



KÖNIG
19,5 cm, 7³/₄"
75-1865-05



KÖNIG
19,5 cm, 7³/₄"
75-1866-07

Führungshohlsonden
Ligature Conductors
Sondas conductoras
Sonde conduttrici

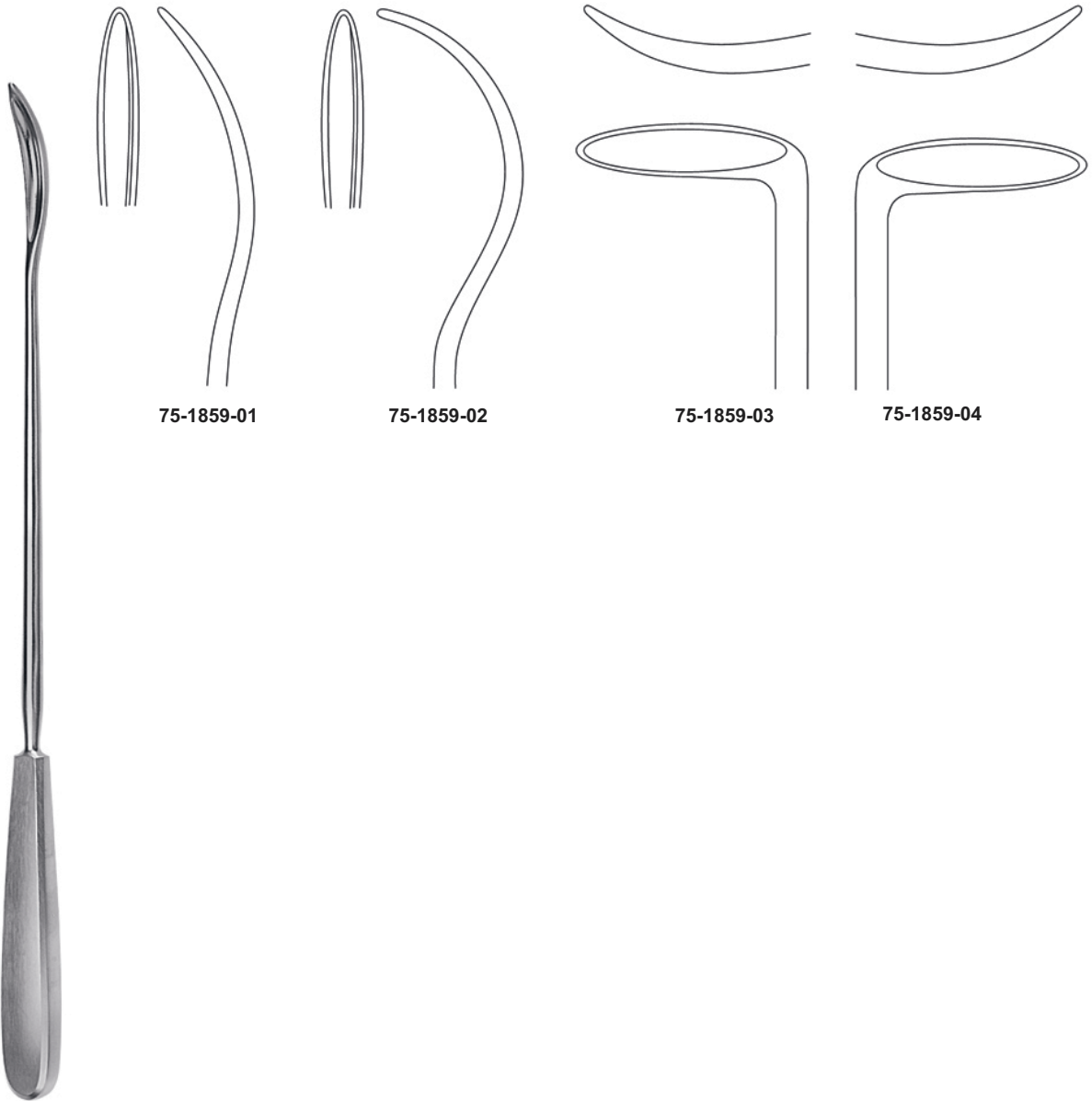

BRUNNER
30,0 cm, 11³/₄"

Nahtinstrumente
Suture Instruments
Instrumentos para sutura
Strumenti per sutura



MOD. WIEN
23,5 cm, 9¹/₄"
75-1872-23



BOZEMANN
21,0 cm, 8¹/₄"
75-1873-21



23,0 cm, 9"
75-1874-23



MICHEL
12,0 cm, 4³/₄"
027-1875-12



COLLIN
13,0 cm, 5"
75-1876-13



RICHTER-HEATH
14,0 cm, 5¹/₂"
75-1877-14



WACHENFELDT
12,5 cm, 5"
75-1878-01



HEGENBARTH
12,5 cm, 5"
75-1879-12

Führungshohlsonden
Ligature Conductors
Sondas conductoras
Sonde conduttrici



KIRSCHNER

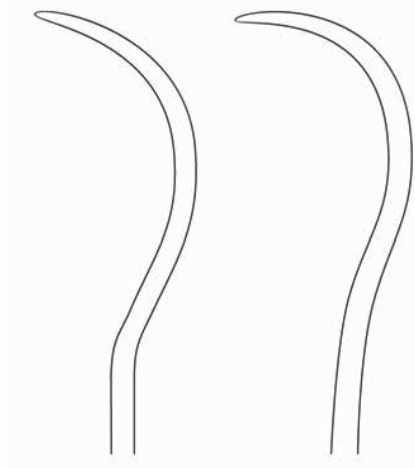

25,5 cm, 10"
75-1867-25

28,0 cm, 11"
75-1867-28



BRUNNER-FERROZELL

18,0 cm, 7" 75-1868-18
27,0 cm, 10⁵/₈" 75-1868-27



KOCHER



15,0 cm, 6" **AK-1869-15 75-1870-15**
16,0 cm, 6¹/₄" **AK-1869-16 75-1870-16**



18,0 cm, 7"
75-1871-18