



Scheren
Scissors
Tijeras
Forbici

Chirurgische Scheren
Surgical Scissors
Tijeras para cirugía
Forbici per chirurgia



STANDARD	
10,5 cm, 4 ¹ / ₄ "	75-1014-10
11,5 cm, 4 ¹ / ₂ "	75-1014-11
13,0 cm, 5"	75-1014-13
14,5 cm, 5 ³ / ₄ "	75-1014-14
15,5 cm, 6"	75-1014-15
16,5 cm, 6 ¹ / ₂ "	75-1014-16
17,5 cm, 6 ⁵ / ₈ "	75-1014-17
18,5 cm, 7 ¹ / ₄ "	75-1014-18
20,0 cm, 8"	75-1014-20

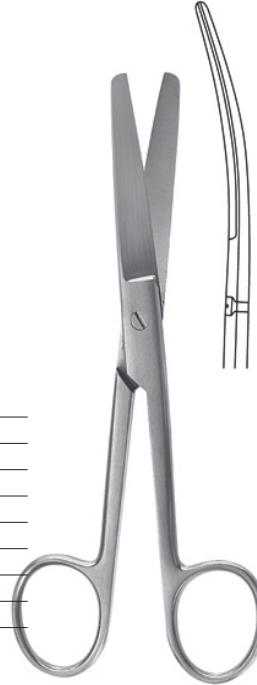

STANDARD	
10,5 cm, 4 ¹ / ₄ "	75-1015-10
11,5 cm, 4 ¹ / ₂ "	75-1015-11
13,0 cm, 5"	75-1015-13
14,5 cm, 5 ³ / ₄ "	75-1015-14
15,5 cm, 6"	75-1015-15
16,5 cm, 6 ¹ / ₂ "	75-1015-16
17,5 cm, 6 ⁵ / ₈ "	75-1015-17
18,5 cm, 7 ¹ / ₄ "	75-1015-18
20,0 cm, 8"	75-1015-20



STANDARD	
10,5 cm, 4 ¹ / ₄ "	75-1016-10
11,5 cm, 4 ¹ / ₂ "	75-1016-11
13,0 cm, 5"	75-1016-13
14,5 cm, 5 ³ / ₄ "	75-1016-14
15,5 cm, 6"	75-1016-15
16,5 cm, 6 ¹ / ₂ "	75-1016-16
17,5 cm, 6 ⁵ / ₈ "	75-1016-17
18,5 cm, 7 ¹ / ₄ "	75-1016-18
20,0 cm, 8"	75-1016-20



STANDARD	
10,5 cm, 4 ¹ / ₄ "	75-1017-10
11,5 cm, 4 ¹ / ₂ "	75-1017-11
13,0 cm, 5"	75-1017-13
14,5 cm, 5 ³ / ₄ "	75-1017-14
15,5 cm, 6"	75-1017-15
16,5 cm, 6 ¹ / ₂ "	75-1017-16
17,5 cm, 6 ⁵ / ₈ "	75-1017-17
18,5 cm, 7 ¹ / ₄ "	75-1017-18
20,0 cm, 8"	75-1017-20

Chirurgische Scheren, Präparierscheren
Surgical Scissors, Dissecting Scissors
Tijeras para cirugía, Tijeras de disección
Forbici per chirurgia, Forbici per dissezione



STANDARD

10,5 cm, 4 ¹ / ₄ "	75-1018-10
11,5 cm, 4 ¹ / ₂ "	75-1018-11
13,0 cm, 5"	75-1018-13
14,5 cm, 5 ³ / ₄ "	75-1018-14
15,5 cm, 6"	75-1018-15
16,5 cm, 6 ¹ / ₂ "	75-1018-16
17,5 cm, 6 ⁵ / ₈ "	75-1018-17
18,5 cm, 7 ¹ / ₄ "	75-1018-18
20,0 cm, 8"	75-1018-20



STANDARD

10,5 cm, 4 ¹ / ₄ "	75-1020-10
11,5 cm, 4 ¹ / ₂ "	75-1020-11
13,0 cm, 5"	75-1020-13
14,5 cm, 5 ³ / ₄ "	75-1020-14
15,5 cm, 6"	75-1020-15
16,5 cm, 6 ¹ / ₂ "	75-1020-16
17,5 cm, 6 ⁵ / ₈ "	75-1020-17
18,5 cm, 7 ¹ / ₄ "	75-1020-18
20,0 cm, 8"	75-1020-20



DEAVER

12,0 cm, 4 ³ / ₄ "	75-1021-12
13,0 cm, 5"	75-1021-13
14,5 cm, 5 ³ / ₄ "	75-1021-14



DEAVER

12,0 cm, 4 ³ / ₄ "	75-1022-12
13,0 cm, 5"	75-1022-13
14,5 cm, 5 ³ / ₄ "	75-1022-14

**Präparierscheren
Dissecting Scissors
Tijeras de disección**



DEAVER	
12,0 cm, 4 ³ / ₄ "	75-1023-12
13,0 cm, 5"	75-1023-13
14,5 cm, 5 ³ / ₄ "	75-1023-14

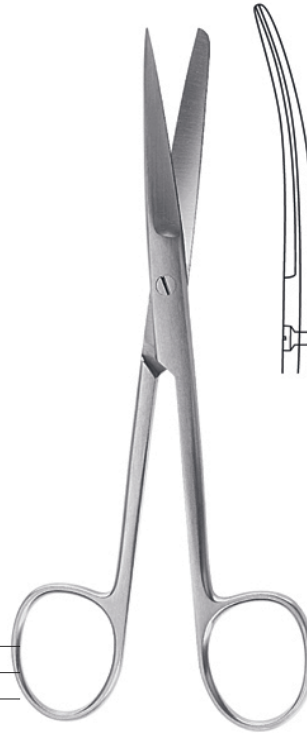

DEAVER	
12,0 cm, 4 ³ / ₄ "	75-1024-12
13,0 cm, 5"	75-1024-13
14,5 cm, 5 ³ / ₄ "	75-1024-14



DEAVER	
12,0 cm, 4 ³ / ₄ "	75-1025-12
13,0 cm, 5"	75-1025-13
14,5 cm, 5 ³ / ₄ "	75-1025-14



DEAVER	
12,0 cm, 4 ³ / ₄ "	75-1026-12
13,0 cm, 5"	75-1026-13
14,5 cm, 5 ³ / ₄ "	75-1026-14

Präparierscheren
Dissecting Scissors
Tijeras de disección
Forbici per dissezione



GRAZIL
13,0 cm, 5" **75-1027-13**
14,5 cm, 5³/₄" **75-1027-14**



GRAZIL
13,0 cm, 5" **75-1028-13**
14,5 cm, 5³/₄" **75-1028-14**



GRAZIL
13,0 cm, 5" **75-1029-13**
14,5 cm, 5³/₄" **75-1029-14**



GRAZIL
13,0 cm, 5" **75-1030-13**
14,5 cm, 5³/₄" **75-1030-14**

Präparierscheren
Dissecting Scissors
Tijeras de disección
Forbici per dissezione



GRAZIL
13,0 cm, 5"
14,5 cm, 5³/₄"

75-1031-13
75-1031-14



GRAZIL
13,0 cm, 5"
14,5 cm, 5³/₄"

75-1032-13
75-1032-14

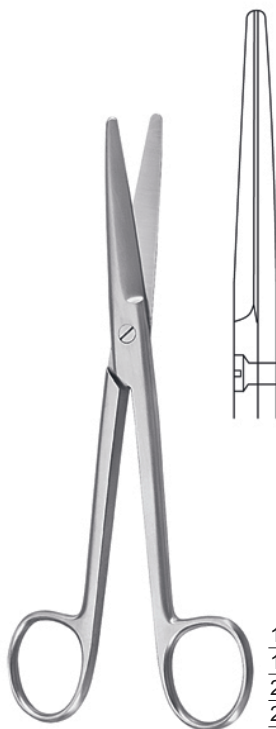

MAYO
14,5 cm, 5³/₄"
17,0 cm, 6³/₄"
23,0 cm, 9"
28,0 cm, 11"

75-1033-14
75-1033-17
75-1033-23
75-1033-28

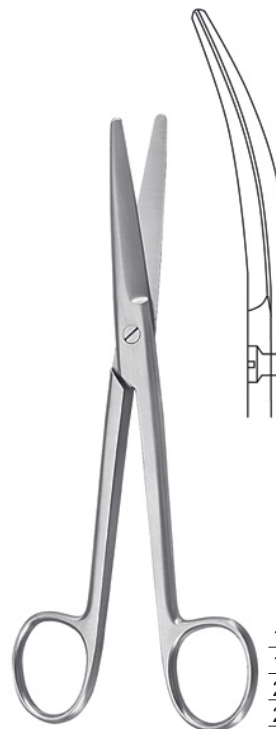

MAYO
14,5 cm, 5³/₄"
17,0 cm, 6³/₄"
23,0 cm, 9"
28,0 cm, 11"

75-1034-14
75-1034-17
75-1034-23
75-1034-28

Präparierscheren
Dissecting Scissors
Tijeras de disección
Forbici per dissezione

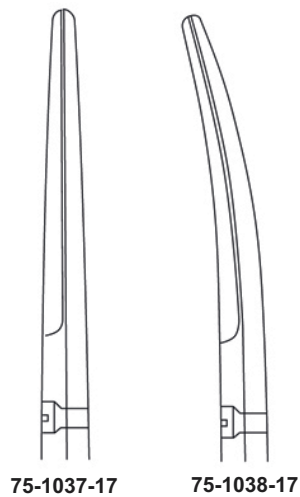

Präparierscheren
Dissecting Scissors
Tijeras de disección
Forbici per dissezione

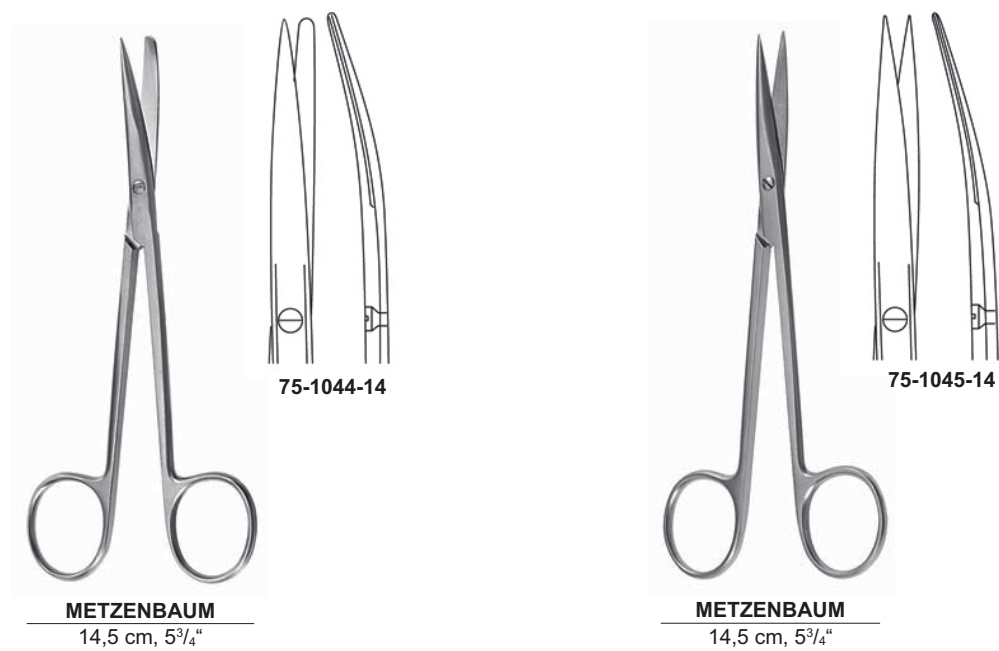
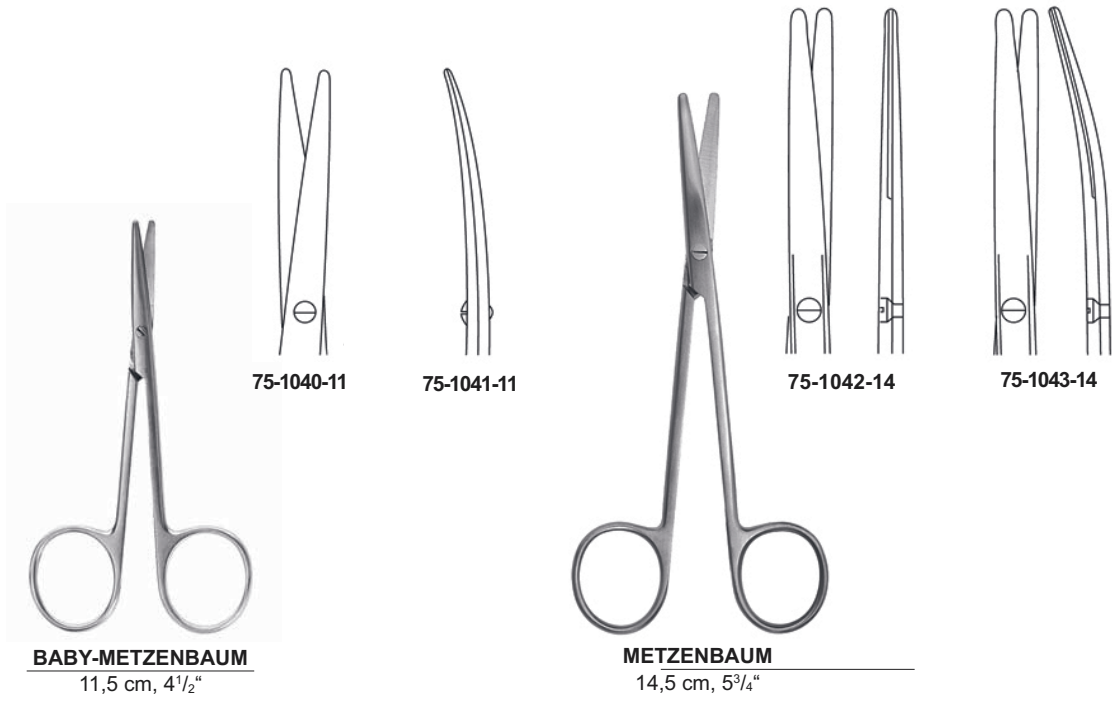

Präparierscheren
Dissecting Scissors
Tijeras de disección
Forbici per dissezione



METZENBAUM

18,0 cm, 7"	75-1046-18
20,0 cm, 8"	75-1046-20
23,0 cm, 9"	75-1046-23
25,0 cm, 10"	75-1046-25
28,0 cm, 11"	75-1046-28
30,0 cm, 12"	75-1046-30



METZENBAUM

18,0 cm, 7"	75-1047-18
20,0 cm, 8"	75-1047-20
23,0 cm, 9"	75-1047-23
25,0 cm, 10"	75-1047-25
28,0 cm, 11"	75-1047-28
30,0 cm, 12"	75-1047-30



METZENBAUM



18,0 cm, 7"	75-1048-18
20,0 cm, 8"	75-1048-20
23,0 cm, 9"	75-1048-23
25,0 cm, 10"	75-1048-25
28,0 cm, 11"	75-1048-28
30,0 cm, 12"	75-1048-30



METZENBAUM

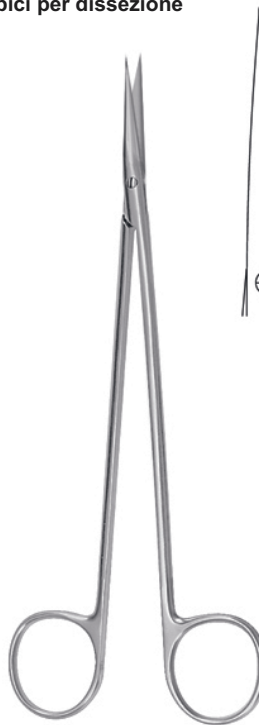

18,0 cm, 7"	75-1049-18
20,0 cm, 8"	75-1049-20
23,0 cm, 9"	75-1049-23
25,0 cm, 10"	75-1049-25
28,0 cm, 11"	75-1049-28
30,0 cm, 12"	75-1049-30

Präparierscheren
Dissecting Scissors
Tijeras de disección
Forbici per dissezione

18,0 cm, 7"	75-1050-18
20,0 cm, 8"	75-1050-20
23,0 cm, 9"	75-1050-23
25,0 cm, 10"	75-1050-25
28,0 cm, 11"	75-1050-28
30,0 cm, 12"	75-1050-30

METZENBAUM

18,0 cm, 7"	75-1051-18
20,0 cm, 8"	75-1051-20
23,0 cm, 9"	75-1051-23
25,0 cm, 10"	75-1051-25
28,0 cm, 11"	75-1051-28
30,0 cm, 12"	75-1051-30

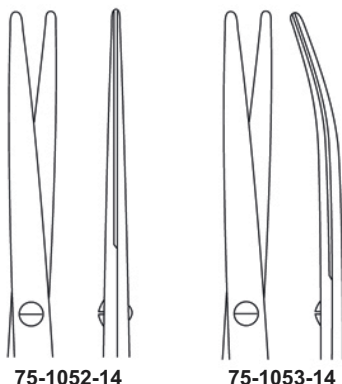

METZENBAUM

75-1052-14 **75-1053-14**

14,5 cm, 5 ³ / ₄ "	
--	--

METZENBAUM-FINO

18,0 cm, 7"	75-1054-18
20,0 cm, 8"	75-1054-20
23,0 cm, 9"	75-1054-23
25,0 cm, 10"	75-1054-25
28,0 cm, 11"	75-1054-28
30,0 cm, 12"	75-1054-30

METZENBAUM-FINO

Präparierscheren
Dissecting Scissors
Tijeras de disección
Forbici per dissezione

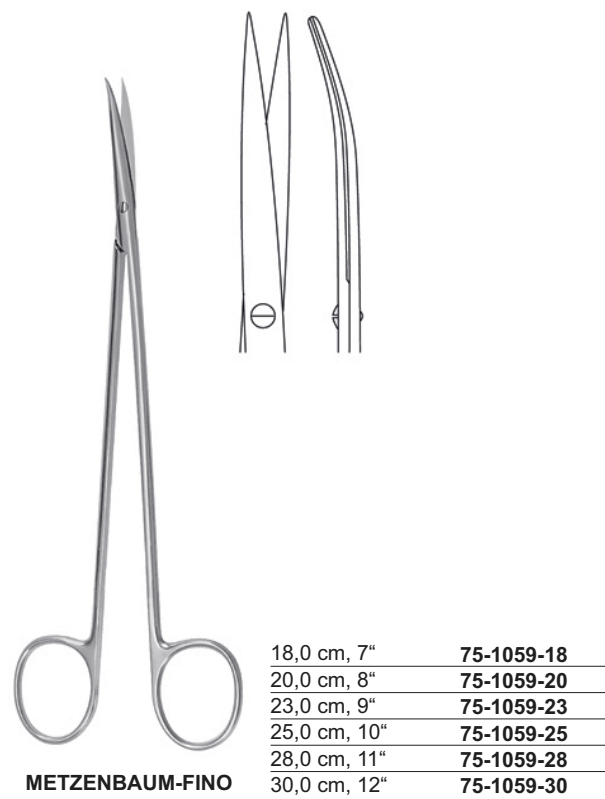
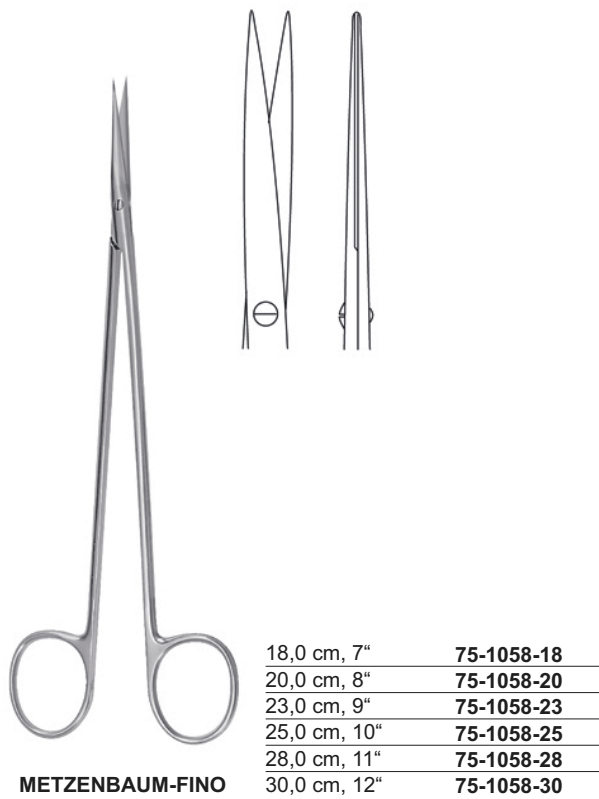
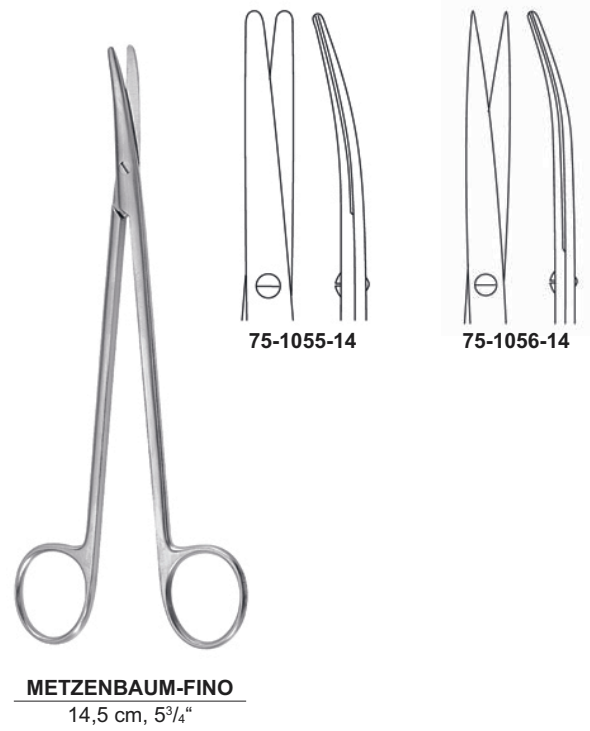
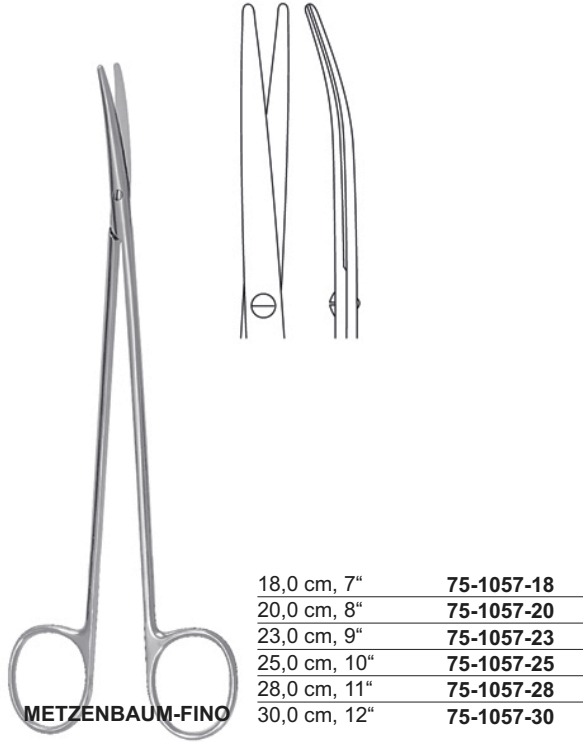

Präparierscheren
Dissecting Scissors
Tijeras de disección
Forbici per dissezione

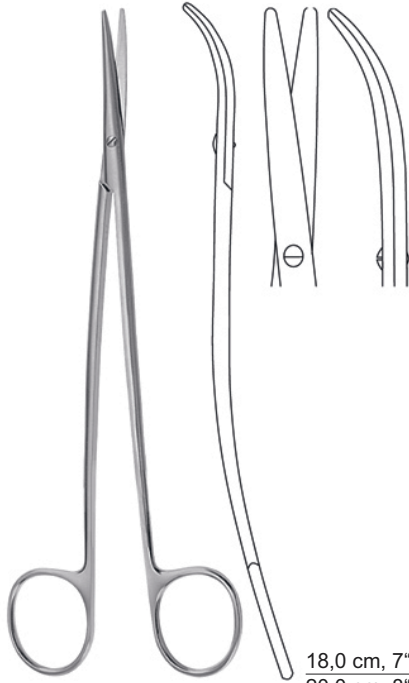

METZENBAUM-FINO S

18,0 cm, 7"	75-1060-18
20,0 cm, 8"	75-1060-20
23,0 cm, 9"	AK-1060-23

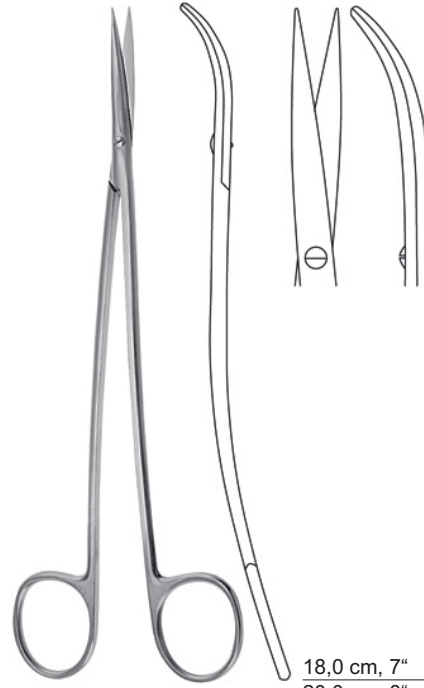

METZENBAUM-FINOS

18,0 cm, 7"	75-1061-18
20,0 cm, 8"	75-1061-20
23,0 cm, 9"	75-1061-23



METZENBAUM-LAHEY

14,0 cm, 5 1/2"	75-1062-14
-----------------	-------------------

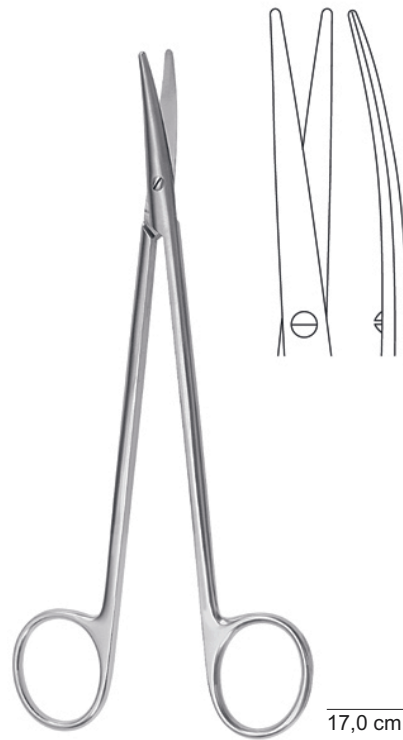

TOENNIS-ADSON

17,0 cm, 6 3/4"	75-1063-17
-----------------	-------------------

Präparierscheren
Dissecting Scissors
Tijeras de disección
Forbici per dissezione



BABY-LEXER
10,0 cm, 4"



LEXER 16,0 cm, 6¹/₄" **75-1066-16**
21,0 cm, 8¹/₄" **75-1066-21**



LEXER 16,0 cm, 6¹/₄" **75-1069-16**
21,0 cm, 8¹/₄" **75-1069-21**

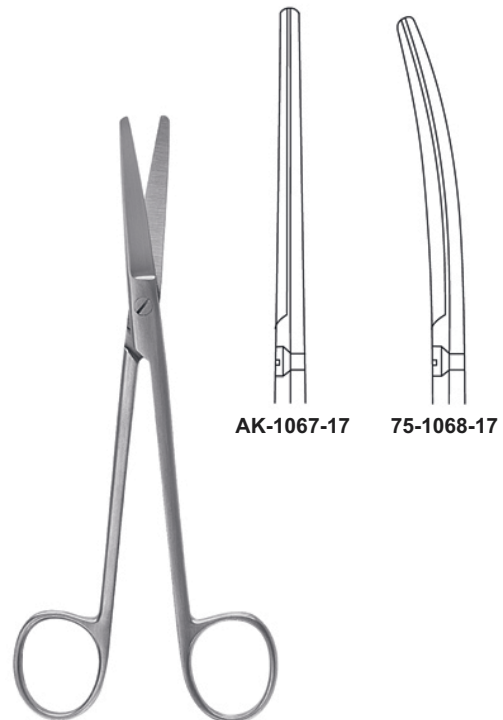

MIXTER
17,0 cm, 6³/₄"

Präparierscheren, feine chirurgische Scheren
 Dissecting Scissors, fine surgical scissors
 Tijeras de disección, tijeras finas para cirugía
 Forbici per dissezione, forbici fine per chirurgia



KILNER (RAGNELL)

12,0 cm, 4 ³ / ₄ "	75-1070-12
15,0 cm, 6"	75-1070-15
18,0 cm, 7"	75-1070-18
20,0 cm, 8"	75-1070-20



KILNER (RAGNELL)

12,0 cm, 4 ³ / ₄ "	75-1071-12
15,0 cm, 6"	75-1071-15
18,0 cm, 7"	75-1071-18
20,0 cm, 8"	75-1071-20



REYNOLDS

15,0 cm, 6"	75-1072-15
18,0 cm, 7"	75-1072-18



REYNOLDS

15,0 cm, 6"	75-1073-15
18,0 cm, 7"	75-1073-18
20,0 cm, 8"	75-1073-20
23,0 cm, 9"	75-1073-23
25,0 cm, 10"	75-1073-25

Feine chirurgische Scheren
Fine surgical scissors
Tijeras finas para cirugía
Forbici fine per chirurgia



19,0 cm, 7½"
75-1074-19

25,0 cm, 10"
75-1075-25

THOREK



75-1076-15

75-1077-15

15,0 cm, 6"

Nerv-Präparierscheren
Nerve dissecting scissors
Tijeras para nervios
Forbici per dissezione di nervi

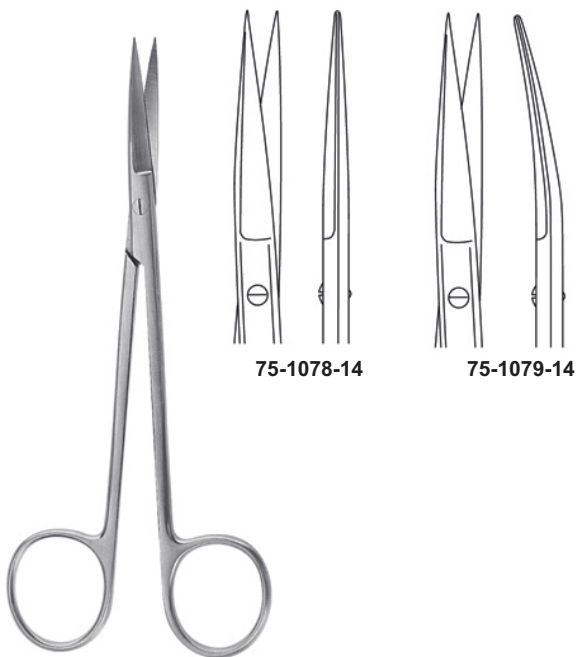

75-1078-14

75-1079-14

SANVENERO
14,0 cm, 5½"

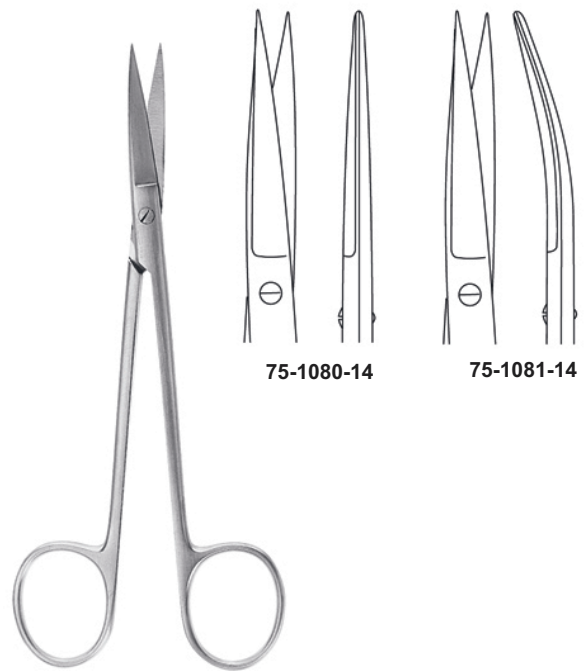

75-1080-14

75-1081-14

JOSEPH
14,0 cm, 5½"

Feine chirurgische Scheren
 Fine surgical scissors
 Tijeras finas para cirugía
 Forbici fine per chirurgia



WAGNER
 12,0 cm, 4³/₄"

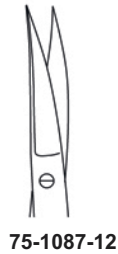
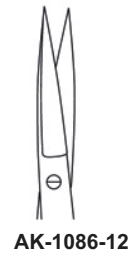
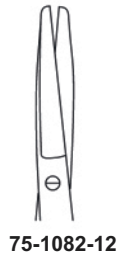

STRABISMUS
 11,5 cm, 4¹/₂"

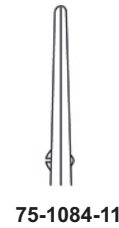

IRIS

9,0 cm, 4 ¹ / ₈ "	75-1088-09
10,5 cm, 4 ¹ / ₈ "	75-1088-10
11,5 cm, 4 ¹ / ₂ "	75-1088-11



IRIS

9,0 cm, 4 ¹ / ₈ "	75-1089-09
10,5 cm, 4 ¹ / ₈ "	75-1089-10
11,5 cm, 4 ¹ / ₂ "	75-1089-11

Feine chirurgische Scheren
Fine surgical scissors
Tijeras finas para cirugía
Forbici fine per chirurgia



IRIS

10,5 cm, 4¹/₈"
11,5 cm, 4¹/₂"

75-1090-10
75-1090-11



IRIS

10,5 cm, 4¹/₈"
11,5 cm, 4¹/₂"

75-1091-10
75-1091-11



11,5 cm, 4¹/₂"
75-1092-11



11,5 cm, 4¹/₂"
75-1093-11

Feine chirurgische Scheren
Fine surgical scissors
Tijeras finas para cirugía
Forbici fine per chirurgia



75-1094-12

12,0 cm, 4³/₄"



75-1095-12



MOD. BONN
8,0 cm, 3¹/₄"
75-1096-08



MOD. BONN
8,0 cm, 3¹/₄"
75-1097-08



MOD. BONN
8,0 cm, 3¹/₄"
75-1098-08

Feine chirurgische Scheren
Fine surgical scissors
Tijeras finas para cirugía
Forbici fine per chirurgia

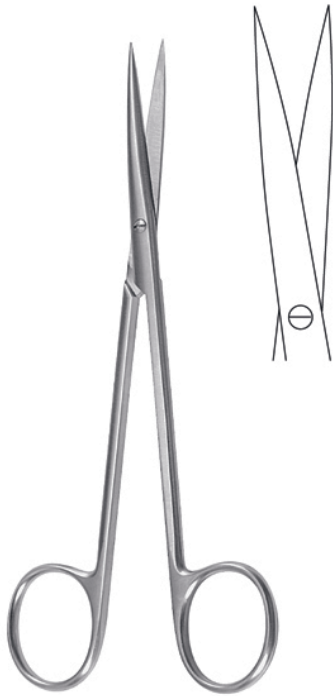

BROPHY (SULLIVAN)
14,0 cm, 5 1/2"
75-1099-14



BROPHY (SULLIVAN)
14,0 cm, 5 1/2"
75-1100-14

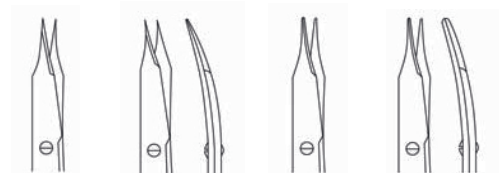

10,5 cm, 4 1/8"	75-1101-10	75-1102-10	75-1103 -10	75- 1104-10
11,5 cm, 4 1/2"	75-1101-11	75-1102-11	75-1103-11	75-1104-11

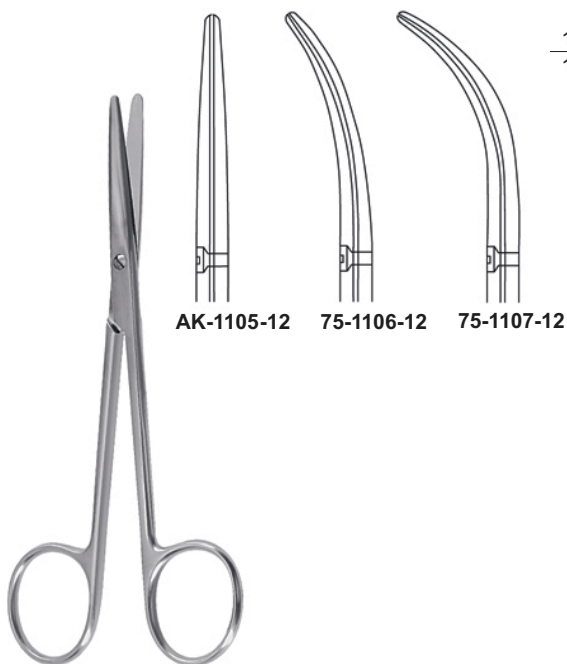

LANDOLT
12,5 cm, 5"



STEVENS

Chirurgische Scheren
Surgical scissors
Tijeras para cirugía
Forbici per chirurgia



Inzisionsscheren
Incision scissors
Tijeras para incisión
Forbici vascolare e per fistole

13,0 cm, 5" **75-1108-13**
14,5 cm, 5¾" **75-1108-14**



Inzisionsscheren
Incision scissors
Tijeras para incisión
Forbici vascolare e per fi stole

75-1109-16
16,5 cm, 36½"



RICHTER
14,5 cm, 5¾"
75-1110-14



LAWSON TAIT
12,5 cm, 5"
75-1111-12



FERGUSON
16,5 cm, 6¼" **75-1112-16**
18,0 cm, 7" **75-1112-18**



TOENNIS
18,0 cm, 7"
75-1113-18

Chirurgische Scheren, Ligaturscheren
Surgical scissors, Ligature Scissors
Tijeras para cirugía, Tijeras para ligaduras
Forbici per chirurgia, Forbici per legature



TOENNIS
18,0 cm, 7"
75-1114-18



HALLE
19,0 cm, 7½"
75-1115-19



FOMON
15,0 cm, 6"
75-1116-15



SPENCER
9,0 cm, 4⅛" **75-1117-09**
10,5 cm, 4⅛" **75-1117-10**
13,0 cm, 5" **75-1117-13**



LITTAUER
11,5 cm, 4¼" **75-1118-11**
14,0 cm, 5½" **75-1118-14**



14,5 cm, 5¾"
75-1119-14

18,0 cm, 7"
75-1120-18

Ligaturscheren, Neurochirurgische Scheren
Ligature Scissors, Neurosurgical Scissors
Tijeras para ligaduras, Tijeras para Neurocirugía
Forbici per legature, Forbici per Neurochirurgia

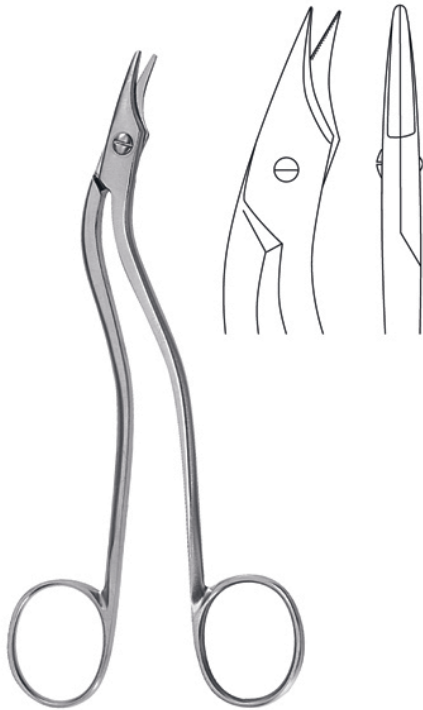

HEATH
16,0 cm, 6¹/₄"
75-1121-16



NORTHBENT
9,0 cm, 3¹/₂"
75-1122-09



NORTHBENT
13,0 cm, 5"
75-1123-13



EISELSBERG
12,0 cm, 4³/₄"
75-1124-12

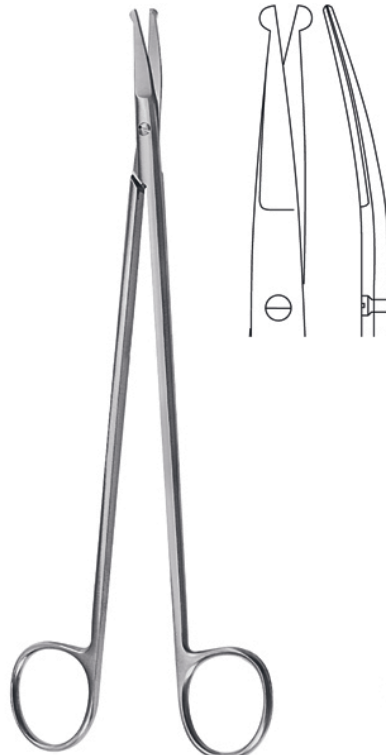

STRULLY
22,0 cm, 8⁵/₈"
75-1125-22

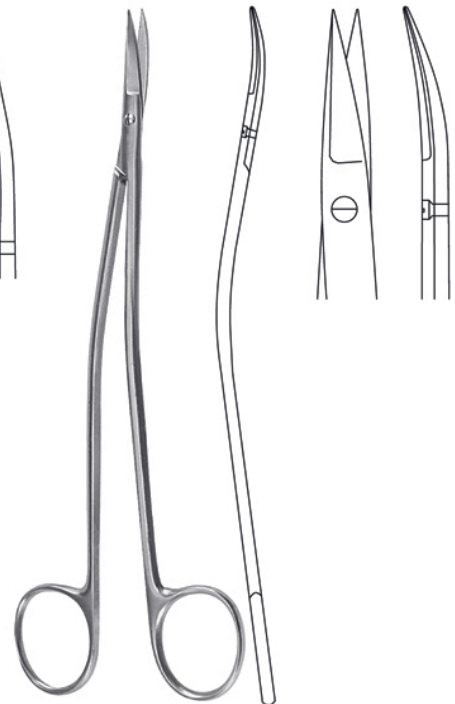

DANDY
17,0 cm, 6³/₄"
75-1126-17

Neurochirurgische Scheren, Tonsillenscheren, Nasenscheren
 Neurosurgical Scissors, Tonsil Scissors, Nasal Scissors
 Tijeras para Neurocirugía, Tijeras para amígdalas, Tijeras para el tabique nasal
 Forbici per Neurochirurgia, Forbici per tonsille, Forbici per il setto nasale

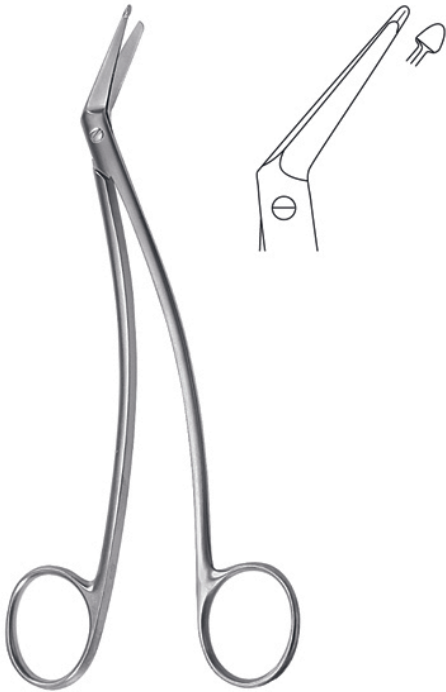

SCHMIEDEN-TAYLOR
17,0 cm, 6³/₄"
75-1127-17

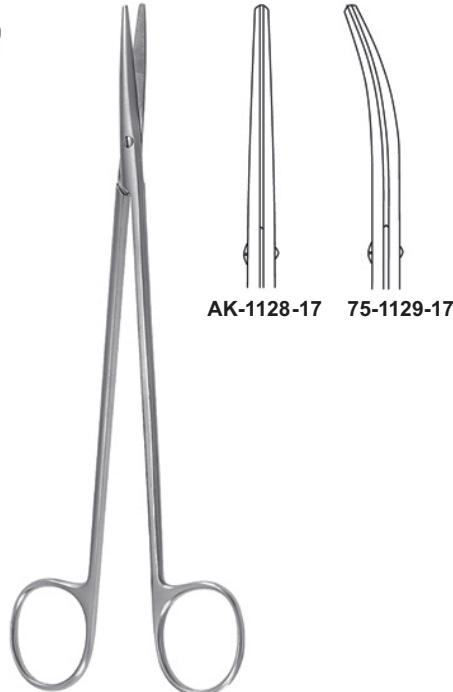

LINCOLN
17,0 cm, 6³/₄"



HEYMANN
18,0 cm, 7"
75-1130-18

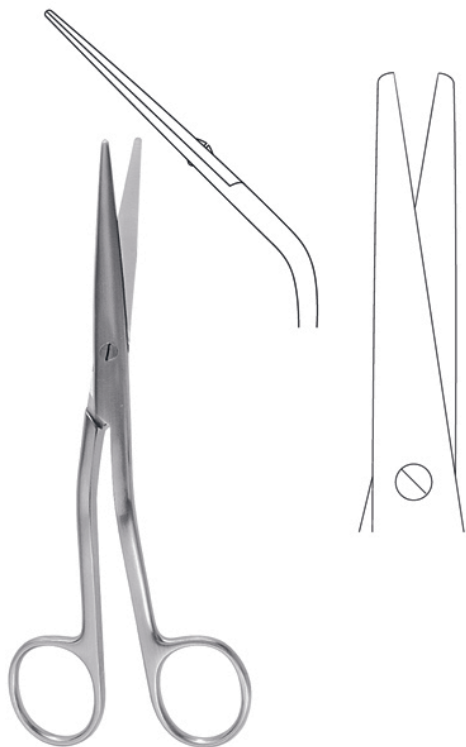

COTTLE
16,0 cm, 6¹/₄"
75-1131-16

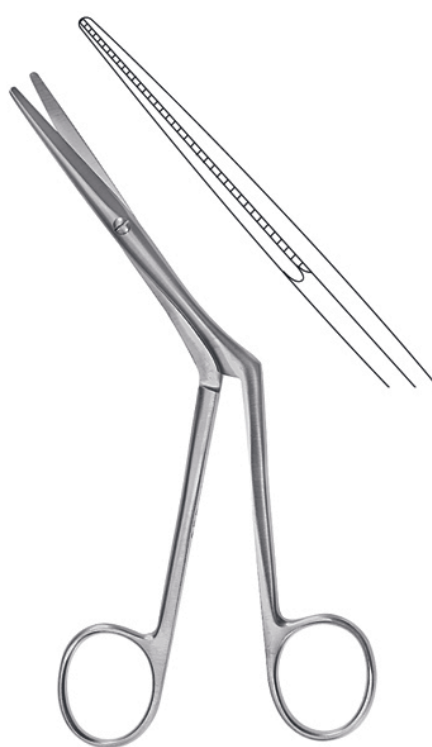

KIRSTEN
18,0 cm, 7"
75-1132-18



CAPLAN
22,0 cm, 8⁵/₈"
75-1133-22

Tonsillenscheren, Nasenscheren, Gefäßscheren
 Tonsil Scissors, Nasal Scissors, Vascular Scissors
 Tijeras para amígdalas, Tijeras para el tabique nasal, Tijeras vasculares
 Forbici per tonsille, Forbici per il setto nasale, Forbici vascolari



BOETTCHER
 18,0 cm, 7"
 75-1134-18

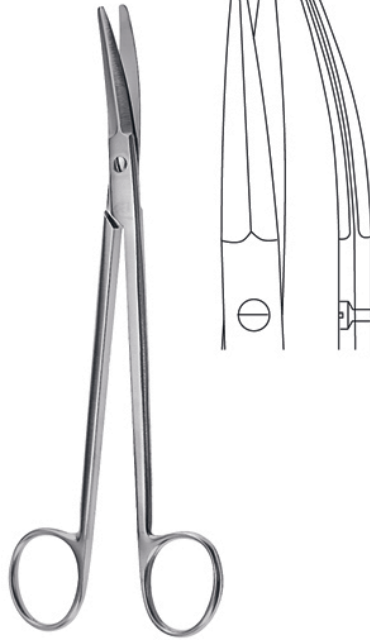

PRINCE
 17,5 cm, 6⁵/₈"
 75-1135-17

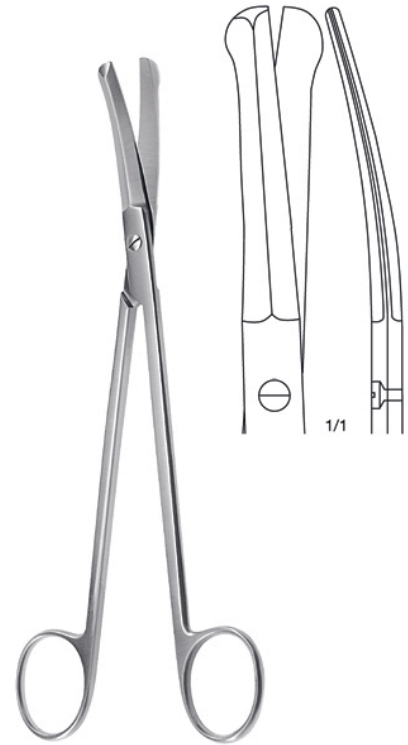

GOOD
 19,0 cm, 7¹/₂"
 75-1136-19



CARTILAGE
 20,0 cm, 8"
 75-1137-20



DE BAKEY

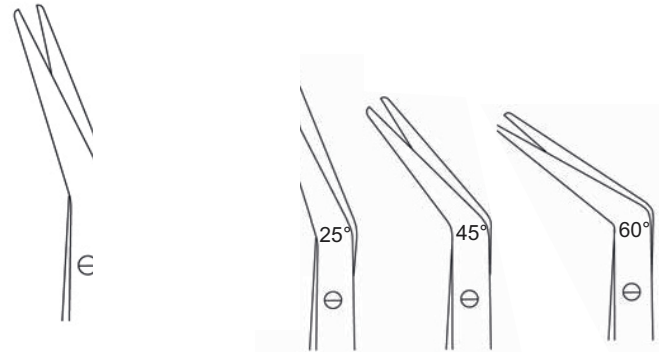

17,5 cm, 6 ⁵ / ₈ "	75-1138-25	75-1143-45	75-1148-60
19,5 cm, 7 ³ / ₄ "	75-1139-25	75-1144-45	75-1149-60
21,0 cm, 8 ¹ / ₄ "	75-1140-25	75-1145-45	75-1150-60
23,0 cm, 9"	75-1141-25	75-1146-45	75-1151-60
28,0 cm, 11"	75-1142-25	75-1147-45	75-1152-60

Gefäßscheren
Vascular Scissors
Tijeras vasculares
Forbici vascolari

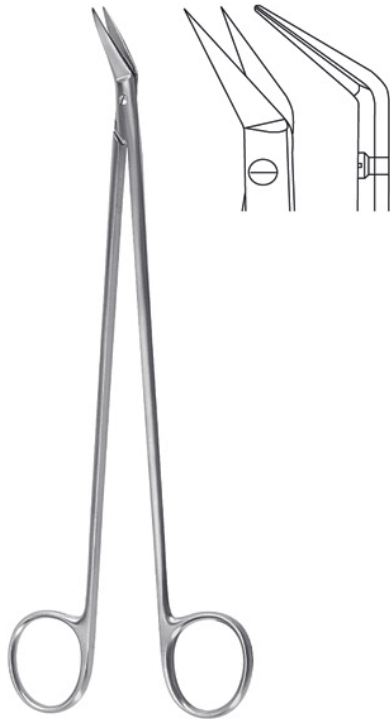

POTTS-SMITH
18,0 cm, 7"
75-1143-18

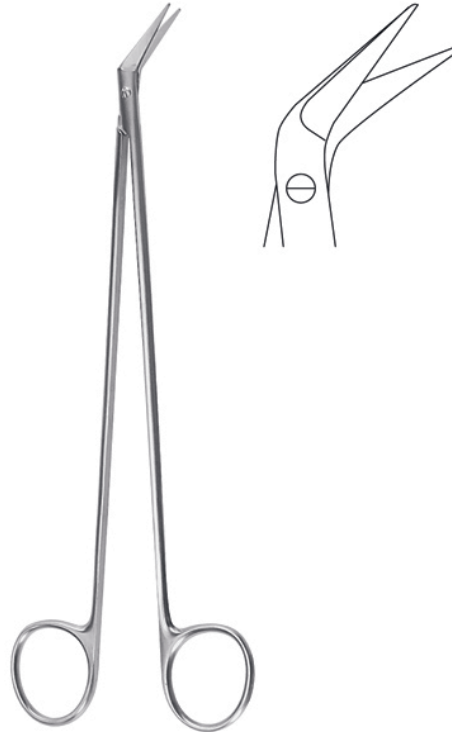

POTTS DE MARTEL
21,0 cm, 8¹/₄" 75-1144-21
24,0 cm, 9¹/₂" 75-1144-24



DIETHRICH-HEGEMANN
19,0 cm, 7¹/₂"

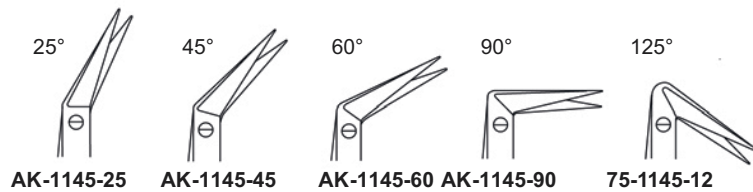

Gefäßscheren
Vascular Scissors
Tijeras vasculares
Forbici vascolari



DIETHRICH
20,0 cm, 7 1/2"
75-1148-12

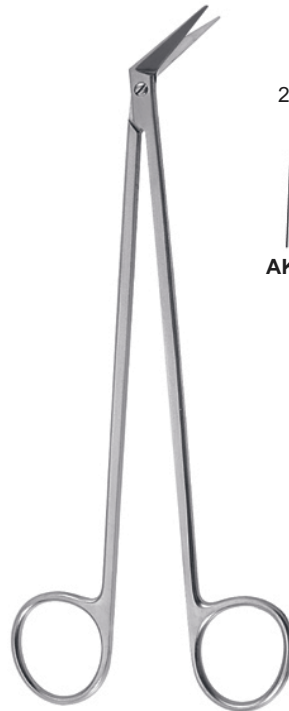

POTTS-SMITH
19,0 cm, 7 1/2"

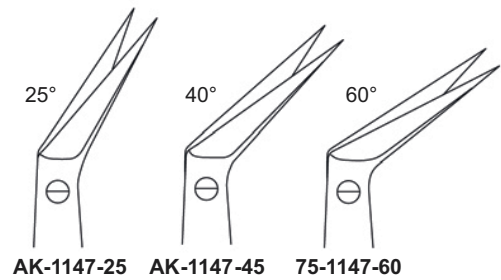

AK-1147-25 AK-1147-45 75-1147-60

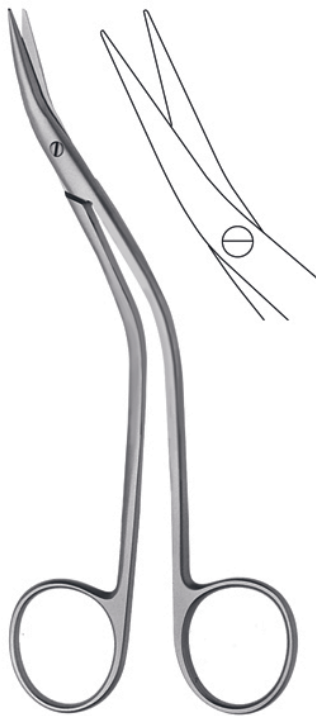

DE BAKEY
15,5 cm, 6"
75-1149-15

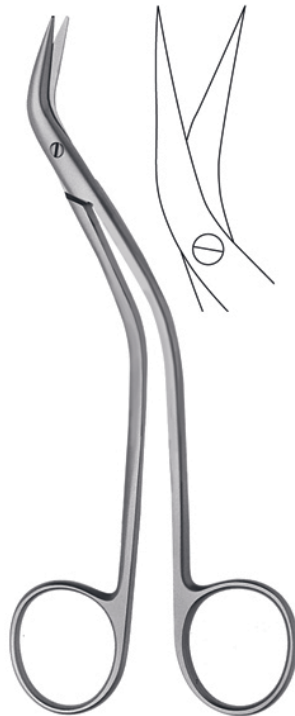

DE BAKEY
15,5 cm, 6"
75-1150-15

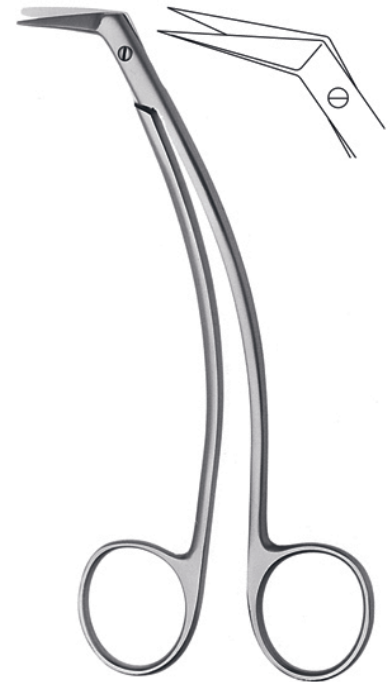

DE BAKEY
15,5 cm, 6"
75-1151-15

Gefäßscheren, Gynäkologische Scheren
Vascular Scissors, Gynecology scissors
Tijeras vasculares, Tijeras para ginecología
Forbici vascolari, Forbici per ginecologia



MC INDOE
19,0 cm, 7½"
75-1152-19



geknöpftes Blatt
probe-pointed blade
punta botonda
lame bottonuta

11,5 cm, 4½"
75-1153-11



CRAFOORD
30,0 cm, 12"
75-1154-30



SATINSKY
15,5 cm, 9⅝"
75-1155-24



KLINGENBERG-LOTH
23,0 cm, 9"
75-1162-23



SIMS

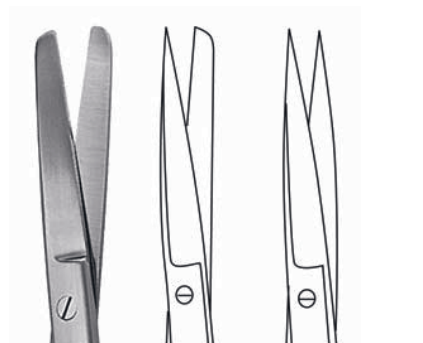

20,0 cm, 8"	AK-1156-20	75-1157-20	AK-1158-20
23,0 cm, 9"	AK-1159-23	75-1160-23	AK-1161-23

Gynäkologische Scheren
Gynecology scissors
Tijeras para ginecología
Forbici per ginecologia



SIMS

20,0 cm, 8"
23,0 cm, 9"



AK-1163-20 AK-1164-20 AK-1165 -20
AK-1166-23 AK-1167-23 AK-1168 -23

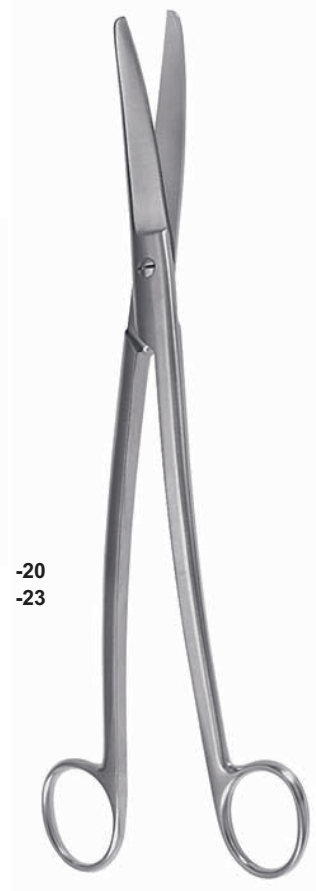

SIEBOLD
24,0 cm, 9 1/2"
75-1169-24



BOZEMANN
22,0 cm, 8 3/4"
75-1170-22



DOYEN

16,0 cm, 6 1/4" AK-1171-16 AK-1172-16 AK- 1173-16
17,5 cm, 6 5/8" AK-1174-17 AK-1175-17 75-1176-16



KELLY

16,0 cm, 6 1/4" 75-1177-16
18,0 cm, 7" 75-1177-18

Fistelscheren
Fistula scissors
Tijeras para fistulas
Forbici per fistole

Gynäkologische Scheren, Darmscheren
Gynecology scissors, Enterotomy Scissors
Tijeras para ginecología, Tijeras enterótomos
Forbici per ginecologia, Forbici per enterotomia



Fistelscheren
Fistula scissors
Tijeras para fistulas
Forbici per fistole

KELLY

16,0 cm, 6¹/₄" **75-1179-16**
18,0 cm, 7" **75-1179-18**



WERTHEIM

19,5 cm, 7³/₄" **75-1180-19**
22,5 cm, 8³/₄" **75-1180-23**



75-1178-18

DUBOIS

27,0 cm, 10⁵/₈" **75-1181-18**



DARMSCHERE
21,0 cm, 8¹/₄"
75-1182-21



DARMSCHERE
21,0 cm, 8¹/₄"
75-1183-21



**DARMSCHERE
GEKNÖPFT**
21,0 cm, 8¹/₄"
75-1184-21



LLOYD-DAVIES
27,0 cm, 10⁵/₈"
75-1185-27



Lungenlappen- und Rektumscheren, Lungenscheren, Dammscheren
 Lobectomy and Rectal Scissors, Lobectomy Scissors, Episiotomy Scissors
 Tijeras para lobectomía y recto, Tijera para lobectomía, Tijeras para episiotomía
 Forbici per lobo polmonare e per il retto, Forbici per lobo, Forbici per episiotomia

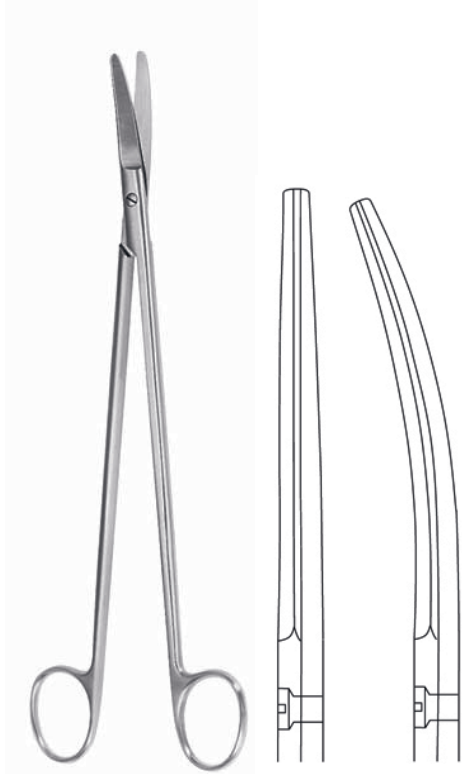

STELZNER 75-1186-31 75-1187-31
 31,0 cm, 12³/₄"

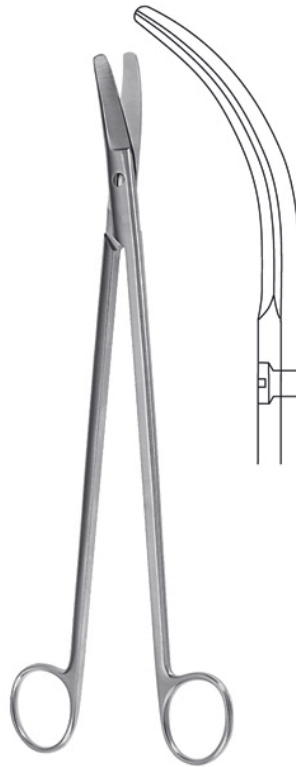

RECTAL
 32,5 cm, 12³/₄"
 75-1188-32



WILLAUER
 25,0 cm, 9³/₄" 75-1189-25
 28,0 cm, 11" 75-1189-28

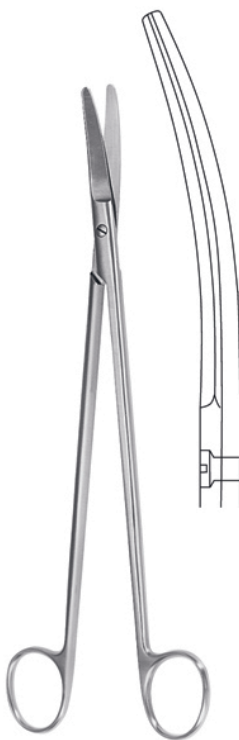

WILLAUER
 25,0 cm, 9³/₄" 75-1190-25
 28,0 cm, 11" 75-1190-28



POTTS-SMITH
 19,0 cm, 7¹/₂"
 75-1191-19



FINOCHIETTO
 32,5 cm, 10⁵/₈"
 75-1192-27

Lungenscheren, Dammscheren, Nabelschnurscheren
 Lobectomy Scissors, Episiotomy Scissors, Umbilical Cord Scissors
 Tijera para lobectomía, Tijeras para episiotomía, Tijeras umbilicales
 Forbici per lobo, Forbici per episiotomia, Forbici ombelicali



WALDMANN
18,0 cm, 7"
75-1193-18



BRAUN-STADLER
14,5 cm, 5³/₄" 75-1194-14
20,0 cm, 8" 75-1194-20



EPISIOTOMIE SCHERE
20,0 cm, 8"
75-1195-20



MOD. USA
10,5 cm, 4¹/₈"
75-1196-10



BUSCH
13,5 cm, 5³/₈" 75-1197-13
16,0 cm, 6¹/₄" 75-1197-16



SCHUMACHER
16,0 cm, 16¹/₄"
75-1198-16

Drahtscheren, Verband- und Kleiderstoffscheren
Wire Scissors, Bandage and Cloth Scissors
Cizallas corta-alambres, Tijeras para vendajes y tela
Forbici taglia cavo, Forbici per bendaggi e vestiti



gezahnt
serrated
dentada
dentata

UNIVERSAL
12,0 cm, 4³/₄"
75-1200-12



LISTER

9,0 cm, 3 ¹ / ₂ "	75-1199-09
11,0 cm, 4 ³ / ₈ "	75-1199-11
14,0 cm, 5 ¹ / ₂ "	75-1199-14
18,0 cm, 7"	75-1199-18
20,0 cm, 8"	75-1199-20



LISTER

18,5 cm, 7 ¹ / ₄ "	75-1201-18
21,0 cm, 8 ¹ / ₄ "	75-1201-21



LISTER-EXCENTRIC

16,0 cm, 6 ¹ / ₄ "	75-1202-16
19,0 cm, 7 ¹ / ₂ "	75-1202-19

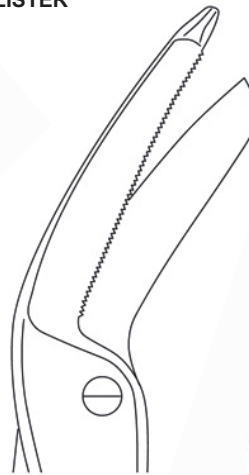

gezahnt
serrated
dentada
dentata



BERGMANN

23,0 cm, 9"	75-1203-23
-------------	-------------------

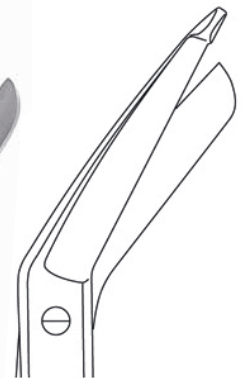

Verband- und Kleiderstoffscheren, Gipsscheren
Bandage and Cloth Scissors, Plaster-of-Paris Shears
Tijeras para vendajes y tela, Cizallas para escayolas
Forbici per bendaggi e vestiti, Cesoie per gessi



ESMARCH
20,0 cm, 8" **75-1204-20**
22,0 cm, 8⁵/₈" **75-1204-22**



KNOWLES
14,0 cm, 5¹/₂"
75-1205-14



gezahnt
serrated
dentada
dentata

BRUNS
24,0 cm, 9¹/₂"
75-1206-24
75-1207-24



LORENZ
23,0 cm, 9"
75-1208-23

bis 134°C autoklavierbar
autoclavable up to 134°C
esterilizable en autoclave hasta 134°C
Sterilizzabile in autoclave fino 134°C



SMITH
(MOD. USA)

16,0 cm, 6¹/₄" **75-1209-16**
18,0 cm, 7" **75-1209-18**
20,0 cm, 8" **75-1209-20**
23,0 cm, 9" **75-1209-23**



gezahnt
serrated
dentada
dentata

GIPSSCHERE
20,0 cm, 8"
75-1210-20



gezahnt
serrated
dentada
dentata

UNIVERSAL
14,0 cm, 5¹/₂" **75-1211-14**
16,0 cm, 6¹/₄" **75-1211-16**
18,0 cm, 7" **75-1211-18**

Chirurgische Scheren mit Hartmetallschneiden
Surgical Scissors with tungsten carbide edges
Tijeras para cirugía con filos de carburo tungsteno
Forbici per chirurgia con lame in carburo di tungsteno



STANDARD

14,5 cm, 5 ³ / ₄ "	75-1212-14-TC
16,5 cm, 6 ¹ / ₂ "	75-1212-16-TC
18,5 cm, 7 ¹ / ₄ "	75-1212-18-TC



STANDARD

14,5 cm, 5 ³ / ₄ "	75-1213-14-TC
16,5 cm, 6 ¹ / ₂ "	75-1213-16-TC
18,5 cm, 7 ¹ / ₄ "	75-1213-18-TC



STANDARD

14,5 cm, 5 ³ / ₄ "	75-1214-14-TC
16,5 cm, 6 ¹ / ₂ "	75-1214-16-TC
18,5 cm, 7 ¹ / ₄ "	75-1214-18-TC



STANDARD

14,5 cm, 5 ³ / ₄ "	75-1215-14-TC
16,5 cm, 6 ¹ / ₂ "	75-1215-16-TC
18,5 cm, 7 ¹ / ₄ "	75-1215-18-TC



STANDARD

14,5 cm, 5 ³ / ₄ "	75-1216-14-TC
16,5 cm, 6 ¹ / ₂ "	75-1216-16-TC
18,5 cm, 7 ¹ / ₄ "	75-1216-18-TC



STANDARD

14,5 cm, 5 ³ / ₄ "	75-1217-14-TC
16,5 cm, 6 ¹ / ₂ "	75-1217-16-TC
18,5 cm, 7 ¹ / ₄ "	75-1217-18-TC

Chirurgische Scheren mit Hartmetallschneiden
Surgical Scissors with tungsten carbide edges
Tijeras para cirugía con filos de carburo tungsteno
Forbici per chirurgia con lame in carburo di tungsteno



MAYO

14,5 cm, 5 ³ / ₄ "	75-1218-14 -TC
17,0 cm, 6 ³ / ₄ "	75-1218-17-TC
23,0 cm, 9"	75-1218-23-TC



MAYO

14,5 cm, 5 ³ / ₄ "	75-1219-14 -TC
17,0 cm, 6 ³ / ₄ "	75-1219-17-TC
23,0 cm, 9"	75-1219-23-TC



MAYO-STILLE

15,0 cm, 6"	75-1220-15 -TC
17,0 cm, 6 ³ / ₄ "	75-1220-17 -TC



MAYO-STILLE

15,0 cm, 6"	75-1221-15-TC
17,0 cm, 6 ³ / ₄ "	75-1221-17-TC



LEXER

16,0 cm, 6 ¹ / ₄ "	75-1222-16-TC
21,0 cm, 8 ¹ / ₄ "	AK-1222-21-TC



LEXER

16,0 cm, 6 ¹ / ₄ "	75-1223-16 -TC
21,0 cm, 8 ¹ / ₄ "	75-1223-21 -TC

Präparierscheren mit Hartmetallschneiden
Dissecting Scissors with tungsten carbide edges
Tijeras para disección con filos de carburo tungsteno
Forbici per dissezione con lame in carburo di tungsteno

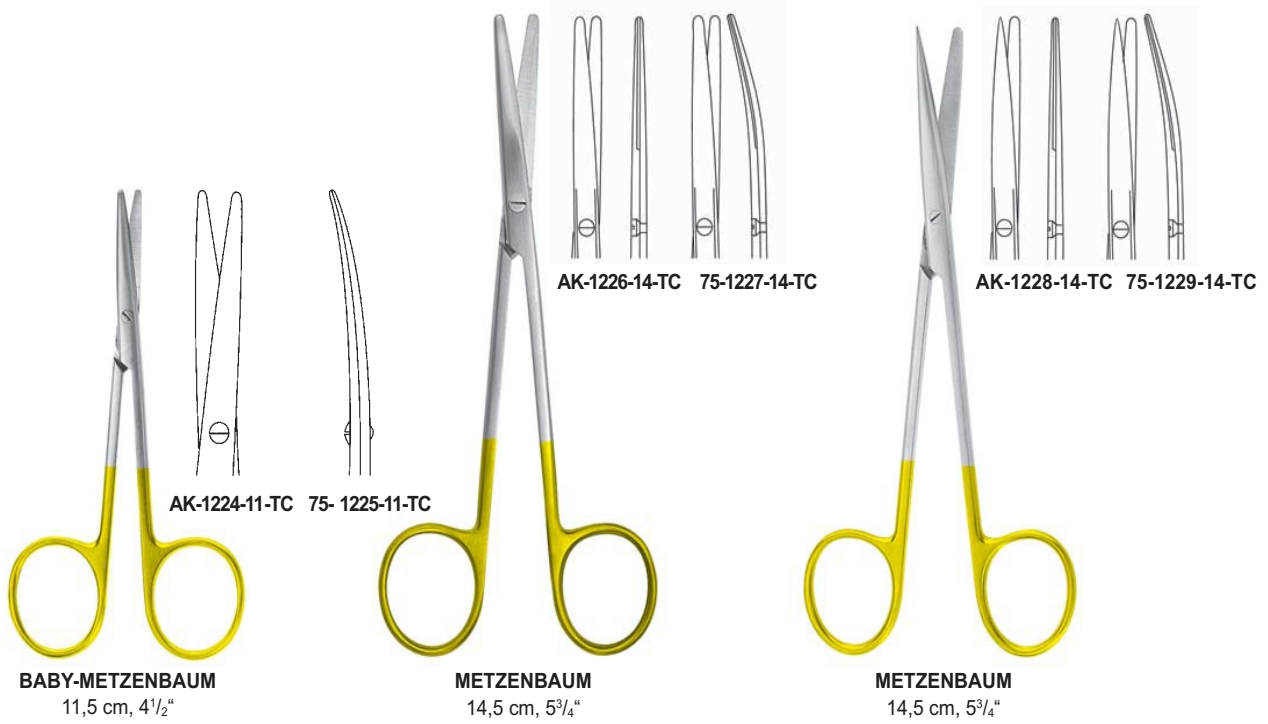



18,0 cm, **775-1234-18-TC**
 20,0 cm, **875-1234-20-TC**
 23,0 cm, **975-1234-23-TC**
 25,0 cm, **10"75-1234-25-TC**
 28,0 cm, **11"75-1234-28-TC**
 30,0 cm, **12" 75-1234-30-TC**

METZENBAUM

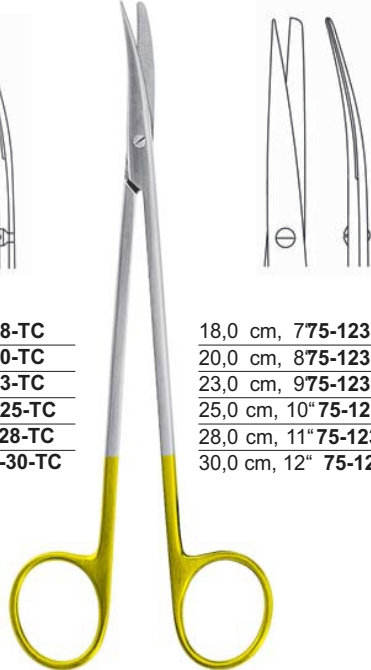

18,0 cm, **775-1235-18-TC**
 20,0 cm, **875-1235-20-TC**
 23,0 cm, **975-1235-23-TC**
 25,0 cm, **10"75-1235-25-TC**
 28,0 cm, **11"75-1235-28-TC**
 30,0 cm, **12" 75-1235-30-TC**

METZENBAUM

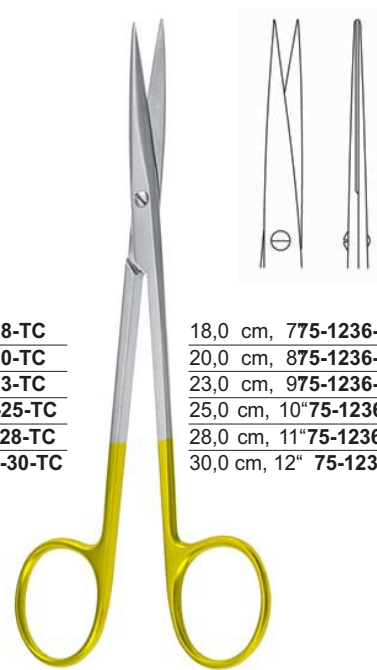

18,0 cm, **775-1236-18-TC**
 20,0 cm, **875-1236-20-TC**
 23,0 cm, **975-1236-23-TC**
 25,0 cm, **10"75-1236-25-TC**
 28,0 cm, **11"75-1236-28-TC**
 30,0 cm, **12" 75-1236-30-TC**

METZENBAUM



18,0 cm, **7" 75-1237-18-TC**
 20,0 cm, **8" 75-1237-20-TC**
 23,0 cm, **9" 75-1237-23-TC**
 25,0 cm, **10" 75-1237-25-TC**
 28,0 cm, **11" 75-1237-28-TC**
 30,0 cm, **12" 75-1237-30-TC**

METZENBAUM

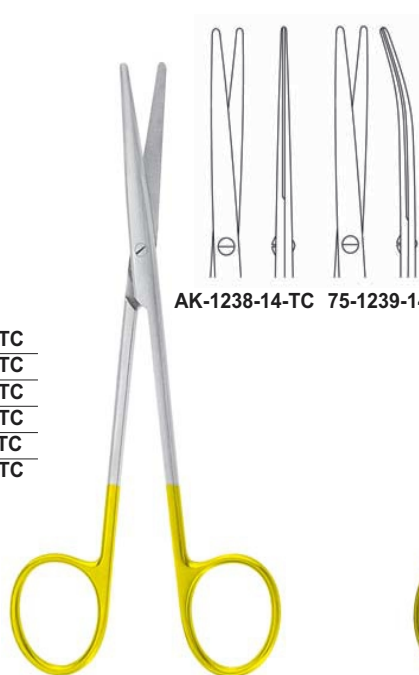

AK-1238-14-TC 75-1239-14-TC

METZENBAUM-FINO

14,5 cm, 5³/₄"

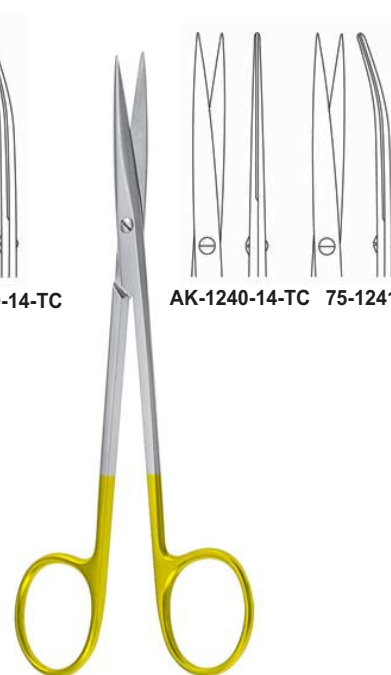

AK-1240-14-TC 75-1241-14-TC

METZENBAUM-FINO

14,5 cm, 5³/₄"

Präparierscheren mit Hartmetallschneiden
Dissecting Scissors with tungsten carbide edges
Tijeras para disección con filos de carburo tungsteno
Forbici per dissezione con lame in carburo di tungsteno

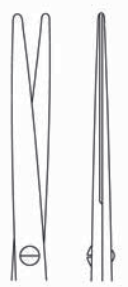
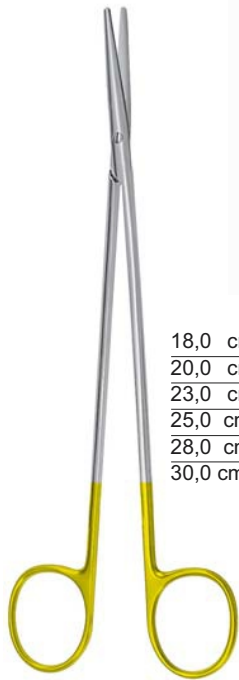

18,0 cm, 7" **75-1242-18-TC**
 20,0 cm, 8" **75-1242-20-TC**
 23,0 cm, 9" **75-1242-23-TC**
 25,0 cm, 10" **75-1242-25-TC**
 28,0 cm, 11" **75-1242-28-TC**
 30,0 cm, 12" **75-1242-30-TC**

METZENBAUM-FINO

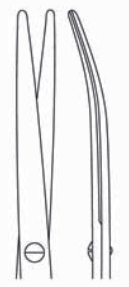
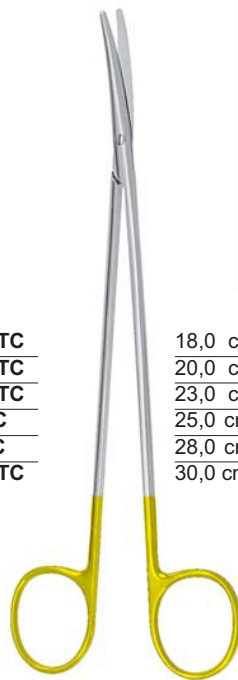

18,0 cm, **775-1243-18-TC**
 20,0 cm, **875-1243-20-TC**
 23,0 cm, **975-1243-23-TC**
 25,0 cm, 10" **75-1243-25-TC**
 28,0 cm, 11" **75-1243-28-TC**
 30,0 cm, 12" **75-1243-30-TC**

METZENBAUM-FINO



18,0 cm, **775-1244-18-TC**
 20,0 cm, **875-1244-20-TC**
 23,0 cm, **975-1244-23-TC**
 25,0 cm, 10" **75-1244-25-TC**
 28,0 cm, 11" **75-1244-28-TC**
 30,0 cm, 12" **75-1244-30-TC**

METZENBAUM-FINO

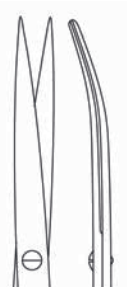

18,0 cm, 7" **75-1245-18-TC**
 20,0 cm, 8" **75-1245-20-TC**
 23,0 cm, 9" **75-1245-23-TC**
 25,0 cm, 10" **75-1245-25-TC**
 28,0 cm, 11" **75-1245-28-TC**
 30,0 cm, 12" **75-1245-30-TC**

METZENBAUM-FINO



METZENBAUM-LAHEY
 14,0 cm, 5 1/2"
75-1246-14-TC

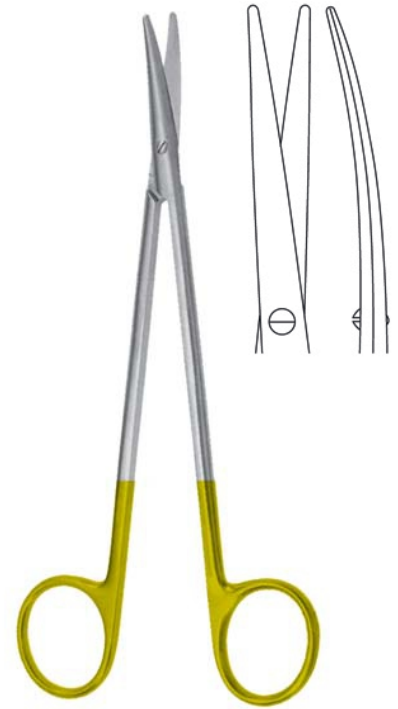

TOENNIS-ADSON
 17,0 cm, 6 3/4"
75-1247-17-TC

Präparierscheren mit Hartmetallschneiden
 Dissecting Scissors with tungsten carbide edges
 Tijeras para disección con filos de carburo tungsteno
 Forbici per dissezione con lame in carburo di tungsteno



18,0 cm, 7" **75-1248-18-TC**
 20,0 cm, 8" **75-1248-20-TC**
 23,0 cm, 9" **75-1248-23-TC**

METZENBAUM-FINO S



18,0 cm, 7" **75-1249-18-TC**
 20,0 cm, 8" **75-1249-20-TC**
 23,0 cm, 9" **75-1249-23-TC**

METZENBAUM-FINO S



REYNOLDS
 15,0 cm, 6"
75-1250-15-TC



REYNOLDS
 15,0 cm, 6"
75-1251-15-TC



HYSTEREKTOMY
 25,5 cm, 10"
75-1252-25-TC



HYSTEREKTOM
 Y 25,0 cm, 9³/₄"
75-1253-25-TC

Gynäkologische Scheren mit Hartmetallschneiden
 Gynecology Scissors with tungsten carbide edges
 Tijeras para ginecología con filos de carburo tungsteno
 Forbici per ginecologia con lame in carburo di tungsteno



SIMS

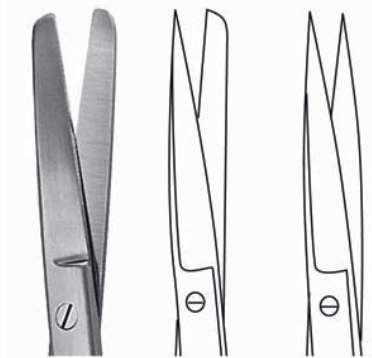

20,0 cm, 8"	75-1254-20-TC	75-1255 -20-TC	75-1256-20-TC
23,0 cm, 9"	75-1254-23-TC	75-1255-23-TC	75-1256-23-TC



SIMS



20,0 cm, 8"	75-1257-20-TC	75-1258-20-TC	75-1259-20-TC
23,0 cm, 9"	75-1257-23-TC	75-1258-23-TC	75-1259-23-TC

Gefäßscheren mit Hartmetallschneiden
 Vascular Scissors with tungsten carbide edges
 Tijeras vasculares con filos de carburo tungsteno
 Forbici vascolari con lame in carburo di tungsteno



DIETHRICH
17,5 cm, 6⁵/₈"
75-1260-17-TC



POTTS DE MARTEL
24,0 cm, 9¹/₂"
75-1261-24-TC



DE BAKEY

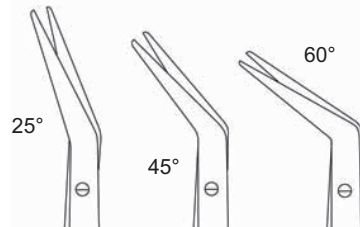

20,0 cm, 8"	75-1262-25-TC	75-1264-45-TC	75-1266-60-TC
23,0 cm, 9"	75-1263-25-TC	75-1265-45-TC	75-1267-60-TC

Gefäßscheren mit Hartmetallschneiden
 Vascular Scissors with tungsten carbide edges
 Tijeras vasculares con filos de carburo tungsteno
 Forbici vascolari con lame in carburo di tungsteno



DIETRICH-HEGEMANN
18,0 cm, 7"

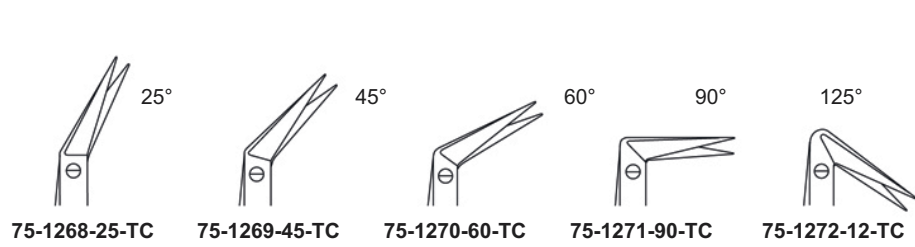

POTTS-SMITH
18,0 cm, 7 1/2"

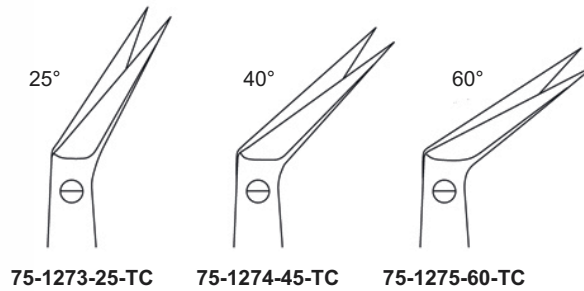

Scheren mit Hartmetallschneiden
Scissors with tungsten carbide edges
Tijeras con filos de carburo tungsteno
Forbici con lame in carburo di tungsteno



IRIS
11,5 cm, 4½"



UNIVERSAL
12,0 cm, 4¾"
75-1279-12-TC

gezahnt
serrated
dentada
dentata



LISTER
18,0 cm, 7"
75-1280-18-TC

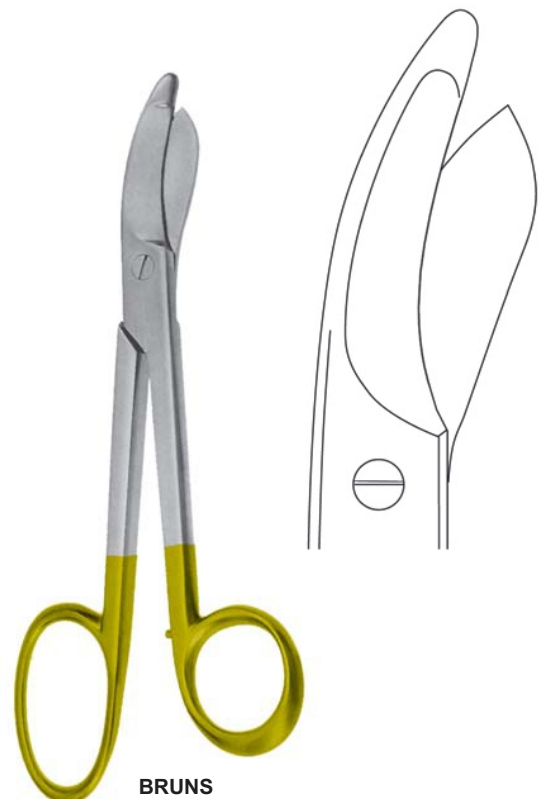

BRUNS
24,0 cm, 9½"
75-1281-24-TC

**Super-Cut Scheren
Super-Cut Scissors
Tijeras Super-Cut
Forbici Super-Cut**



MAYO
17,0 cm, 6³/₄"

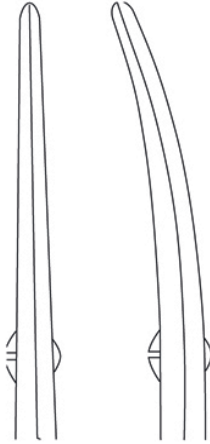

AK-1284-17-SC 75-1285-17-SC



METZENBAUM



14,5 cm, 5³/₄" **75-1282-14-SC**
18,0 cm, 7" **75-1282-18-SC**
20,0 cm, 8" **75-1282-20-SC**
23,0 cm, 9" **75-1282-23-SC**

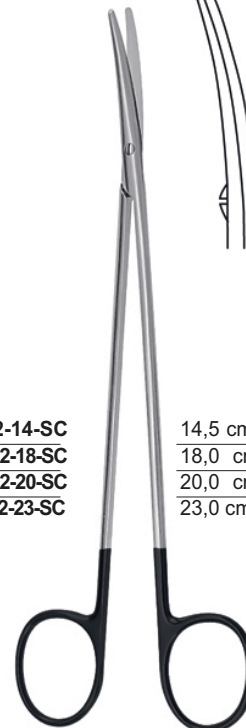

METZENBAUM-FINO



14,5 cm, 5³/₄" **75-1283-14-SC**
18,0 cm, 7" **75-1283-18-SC**
20,0 cm, 8" **75-1283-20-SC**
23,0 cm, 9" **75-1283-23-SC**



KAYE FACE LIFT



15,0 cm, 6" **75-1286-15-SC**
19,0 cm, 7¹/₂" **75-1287-19-SC**



JABALEY
13,0 cm, 5"
75-1288-13-SC







ENDARTERECTOMY
18,0 cm, 7"
75-1289-18-SC



TOENNIS-ADSON
17,0 cm, 6³/₄"
75-1290-17-SC

Super-Cut Scheren
Super-Cut Scissors
Tijeras Super-Cut
Forbici Super-Cut

			
<p>STRABISMUS 11,5 cm, 4½"</p>	<p>JAMISON 15,0 cm, 6" 75-1293-15-SC 18,0 cm, 7" 75-1293-18-SC</p>	<p>REYNOLDS 12,5 cm, 5" 75-1294-12-SC</p>	<p>BABY-METZENBAUM 11,0 cm, 4¾" 75-1295-11-SC 14,5 cm, 5¾" 75-1295-14-SC</p>

			
<p>IRIS 11,0 cm, 4¾" 75-1296-11-SC</p>	<p>IRIS 11,0 cm, 4¾" 75-1297-11-SC</p>	<p>STEVENS TENOTOMY 11,0 cm, 4¾" 75-1298-11-SC</p>	<p>STEVENS TENOTOMY 11,0 cm, 4¾" 75-1299-11-SC</p>

Super-Cut Scheren
Super-Cut Scissors
Tijeras Super-Cut
Forbici Super-Cut



PAR TYPE
12,0 cm, 4³/₄"
75-1303-12-SC



PAR TYPE
12,0 cm, 4³/₄"
75-1304-12-SC



POTTS
19,0 cm, 7¹/₂"



75-1300-25-SC

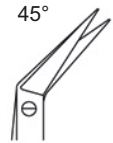

75-1301-45-SC

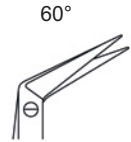

75-1302-60-SC



FOMON
14,5 cm, 5³/₄"
75-1305-15-SC

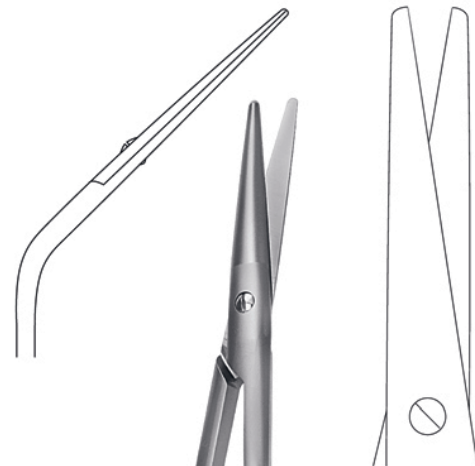

COTTLE
16,5 cm, 6¹/₂"
75-1306-16-SC

**Mikro-Scheren
Micro Scissors
Micro-Tijeras
Micro-Forbici**

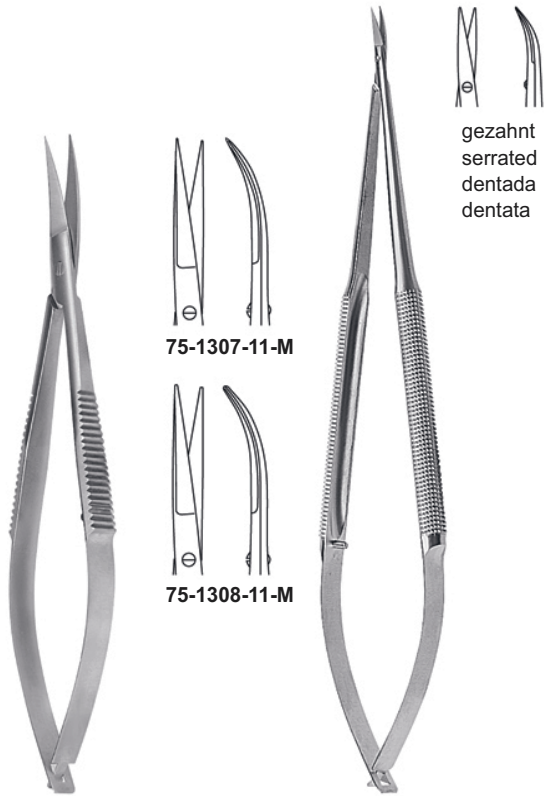

gezahnt
serrated
dentada
dentata

75-1307-11-M

75-1308-11-M

WESTCOTT
11,0 cm, 4³/₈"

GOMEL
14,0 cm, 5¹/₂" **75-1312-14-M**
16,0 cm, 6¹/₄" **75-1312-16-M**



Mikro-Präparierscheren
Micro-dissecting scissors
Micro-tijeras de disección
Micro-forbici per dissezione

HEPP SCHEIDEL
14,0 cm, 5¹/₂" **75-1313-14-M**
16,0 cm, 6¹/₄" **75-1313-16-M**

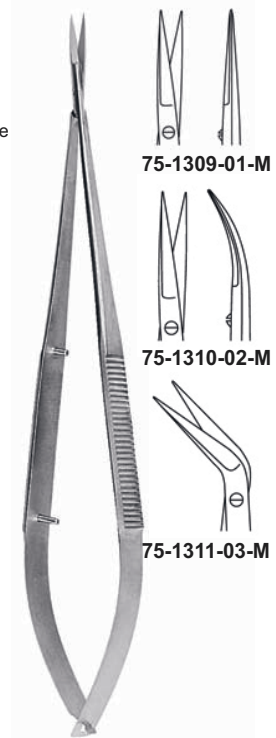

75-1309-01-M

75-1310-02-M

75-1311-03-M

18,5 cm, 7¹/₄"



SIMS



18,5 cm, 7¹/₄" **AK-1314-01** **AK-1315-02** **AK-1316-03** **AK-1318-04**
22,5 cm, 8³/₄" **75-1319-01** **75-1320-02** **75-1321-03** **75-1322-04**



18,5 cm, 7¹/₄" **AK-1323-01-M** **AK-1325-02-M**
22,5 cm, 8³/₄" **AK-1324-01-M** **AK-1326-02-M**

Mikro-Scheren, Mikro-Disektionsscheren
Micro Scissors, Micro Dissecting Scissors
Micro-Tijeras, Micro-Tijeras de disección
Micro-Forbici, Micro-Forbici per dissezione



18,0 cm, 7"



75-1327-25-M



75-1328-45-M

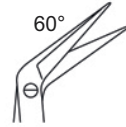

75-1329-60-M

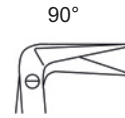

75-1330-90-M



75-1331-12-M



75-1332-25-M



75-1333-45-M

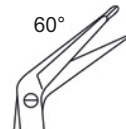

75-1334-60-M

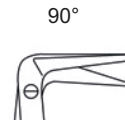

75-1335-90-M



75-1336-12-M



15,0 cm, 6"
75-1337-15-M



15,0 cm, 6"
75-1338-15-M



gezahnt
serrated
dentada
dentata



15,0 cm, 6"
75-1339-15-M



18,0 cm, 7"
75-1340-18-M

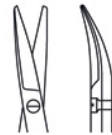

Mikro-Adventitiascheren
Micro Adventitia Scissors
Micro-Tijeras Adventitia
Micro-Forbici Adventitia



15,0 cm, 6"
75-1341-15 -M



15,0 cm, 6"
75-1342-15 -M



gezahnt
serrated
dentada
dentata



15,0 cm, 6"
75-1343-15 -M



18,0 cm, 7"
75-1344-18-M

