



C10
221 to 230



**Galle, Leber, Niere, Blase, Urologie
Gall, Liver, Kidney, Bladder, Urology
Bilis, Hígado, Riñon, Vejiga, Urología
Bile, Fegato, Rene, Vescica, Urologia**

Nierensteinzangen, Gallensteinzangen
Kidney Stone Forceps, Gall Stone Forceps
Pinzas para los cálculos renales, Pinzas para los cálculos biliares
Pinze per calcoli renali, Pinze per calcoli biliari



RANDALL



23,0 cm, 9"
75-2164-01

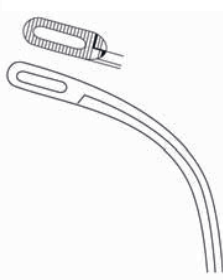

22,0 cm, 8⁵/₈"
75-2164-02

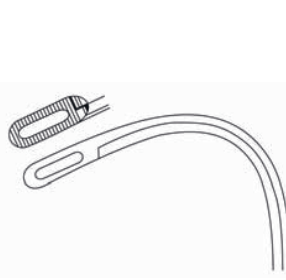

22,0 cm, 8⁵/₈"
75-2164-03



22,0 cm, 8⁵/₈"
75-2164-04



19,0 cm, 7¹/₂"
75-2164-05

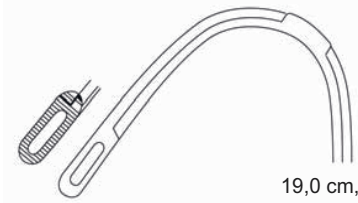

19,0 cm, 7¹/₂"
75-2164-06



DESJARDINS
23,0 cm, 9"



75-2165-01



75-2165-02



MIXTER
22,0 cm, 8⁵/₈"
75-2166-22



MAYO BLAKE
20,0 cm, 8"
75-2168-20



20,0 cm, 8"
75-2169-20

Gallensteinzangen
Gall Stone Forceps
Pinzas para los cálculos biliares
Pinze per calcoli biliari

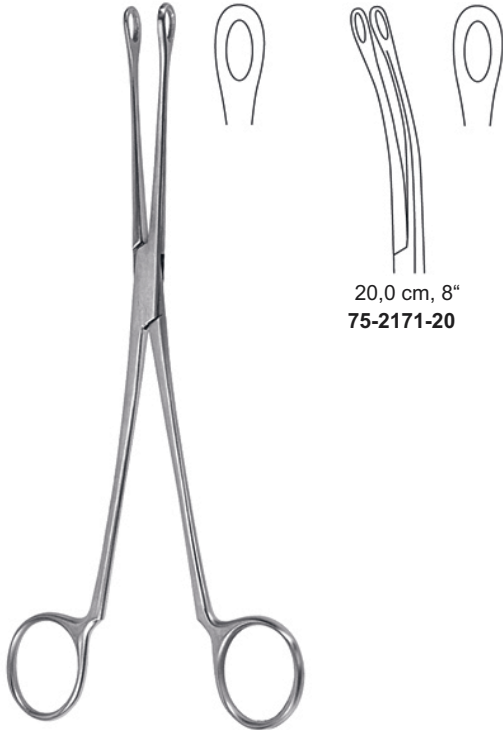

BLAKE
20,0 cm, 8"
75-2170-20

20,0 cm, 8"
75-2171-20

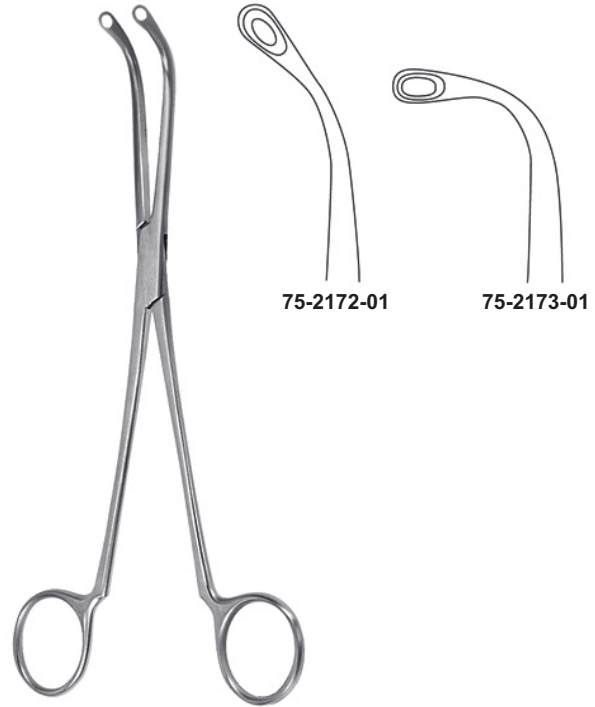

TURNER-WARWICK
18,0 cm, 7"

75-2172-01

75-2173-01

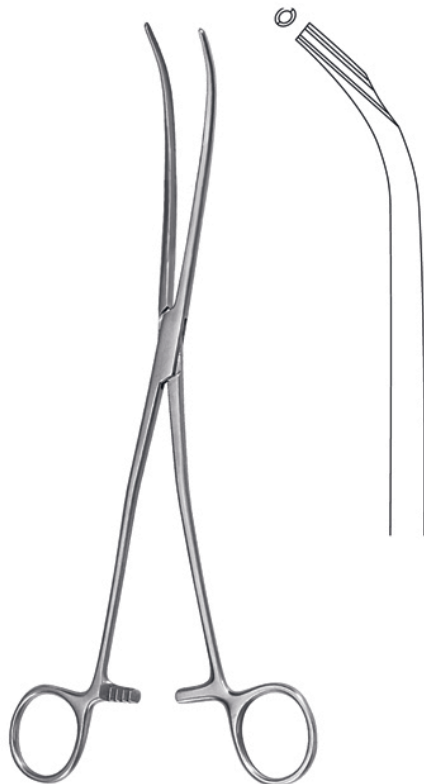

SÖKELAND
24,0 cm, 9½"
75-2174-24



CZERNY
24,5 cm, 9⅝"
75-2175-24

Gallensteinlöffel
Gall Stone Scoops
Cucharillas para los cálculos biliares
Cucchiai per calcoli biliari



LUER-KÖRTE
 24,0 cm, 9 1/2"

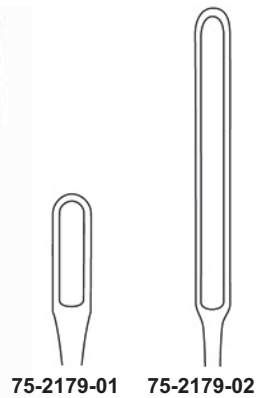
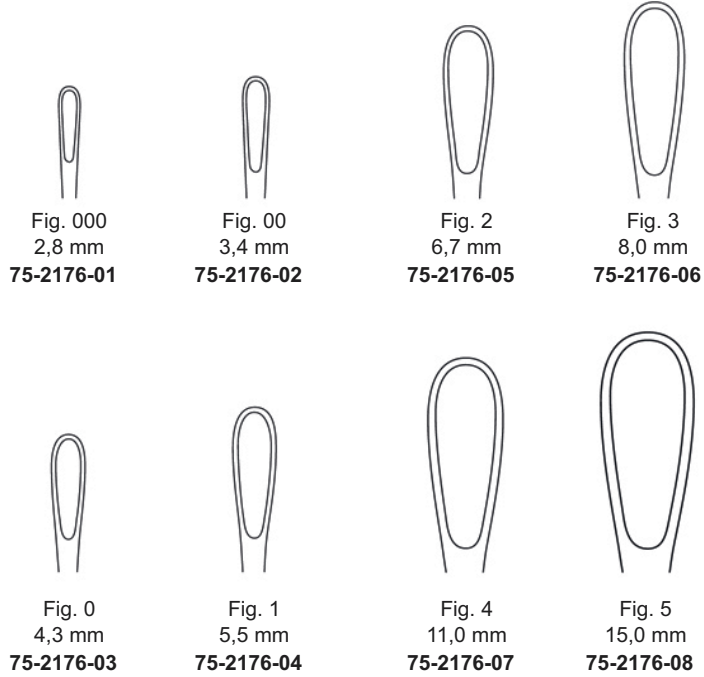

Gallengangsonden, Gallengang Dilatoren
Gall Duct Probes, Common Bile Duct Dilators
Sonas p. el conducto biliar, Dilatadores para el conducto biliar
Dilatatori per condotti biliari, Dilatatori per coledoco



MAYO
32,0 cm, 12¹/₂"
75-2181-32



OCHSNER
35,0 cm, 13³/₄"
75-2182-35



DESJARDINS
28,0 cm, 11"

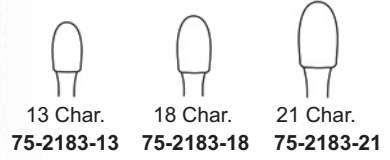

MOORE
30,0 cm, 12"
75-2185-30

Gallenblasenlöffel
Gall bladder scoope
Cuccharilla para la vesicula biliar
Cucchiaio per colecisti



DESJARDINS
28,0 cm, 11"



Gallengang Dilatoren
Common Bile Duct Dilators
Dilatadores para el conducto biliar
Dilatatori per coledoco

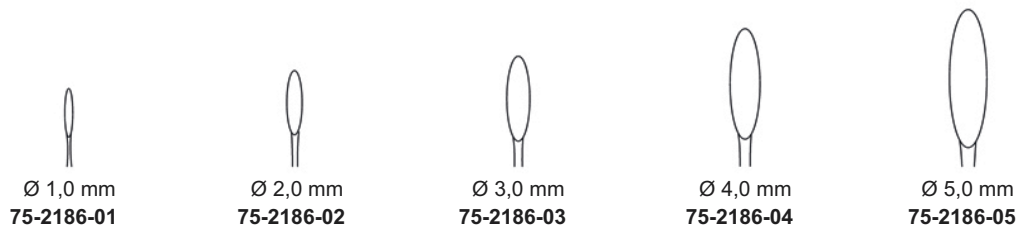

BAKES
30,0 cm, 11³/₄"
75-2186-30

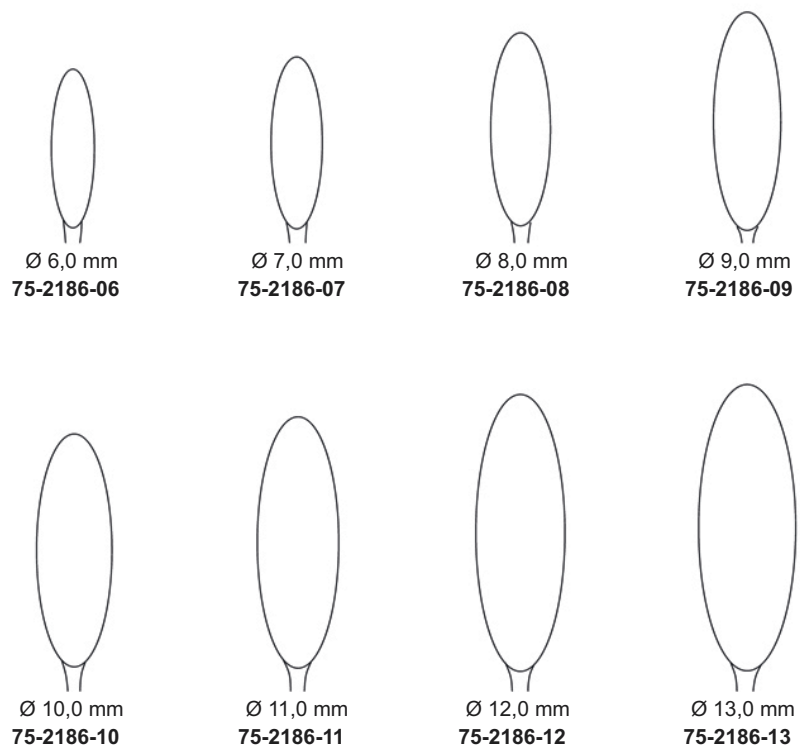



Blasenwundspreizer
Bladder Retractors
Deaparadores para la vejiga
Divaricatori vescicali

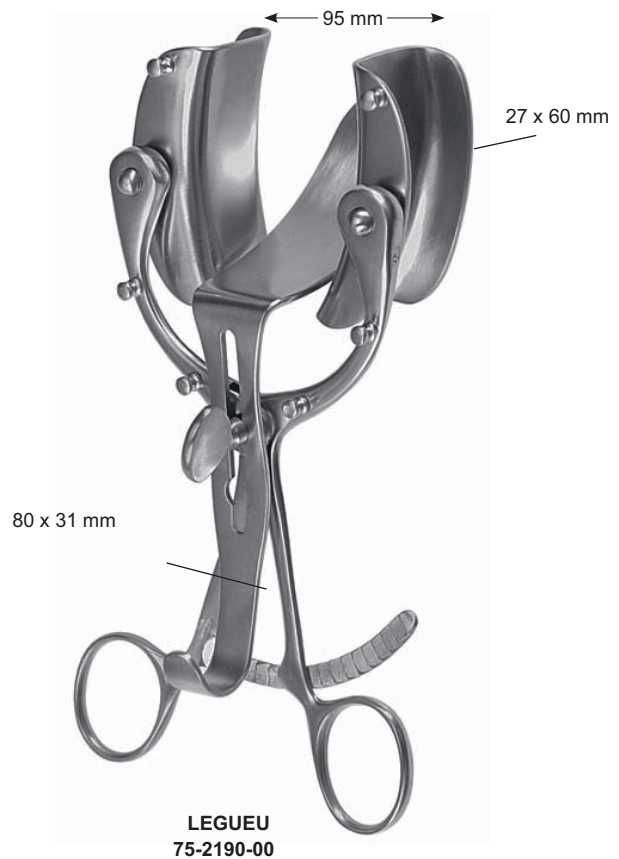

Instrumente für Prostektomie
 Prostatectomy Instruments
 Instrumentos para la prostatectomía
 Strumenti per operazioni della prostata



MILLIN
 23,0 cm, 9"
 75-2191-23



MILLIN
 24,0 cm, 9½"
 75-2192-24



MILLIN
 24,0 cm, 9½"
 75-2193-24



MILLIN
 23,0 cm, 9"
 75-2195-23



MILLIN
 28,5 cm, 11¼"
 75-2196-24



20,0 cm, 8" **75-2197-20**
 28,0 cm, 11" **75-2197-28**

MATHIEU

Prostatahaken, Blasenspatel
Prostatic Retractors, Bladder Retractor
Separadores para la prostata, Separadores vesicales
Retrattori prostatici, Divaricatori vescicali



YOUNG
21,0 cm, 8¹/₄"
75-2198-21



YOUNG
22,0 cm, 8⁵/₈"
75-2199-22



YOUNG
21,0 cm, 8¹/₄"
75-2200-21

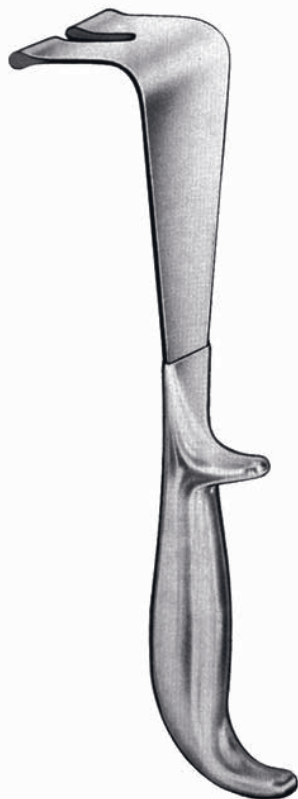

YOUNG
22,0 cm, 8⁵/₈"
75-2201-22



LEGUEU
26,0 cm, 10¹/₄"
75-2202-26



KOCHER
23,5 cm, 9¹/₄"
75-2203-23

Katheter, Penisklemmen
Catheters, Penis Clamp
Sondas, Compresor urétral
Cateteri, Serrapene



für Männer
for men
para hombres
per uomini

Char. 8	75-2204-08
Char. 10	75-2204-10
Char. 12	75-2204-12
Char. 14	75-2204-14
Char. 16	75-2204-16
Char. 18	75-2204-18
Char. 20	75-2204-20
Char. 22	75-2204-22
Char. 24	75-2204-24

29,0 cm, 11½"



für Frauen
for women
para mujeres
per donne

Char. 6	75-2205-06
Char. 7	75-2205-07
Char. 8	75-2205-08
Char. 9	75-2205-09
Char. 10	75-2205-10
Char. 11	75-2205-11
Char. 12	75-2205-12
Char. 13	75-2205-13
Char. 14	75-2205-14
Char. 15	75-2205-15
Char. 16	75-2205-16
Char. 18	75-2205-18
Char. 20	75-2205-20
Char. 24	75-2205-24

16,0 cm, 6¼"



STRAUSS
11,0 cm, 4⅓"
75-2207-11



STOCKMANN
8,0 cm, 3¼"
75-2208-08

Ø 8,0 mm	75-2206-08
Ø 11,0 mm	75-2206-11
Ø 13,0 mm	75-2206-13
Ø 16,0 mm	75-2206-16
Ø 21,0 mm	75-2206-21
Ø 26,0 mm	75-2206-26
Ø 32,0 mm	75-2206-32

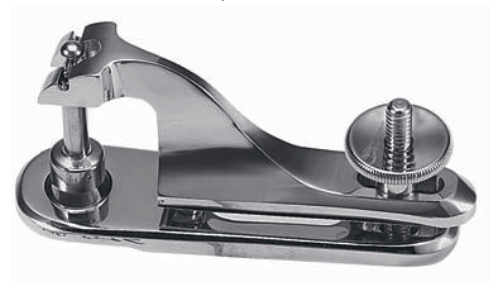

COMCO