



Gynäkologie, Gebusthilfe

Gynecology, Obstetrics

Ginecología, Obstetricia

Ginecologia, Ostetricia

Scheidenspekula
Vaginal Specula
Espéculos vaginales
Speculi vaginali

für Kinder
for children
para niños
per bambini



COLLIN
65 x 10 mm
75-2285-00

für Jungfrauen
for virgins
para vírgenes
per vergini



COLLIN
65 x 10 mm
75-2286-00

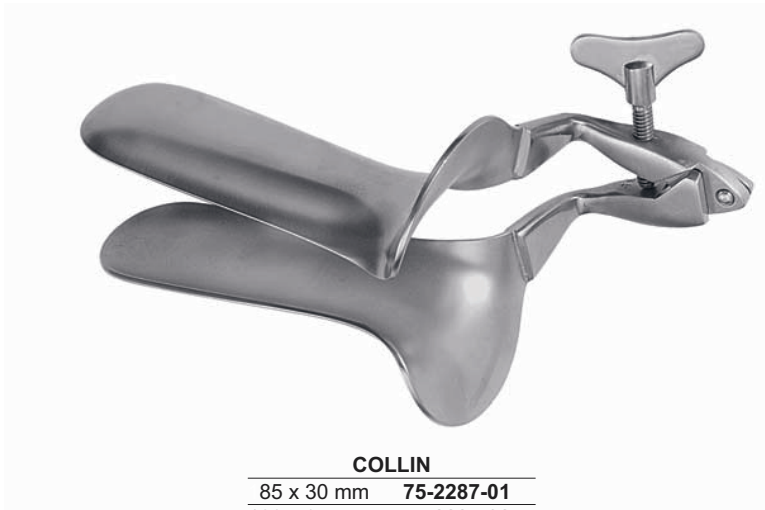

COLLIN

85 x 30 mm	75-2287-01
100 x 35 mm	75-2287-02
110 x 40 mm	75-2287-03



CUSCO

80 x 24 mm	75-2288-01
80 x 32 mm	75-2288-02
98 x 16 mm	75-2288-03
105 x 25 mm	75-2288-04
107 x 29 mm	75-2288-05
115 x 35 mm	75-2288-06

Scheidenspekula
Vaginal Specula
Espécucos vaginales
Speculi vaginali



zentrale Stellschraube
central fixation screw
tornillo de sujeto central
vite di regolazione centrale

CUSCO

75 x 32 mm	75-2289-01
85 x 36 mm	75-2289-02
95 x 37 mm	75-2289-03



seitliche Stellschraube
lateral fixation screw
tornillo de sujeto lateral
vite di regolazione laterale

für Jungfrauen
for virgins
para virgenes
per vergini

CUSCO

75 x 17 mm	75-2290-00
------------	-------------------



seitliche Stellschraube
lateral fixation screw
tornillo de sujeto lateral
vite di regolazione laterale

CUSCO

75 x 32 mm	75-2291-01
85 x 35 mm	75-2291-02
100 x 35 mm	75-2291-03



Schweizer Modell
Swiss pattern
Modelo suizo
Modello svizzero

CUSCO

90 x 23-25 mm	75-2292-01
100 x 25-27 mm	75-2292-02
110 x 27-30 mm	75-2292-03

Scheidenspekula
Vaginal Specula
Espéculos vaginales
Speculi vaginali



GRAVE

75 x 20 mm	75-2293-01
95 x 35 mm	75-2293-02
115 x 35 mm	75-2293-03



PEDERSON

75 x 13 mm	75-2294-01
100 x 22 mm	AK-2294-02
120 x 25 mm	75-2294-03



SEMM

90 x 14-18 mm	75-2295-01
100 x 17-20 mm	75-2295-02
100 x 25-30 mm	75-2295-03



WEISSBARTH
21,0 cm, 8 1/4"
75-2296-00

Scheidenspekula
Vaginal Specula
Espéculos vaginales
Speculi vaginali



1,14 kg

AUVARD
75 x 38 mm
75-2297-00



1,14 kg

AUVARD
75 x 38 mm
75-2298-00

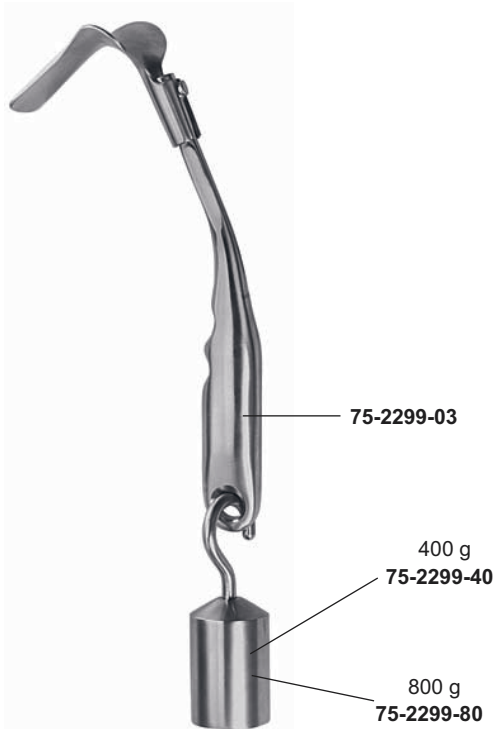

SCHERBACK
75-2299-00

koplett, complete, completo, completo

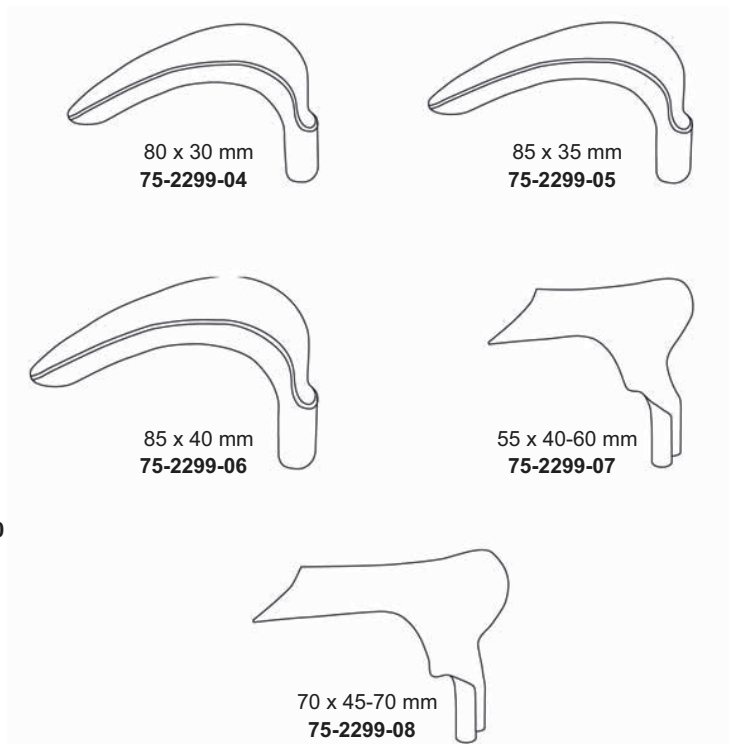

Scheidenspekula
Vaginal Specula
Espéculos vaginales
Speculi vaginali



Satz
Set
Juego
Set

KRISTELLER
Fig. 1 **75-2300-01**
Fig. 2 **75-2300-02**
Fig. 3 **75-2300-03**



Spekula allein, fl ach
Specula only, fl at hollow
Espéculos suelto, con huecos planos
Solo speculi, piatta

KRISTELLER
105 x 26 mm **75-2301-01**
105 x 28 mm **75-2301-02**
105 x 33 mm **75-2301-03**

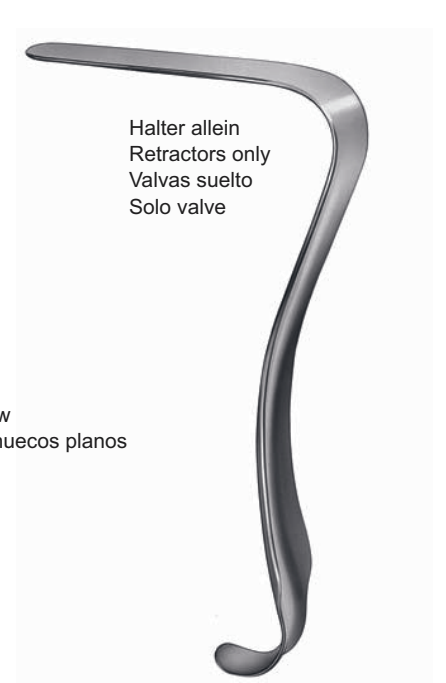

Halter allein
Retractors only
Valvas suelto
Solo valve

KRISTELLER
115 x 22 mm **75-2302-01**
115 x 24 mm **75-2302-02**
115 x 29 mm **75-2302-03**



Satz
Set
Juego
Set

KRISTELLER
Fig. 1 **75-2303-01**
Fig. 2 **75-2303-02**
Fig. 3 **75-2303-03**

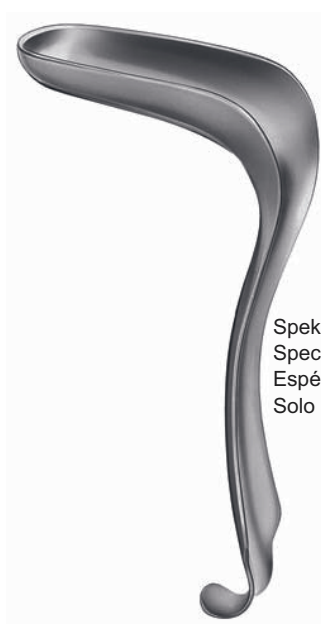

Spekula allein, fl ach
Specula only, fl at hollow
Espéculos suelto, con huecos planos
Solo speculi, piatta

KRISTELLER
110 x 27 mm **75-2304-01**
110 x 30 mm **75-2304-02**
110 x 36 mm **75-2304-03**

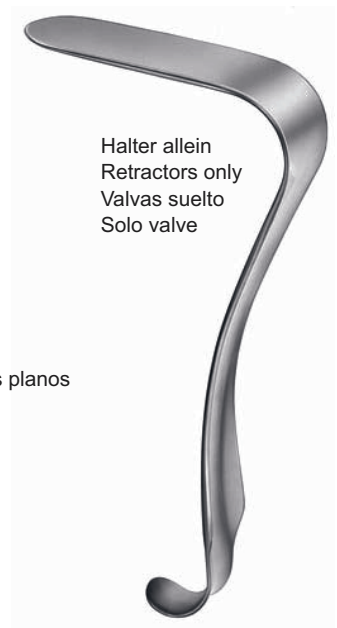

Halter allein
Retractors only
Valvas suelto
Solo valve

KRISTELLER
115 x 23 mm **75-2305-01**
115 x 26 mm **75-2305-02**
115 x 32 mm **75-2305-03**

Scheidenspekula
Vaginal Specula
Especulos vaginales
Speculi vaginali

Satz
Set
Juego
Set



Spekula allein
Specula only
Especulos suelto
Solo speculi

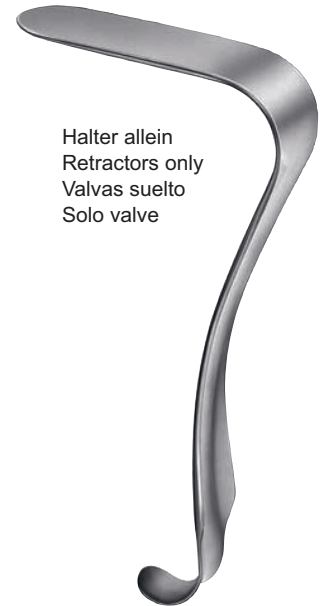

Halter allein
Retractors only
Valvas suelto
Solo valve

KRISTELLER

Fig. 0 **75-2306-00**
Fig. 1 **75-2306-01**
Fig. 2 **75-2306-02**
Fig. 3 **75-2306-03**

KRISTELLER

70 x 15 mm **75-2307-00**
70 x 27 mm **75-2307-01**
80 x 30 mm **75-2307-02**
90 x 36 mm **75-2307-03**

KRISTELLER

75 x 10 mm **75-2308-00**
75 x 23 mm **75-2308-01**
85 x 26 mm **75-2308-02**
100 x 32 mm **75-2308-03**

konisch, für Jungfrauen
conical blades, for virgins
valvos cónicos, para vírgenes
valve coniche, per vergini



Satz
Set
Juego
Set



Spekula allein
Specula only
Especulos suelto
Solo speculi



Halter allein
Retractors only
Valvas suelto
Solo valve

KRISTELLER

Fig. 00 **75-2309-01**
Fig. 0 **75-2309-02**

KRISTELLER

105 x 18 mm **75-2310-01**
105 x 21 mm **75-2310-02**

KRISTELLER

110 x 14 mm **75-2311-01**
110 x 17 mm **75-2311-02**

Scheidenspekula
Vaginal Specula
Especulos vaginales
Speculi vaginali

leicht hohl
slightly-concave
ligeremente concavos
leggeremente concavi

Fig	a x b	
1	55 x 35 mm	75-2312-01
2	85 x 35 mm	75-2312-02
3	115 x 35 mm	75-2312-03
1	55 x 45 mm	75-2313-01
2	85 x 45 mm	75-2313-02
3	115 x 45 mm	75-2313-03
4	160 x 45 mm	75-2313-04
1	55 x 60 mm	75-2314-01
2	85 x 60 mm	75-2314-02
3	115 x 60 mm	75-2314-03
4	160 x 60 mm	75-2314-04

DOYEN
23,0 cm, 9"

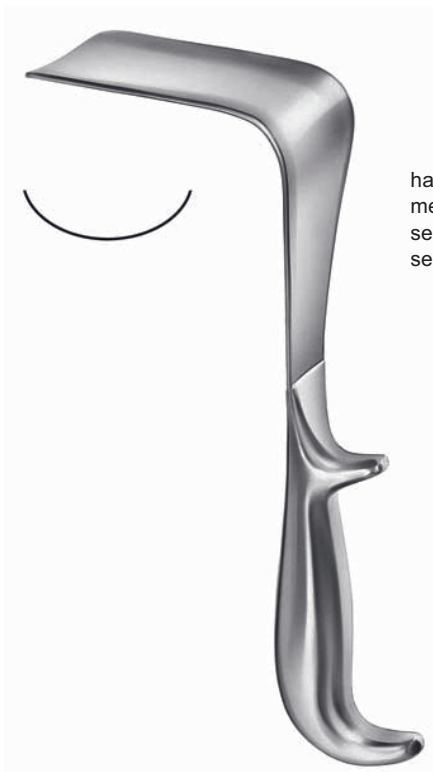

halb-hohl
medium-concave
semi-concavos
semi-concavi

Fig	a x b	
1	55 x 35 mm	75-2315-01
2	85 x 35 mm	75-2315-02
3	115 x 35 mm	75-2315-03
1	55 x 45 mm	75-2316-01
2	85 x 45 mm	75-2316-02
3	115 x 45 mm	75-2316-03
1	55 x 60 mm	75-2317-01
2	85 x 60 mm	75-2317-02
3	115 x 60 mm	75-2317-03

DOYEN
23,0 cm, 9"

Scheidenspekula
Vaginal Specula
Espéculos vaginales
Speculi vaginali

Satz
Set
Juego
Set



Spekula allein
Specula only
Espéculos suelto
Solo speculi

Halter allein
Retractors only
Valvas suelto
Solo valve

KALLMORGEN	
70 x 40 mm	75-2318-01
90 x 40 mm	75-2318-02

KALLMORGEN	
70 x 40 mm	75-2319-01
90 x 40 mm	75-2319-02

KALLMORGEN	
70 x 40 mm	75-2320-01
90 x 40 mm	75-2320-02



70 x 15 mm

KRISTELLER
17,0 cm, 6³/₄"
75-2321-17

75 x 39 mm

KALLMORGEN
17,0 cm, 6³/₄"
75-2322-17



JACKSON	
75 x 38 mm	75-2323-01
90 x 38 mm	75-2323-02
100 x 38 mm	75-2323-03

Scheidenspekula
Vaginal Specula
Espéculos vaginales
Speculi vaginali

76 x 25 mm



70 x 22 mm

BREISKY
14,0 cm, 5½"
75-2324-01

82 x 30 mm

76 x 25 mm

BREISKY
14,0 cm, 5½"
75-2324-02

95 x 38 mm

102 x 44 mm



82 x 30 mm

95 x 38 mm

BREISKY
17,0 cm, 6¾"
75-2325-03

BREISKY
17,0 cm, 6¾"
75-2325-04

Scheidenspekula und -halter
Vaginal Specula and Retractors
Espéculos y valvas vaginales
Speculi e valve vaginali

SIMS
GO-1294-00
Satz, Set, Juego, Set



70 x 30 mm

65 x 25 mm

SIMS
12,5 cm, 5"
75-2325-01

70 x 35 mm

70 x 30 mm

SIMS
15,0 cm, 6"
75-2325-02

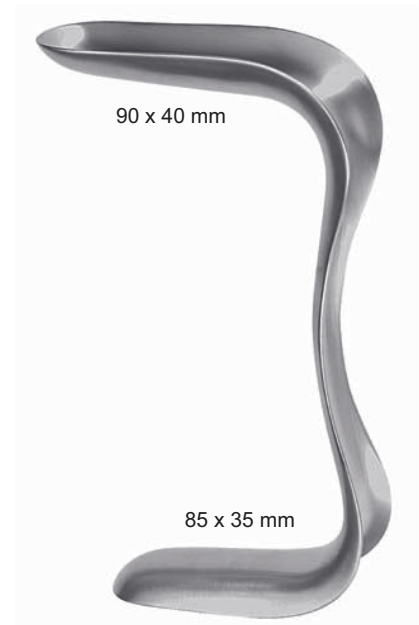

90 x 40 mm

85 x 35 mm

SIMS
17,5 cm, 7"
75-2325-03

Spekula allein
Specula only
Espéculos suelto
Solo speculi

Halter allein
Retractors only
Valvas suelto
Solo valve



MATHIEU
100 x 13-23 mm **75-2326-01**
100 x 16-30 mm **75-2326-02**

MATHIEU
100 x 11-21 mm **75-2327-01**
100 x 14-27 mm **75-2327-02**

LANDAU
100 x 28 mm **75-2328-01**
100 x 38 mm **75-2328-02**

**Scheidenspekula
Vaginal Specula
Espéculos vaginales
Speculi vaginali**



100 x 20 mm	75-2329-20
100 x 25 mm	75-2329-25
100 x 30 mm	75-2329-30
100 x 35 mm	75-2329-35
100 x 40 mm	75-2329-40
<hr/>	
130 x 20 mm	75-2330-20
130 x 25 mm	75-2330-25
130 x 30 mm	75-2330-30
130 x 35 mm	75-2330-35
130 x 40 mm	75-2330-40
<hr/>	
155 x 40 mm	75-2330-40

BREISKY



90 x 20 mm	75-2331-20
<hr/>	
100 x 10 mm	75-2331-10
100 x 20 mm	75-2331-20
100 x 25 mm	75-2331-25
<hr/>	
125 x 15 mm	75-2332-15
125 x 20 mm	75-2332-20
125 x 25 mm	75-2332-25
125 x 30 mm	75-2332-30
125 x 35 mm	75-2332-35
125 x 40 mm	75-2332-40

MATZENAUER



85 x 17 mm

BRAUN, MODIF.
19,0 cm, 7 1/2"
75-2333-19



60 x 30 mm

DOYEN
23,0 cm, 9"
75-2333-23



80 x 30 mm

DOYEN
25,0 cm, 9"
75-2333-25



95 x 38 mm

WERTHEIM
30,0 cm, 12"
75-2333-30

Endospekula, Lateral-Spekulum, Intrauterinsonde
Endospecula, Lateral Speculum, Intrauterine Probe
Endoespécucos, Espéculo lateral, Sonda intra-uterina
Endospeculi, Speculo lateral, Sonde intrauterine

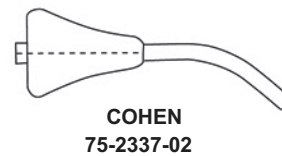
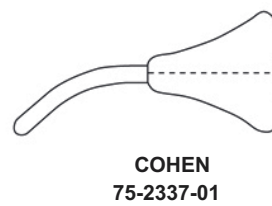
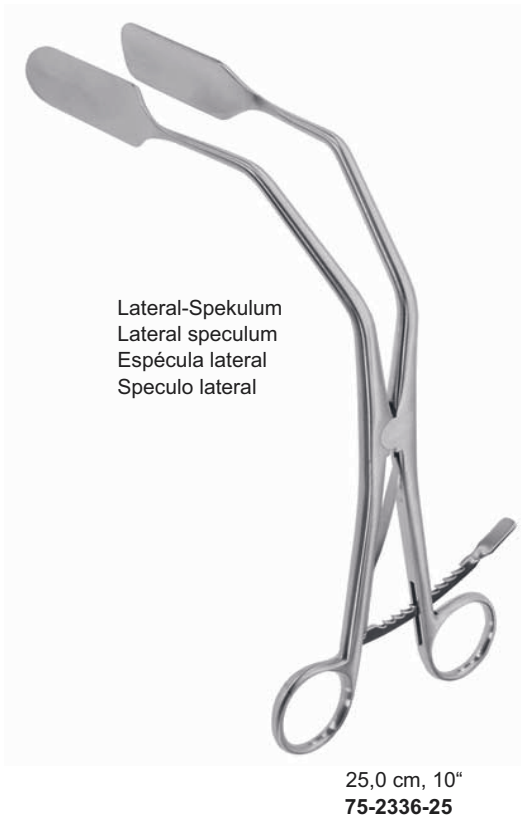
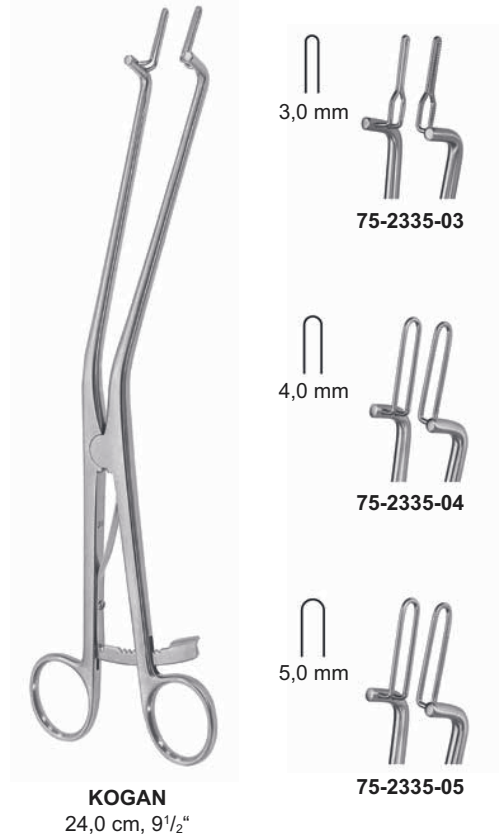

**Uterus-Dilatatoren
Uterine Dilators
Dilatadores uterinos
Dilatatori uterini**



HEGAR
18,5 cm, 7 1/4"

Ø 1,0 mm	75-2338-01
Ø 2,0 mm	75-2338-02
Ø 3,0 mm	75-2338-03
Ø 4,0 mm	75-2338-04
Ø 5,0 mm	75-2338-05
Ø 6,0 mm	75-2338-06
Ø 7,0 mm	75-2338-07
Ø 8,0 mm	75-2338-08
Ø 9,0 mm	75-2338-09
Ø 10,0 mm	75-2338-10
Ø 11,0 mm	75-2338-11
Ø 12,0 mm	75-2338-12
Ø 13,0 mm	75-2338-13
Ø 14,0 mm	75-2338-14
Ø 15,0 mm	75-2338-15
Ø 16,0 mm	75-2338-16
Ø 17,0 mm	75-2338-17
Ø 18,0 mm	75-2338-18
Ø 19,0 mm	75-2338-19
Ø 20,0 mm	75-2338-20
Ø 21,0 mm	75-2338-21
Ø 22,0 mm	75-2338-22
Ø 23,0 mm	75-2338-23
Ø 24,0 mm	75-2338-24
Ø 25,0 mm	75-2338-25
Ø 26,0 mm	75-2338-26



HEGAR
18,5 cm, 7 1/4"

Ø 1,5 mm	75-2339-01
Ø 2,5 mm	75-2339-02
Ø 3,5 mm	75-2339-03
Ø 4,5 mm	75-2339-04
Ø 5,5 mm	75-2339-05
Ø 6,5 mm	75-2339-06
Ø 7,5 mm	75-2339-07
Ø 8,5 mm	75-2339-08
Ø 9,5 mm	75-2339-09
Ø 10,5 mm	75-2339-10
Ø 11,5 mm	75-2339-11
Ø 12,5 mm	75-2339-12
Ø 13,5 mm	75-2339-13
Ø 14,5 mm	75-2339-14
Ø 15,5 mm	75-2339-15
Ø 16,5 mm	75-2339-16
Ø 17,5 mm	75-2339-17



205 x 105 x 45 mm

HEGAR
75-2340-99
Satz, Set, Juego, Set
Ø 1,0 - Ø 26,0
(26 dilators)

HEGAR
75-2340-98
Satz, Set, Juego, Set
Ø 4,0 - Ø 17,0
(14 dilators)

Uterus-Dilatatoren
Uterine Dilators
Dilatadores uterinos
Dilatatori uterini



HEGAR
20,0 cm, 8"

1,0 / 2,0 mm	75-2341-01
Ø 3,0 / 4,0 mm	75-2341-03
Ø 5,0 / 6,0 mm	75-2341-05
Ø 7,0 / 8,0 mm	75-2341-07
Ø 9,0 / 10,0 mm	75-2341-09
Ø 11,0 / 12,0 mm	75-2341-11
Ø 13,0 / 14,0 mm	75-2341-13
Ø 15,0 / 16,0 mm	75-2341-15
Ø 17,0 / 18,0 mm	75-2341-17
Ø 19,0 / 20,0 mm	75-2341-19
Ø 21,0 / 22,0 mm	75-2341-21
Ø 23,0 / 24,0 mm	75-2341-23
Ø 25,0 / 26,0 mm	75-2341-25



HEGAR
75-2342-98
Satz, Set, Juego, Set
Ø 3,0 / 4,0 - Ø 17,0 / 18,0 mm
(8 dilators)

HEGAR
75-2342-99
Satz, Set, Juego, Set
Ø 1,0 / 2,0 - Ø 25,0 / 26,0 mm
(13 dilators)



HANK

Ø 4,5 / 5,0 mm	75-2344-05
Ø 5,5 / 6,0 mm	75-2344-06
Ø 6,5 / 7,0 mm	75-2344-07
Ø 7,5 / 8,0 mm	75-2344-08
Ø 8,5 / 9,0 mm	75-2344-09
Ø 9,5 / 10,0 mm	75-2344-10



HANK
75-1345-98
Satz, Set, Juego, Set
Ø 4,5 / 5,0 - Ø 9,5 / 10,0 mm
(6 dilators)

Uterus-Dilatatoren, Hakenzangen
 Uterine Dilators, Uterine Tenaculum Forceps
 Dilatadores uterinos, Pinzas para coger el cuello del útero
 Dilatatori uterini, Pinze per abbassare il collo dell'utero



PRATT

Ø 4,5 / 5,0 mm	75-2346-05
Ø 5,5 / 6,0 mm	75-2346-06
Ø 7,5 / 8,0 mm	75-2346-08
Ø 8,5 / 9,0 mm	75-2346-09
Ø 9,5 / 10,0 mm	75-2346-10
Ø 11,5 / 12,0 mm	75-2346-12
Ø 12,5 / 13,0 mm	75-2346-13
Ø 13,5 / 14,0 mm	75-2346-14



PRATT

75-2347-98

Satz, Set, Juego, Set
 Ø 4,5 / 5,0 - Ø 13,5 / 14,0 mm
 (8 dilators)



BARRETT
 18,0 cm, 7"
75-2348-18

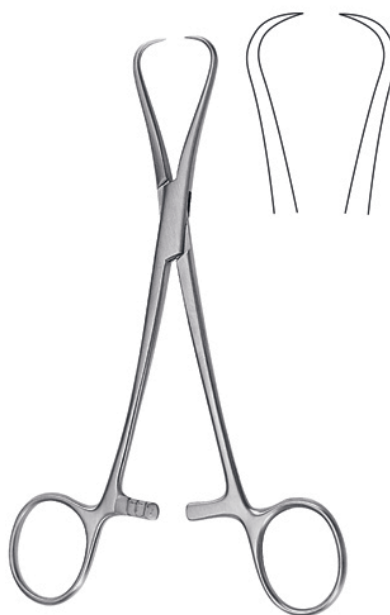

ADAIR
 19,0 cm, 7½"
75-2349-19



STAUDE-MOORE
 17,0 cm, 6¾"
75-2350-17

Hakenzangen
Uterine Tenaculum Forceps
Pinzas para coger el cuello del útero
Pinze per abbassare il collo dell'utero

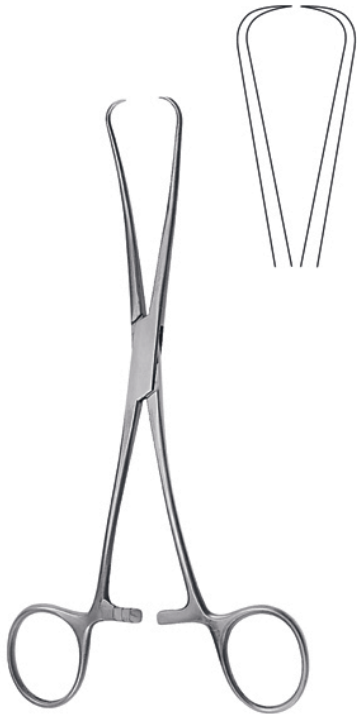

JARCHO
20,0 cm, 8"
75-2351-20



SCHROEDER
25,0 cm, 9³/₄"
75-2352-25



BRAUN
25,0 cm, 9³/₄"
75-2353-25



DUPLAY
28,0 cm, 11"
75-2354-28



POZZI
26,0 cm, 10¹/₄"
75-2355-26



KAHN
24,0 cm, 9¹/₂"
75-2356-24

Hakenzangen
Uterine Tenaculum Forceps
Pinzas para coger el cuello del útero
Pinze per abbassare il collo dell'utero



SKENE
24,0 cm, 9½"
75-2357-24



SCHROEDER
24,0 cm, 9½"
75-2358-24



SCHROEDER
24,0 cm, 9½"
75-2359-24



TEALE
23,0 cm, 9"
75-2360-23



JACOBS
21,0 cm, 8½"
75-2361-21



JACOBS
21,0 cm, 8½"
75-2362-21

Hakenzangen
Uterine Tenaculum Forceps
Pinzas para coger el cuello del útero
Pinze per abbassare il collo dell'utero

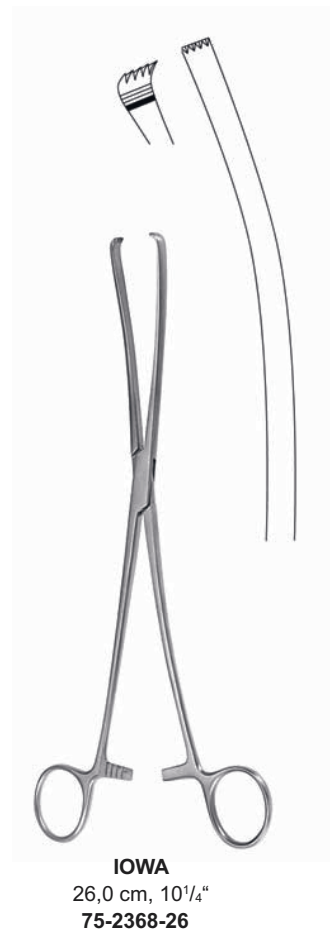
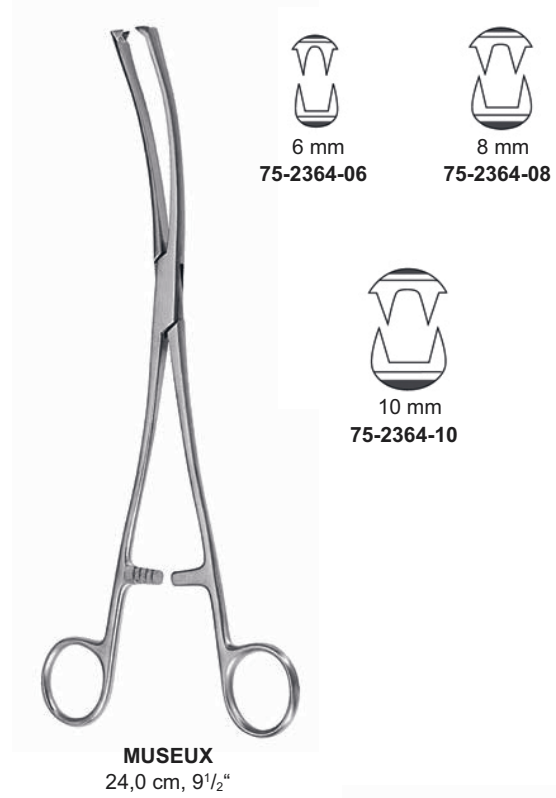
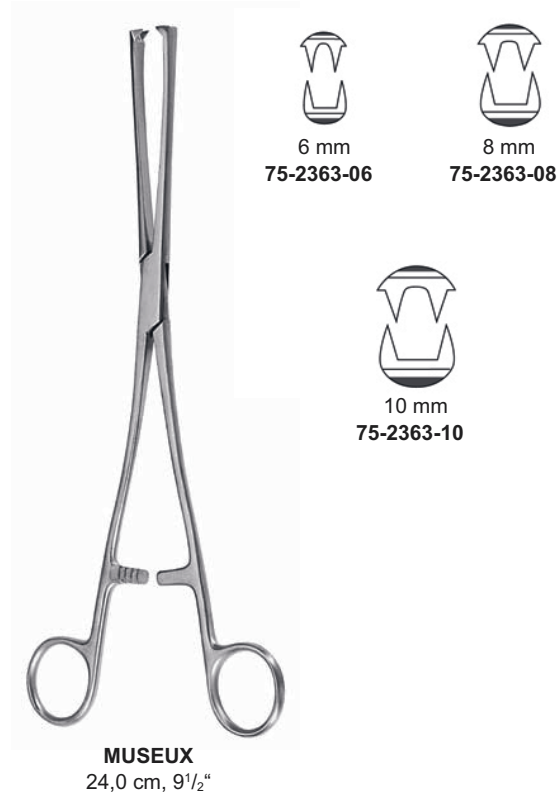

Polypen- und Ovarienzangen, Uterusfaßzangen
 Polypus and Ovum Forceps, Uterine Elevating Forceps
 Pinzas para pólipos uterinos y ovarios, Pinzas para la útero
 Pinze per polipi e ovaie, Pinze per affarrare l'utero



DOYEN
20,5 cm, 8"
75-2369-20

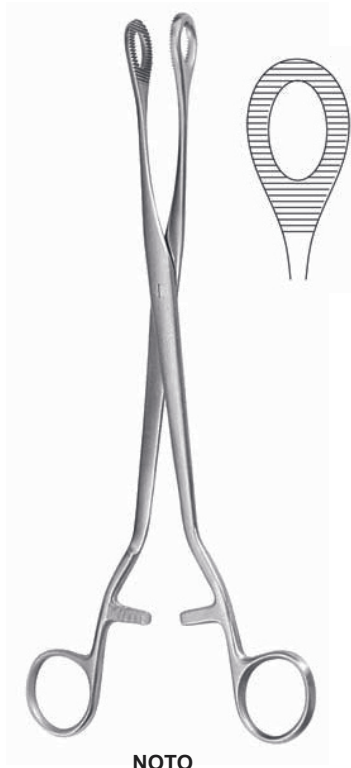

NOTO
27,0 cm, 10⁵/₈"
75-2370-27

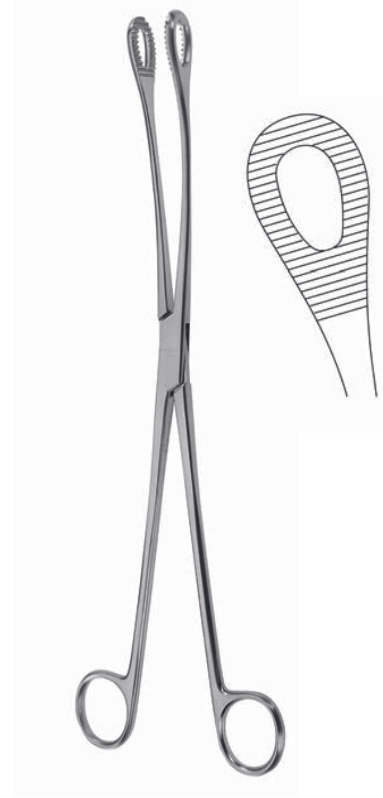

KELLY
32,0 cm, 12¹/₂"
75-2371-32



HEYWOOD-SMITH
25,0 cm, 9³/₄"
75-2372-25



DARTIGUES
27,0 cm, 10³/₄"
75-2373-27



SOMER
23,0 cm, 9"
75-2374-23

Uterusfaßzangen, Uterussonden, Zentimetereinteilung
 Uterine Elevating Forceps, Uterine Probes, graduated in centimeters
 Pinzas para la útero, Histerómetros, graduado en centímetros
 Pinze per affarrare l'utero, Isterometri, graduato in cm



COLLIN
25,0 cm, 9³/₄"
75-2375-25



BEACHAM
26,0 cm, 10¹/₄"
75-2376-26

Amniotom
Amniotome
Amniótomo
Amniotomo

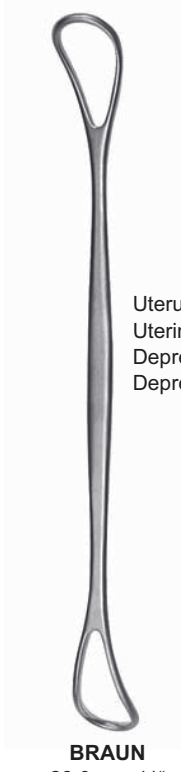

BRAUN
28,0 cm, 11"
75-2377-28

Uterus-Depressor
Uterine depressor
Depresor uterino
Depressori uterini



SIMS
32,0 cm, 12¹/₂"
75-2378-32



SIMS
32,0 cm, 12¹/₂"
75-2379-32

biegsam
malleable
maleable
malleabile



MARTIN
32,0 cm, 12¹/₂"
75-2380-32

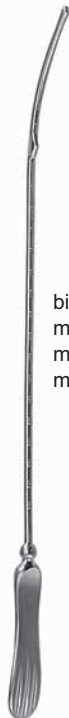

MARTIN
32,0 cm, 12¹/₂"
75-2381-32

biegsam
malleable
maleable
malleabile



VALLEIX
25,0 cm, 10"
75-2382-25



SIMPSON
29,0 cm, 11¹/₂"
75-2383-29

Ø 4 mm
biegsam
malleable
maleable
malleabile



COLLIN
28,0 cm, 11"
75-2384-28

Ø 4 mm

Biopsieküretten
Biopsy Curettes
Curetas para biopsia
Curette per biopsia



KEVORKIAN
30,0 cm, 12"
75-2385-30



KEVORKIAN
30,0 cm, 12"
75-2386-30



KEVORKIAN
30,0 cm, 12"
75-2387-30

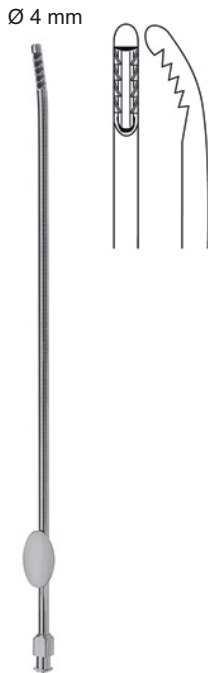

NOVAK
23,0 cm, 9"
75-2391-04

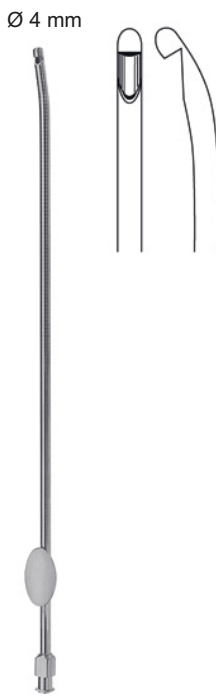

RANDALL
23,0 cm, 9"
75-2392-04



MILAN
29,0 cm, 11½"



Ø 4 mm
75-2388-04



Ø 4 mm
75-2389-04



Ø 4 mm
75-2390-04

Myominstrumente
Myoma Instruments
Instrumentos para mioma
Strumenti per fibroma

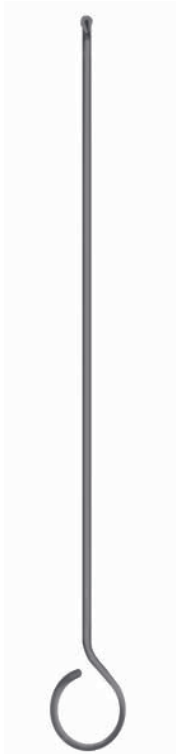

UTERUSPERFORATOR
25,0 cm, 9³/₄"
75-2393-25



FISTELHAKEN
25,0 cm, 9³/₄"
75-2394-25



SIMON
22,0 cm, 8⁵/₈"
75-2395-22



EMMETT
22,0 cm, 8⁵/₈"



75-2396-01



75-2396-02



75-2396-03



75-2396-04



75-2396-05



SEGOND
27,0 cm, 10⁵/₈"
75-2397-27



AYRE
23,0 cm, 9"
75-2397-23

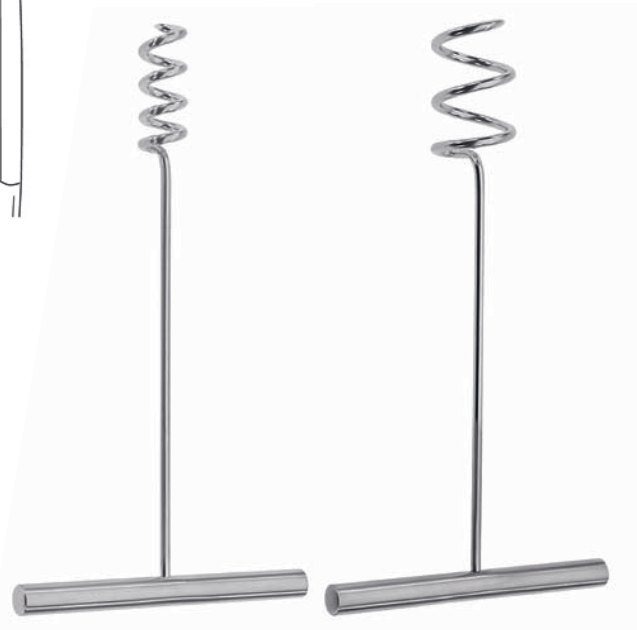
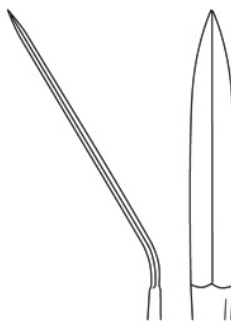

DOYEN
19,0 cm, 7¹/₂"
75-2397-01

DOYEN
17,0 cm, 6³/₄"
75-2397-02

Uterusküretten
Uterine Curettes
Curetas uterinas
Curette uterine

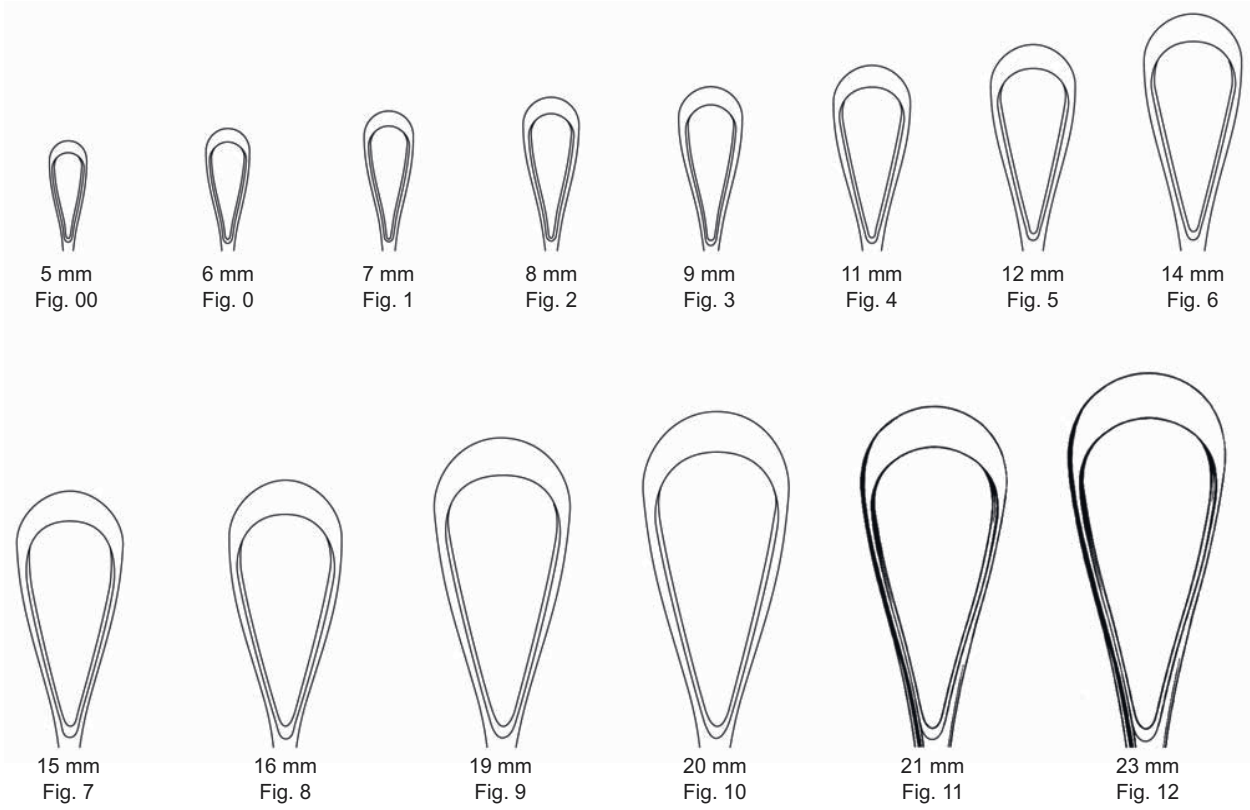

scharf, fest
 sharp, rigid
 cortantes, rígidas
 acute, rigide

Fig. 00	75-2398-05
Fig. 0	75-2398-06
Fig. 1	75-2398-07
Fig. 2	75-2398-08
Fig. 3	75-2398-09
Fig. 4	75-2398-11
Fig. 5	75-2398-12
Fig. 6	75-2398-14
Fig. 7	75-2398-15
Fig. 8	75-2398-16
Fig. 9	75-2398-19
Fig. 10	75-2398-20
Fig. 11	75-2398-21
Fig. 12	75-2398-23

RECAMIER
 26,0 cm, 10¹/₄"



scharf, biegsam
 sharp, malleable
 cortantes, maleable
 acute, malleabile

Fig. 00	75-2399-05
Fig. 0	75-2399-06
Fig. 1	75-2399-07
Fig. 2	75-2399-08
Fig. 3	75-2399-09
Fig. 4	75-2399-11
Fig. 5	75-2399-12
Fig. 6	75-2399-14
Fig. 7	75-2399-15
Fig. 8	75-2399-16
Fig. 9	75-2399-19
Fig. 10	75-2399-20
Fig. 11	75-2399-21
Fig. 12	75-2399-23

RECAMIER
 26,0 cm, 10¹/₄"

Uterusküretten
Uterine Curettes
Curetas uterinas
Curette uterine

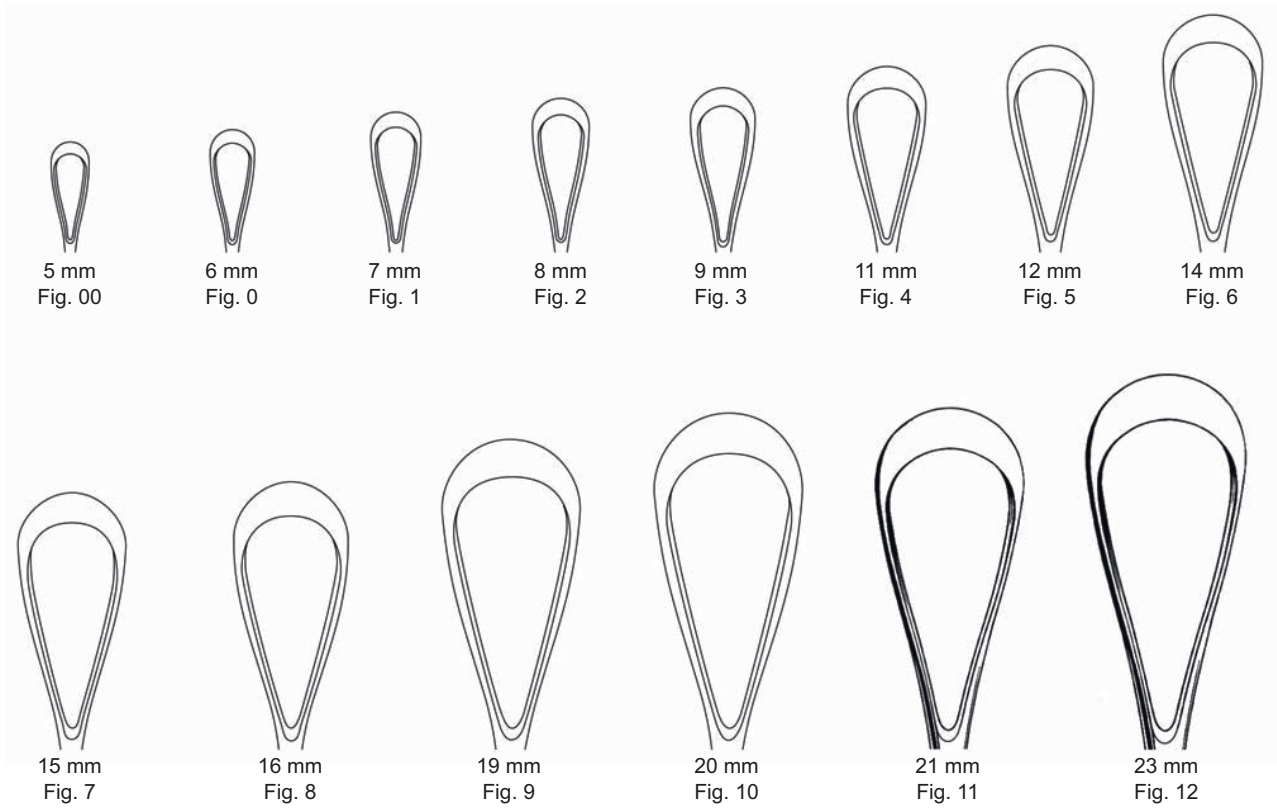

scharf, fest
sharp, rigid
cortantes, rigidas
acute, rigide

Fig. 00	75-2400-05
Fig. 0	75-2400-06
Fig. 1	75-2400-07
Fig. 2	75-2400-08
Fig. 3	75-2400-09
Fig. 4	75-2400-11
Fig. 5	75-2400-12
Fig. 6	75-2400-14
Fig. 7	75-2400-15
Fig. 8	75-2400-16
Fig. 9	75-2400-19
Fig. 10	75-2400-20
Fig. 11	75-2400-21
Fig. 12	75-2400-23

SIMS
26,0 cm, 10¹/₄"



scharf, biegsam
sharp, malleable
cortantes, maleable
acute, malleabile

Fig. 00	75-2401-05
Fig. 0	75-2401-06
Fig. 1	75-2401-07
Fig. 2	75-2401-08
Fig. 3	75-2401-09
Fig. 4	75-2401-11
Fig. 5	75-2401-12
Fig. 6	75-2401-14
Fig. 7	75-2401-15
Fig. 8	75-2401-16
Fig. 9	75-2401-19
Fig. 10	75-2401-20
Fig. 11	75-2401-21
Fig. 12	75-2401-23

SIMS
26,0 cm, 10¹/₄"

**Uterusküretten
Uterine Curettes
Curetas uterinas
Curette uterine**

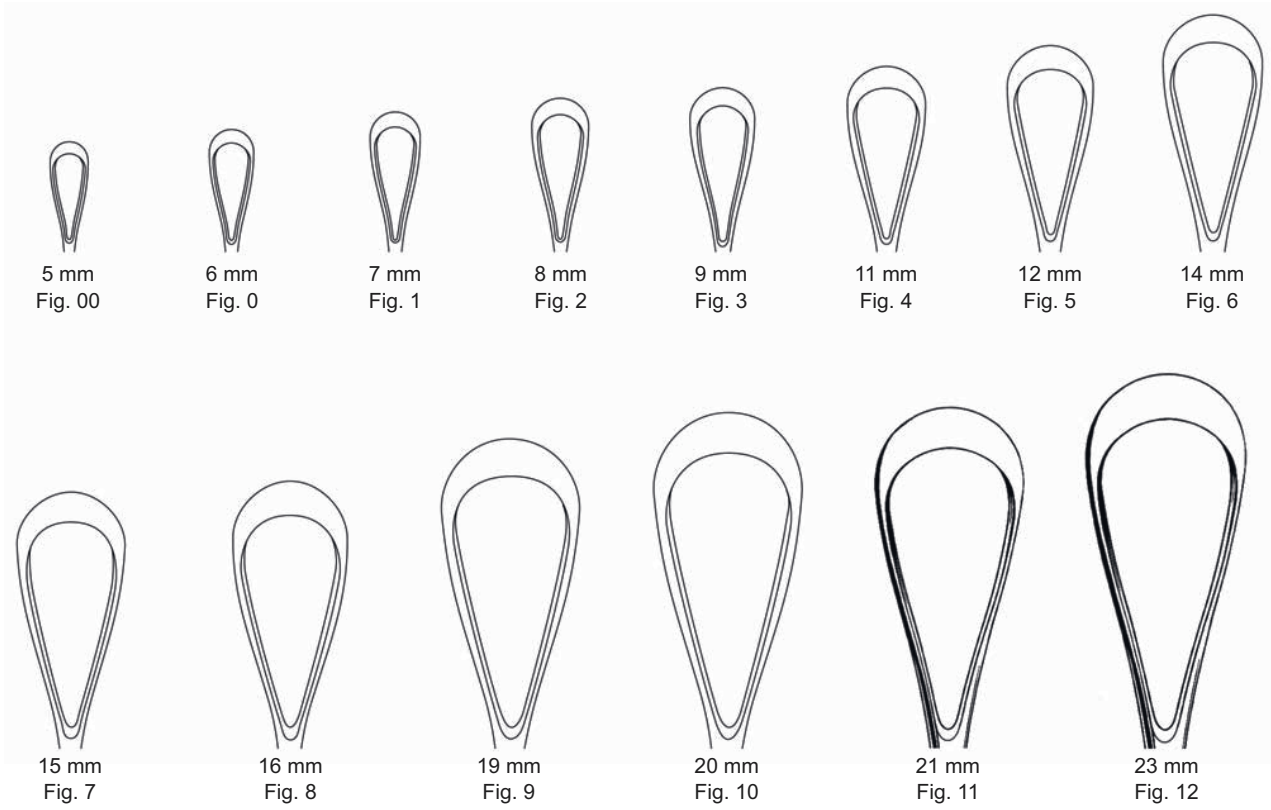

scharf, fest
sharp, rigid
cortantes, rígidas
acute, rigide

Fig. 00	75-2402-05
Fig. 0	75-2402-06
Fig. 1	75-2402-07
Fig. 2	75-2402-08
Fig. 3	75-2402-09
Fig. 4	75-2402-11
Fig. 5	75-2402-12
Fig. 6	75-2402-14
Fig. 7	75-2402-15
Fig. 8	75-2402-16
Fig. 9	75-2402-19
Fig. 10	75-2402-20
Fig. 11	75-2402-21
Fig. 12	75-2402-23

RECAMIER
31,0 cm, 12¹/₄"



scharf, biegsam
sharp, malleable
cortantes, maleable
acute, malleabile

Fig. 00	75-2403-05
Fig. 0	75-2403-06
Fig. 1	75-2403-07
Fig. 2	75-2403-08
Fig. 3	75-2403-09
Fig. 4	75-2403-11
Fig. 5	75-2403-12
Fig. 6	75-2403-14
Fig. 7	75-2403-15
Fig. 8	75-2403-16
Fig. 9	75-2403-19
Fig. 10	75-2403-20
Fig. 11	75-2403-21
Fig. 12	75-2403-23

RECAMIER
31,0 cm, 12¹/₄"

Uterusküretten
Uterine Curettes
Curetas uterinas
Curette uterine

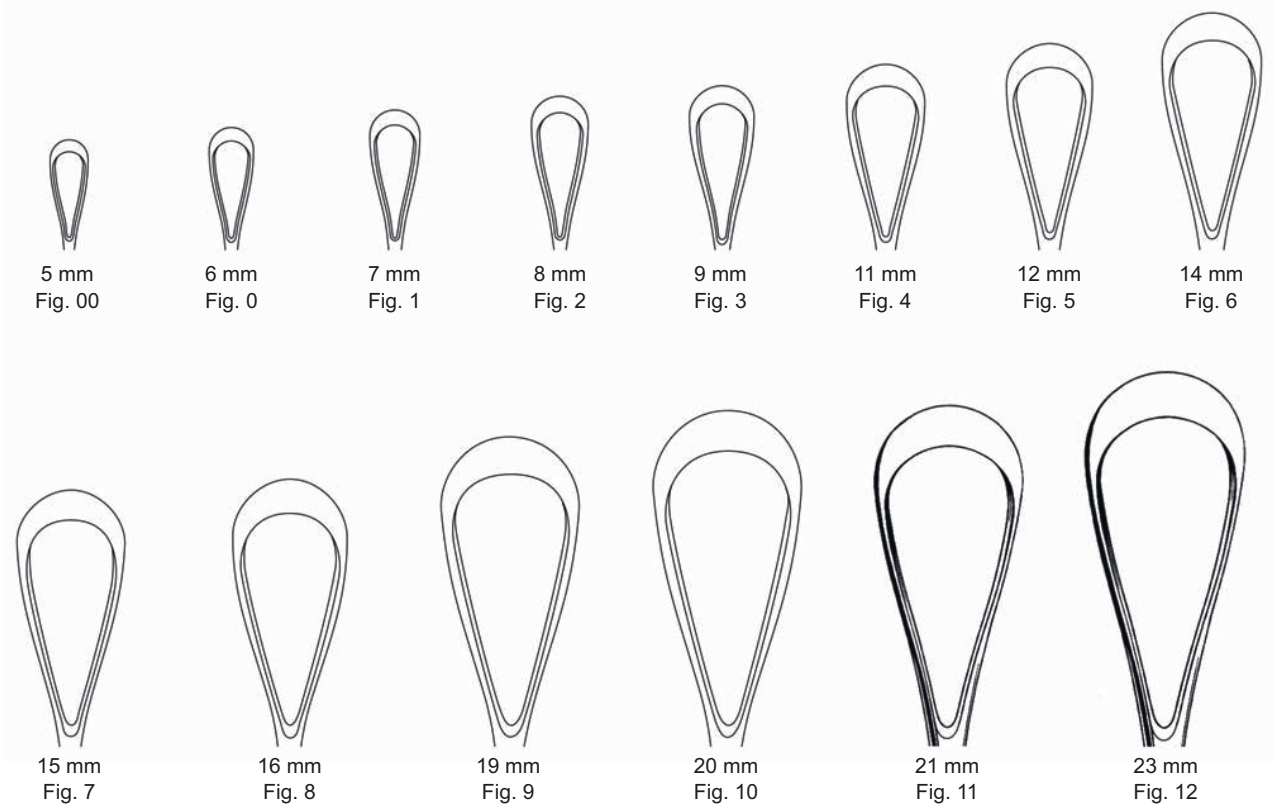

scharf, fest
sharp, rigid
cortantes, rígidas
acute, rigide

Fig. 00	75-2404-05
Fig. 0	75-2404-06
Fig. 1	75-2404-07
Fig. 2	75-2404-08
Fig. 3	75-2404-09
Fig. 4	75-2404-11
Fig. 5	75-2404-12
Fig. 6	75-2404-14
Fig. 7	75-2404-15
Fig. 8	75-2404-16
Fig. 9	75-2404-19
Fig. 10	75-2404-20
Fig. 11	75-2404-21
Fig. 12	75-2404-23

SIMS
31,0 cm, 12¹/₄"



scharf, biegsam
sharp, malleable
cortantes, maleable
acute, malleabile

Fig. 00	75-2405-05
Fig. 0	75-2405-06
Fig. 1	75-2405-07
Fig. 2	75-2405-08
Fig. 3	75-2405-09
Fig. 4	75-2405-11
Fig. 5	75-2405-12
Fig. 6	75-2405-14
Fig. 7	75-2405-15
Fig. 8	75-2405-16
Fig. 9	75-2405-19
Fig. 10	75-2405-20
Fig. 11	75-2405-21
Fig. 12	75-2405-23

SIMS
31,0 cm, 12¹/₄"

Uterusküretten
Uterine Curettes
Curetas uterinas
Curette uterine

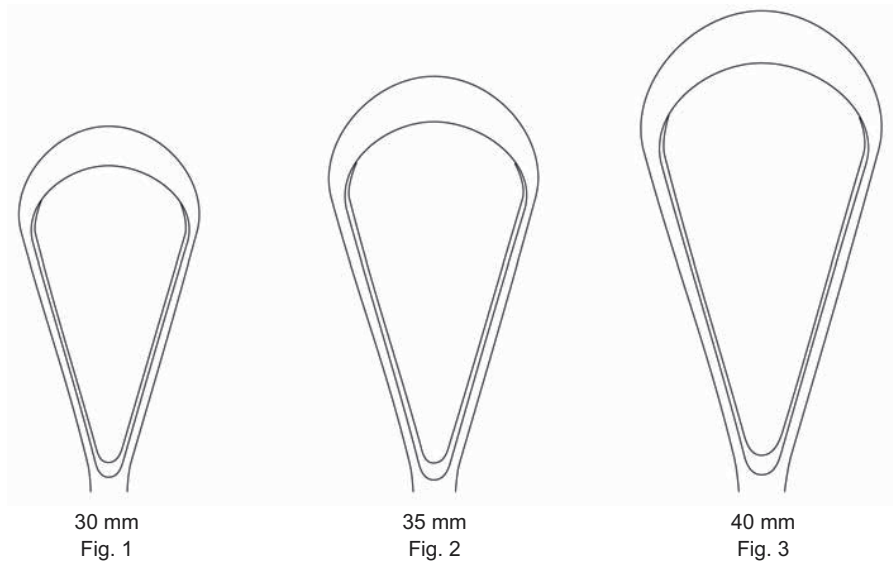

scharf, fest
 sharp, rigid
 cortantes, rígidas
 acute, rigide

Fig. 1	75-2406-30
Fig. 2	75-2406-35
Fig. 3	75-2406-40

SIMS
 31,0 cm, 12¹/₄"



scharf, biegsam
 sharp, malleable
 cortantes, maleable
 acute, malleabile

Fig. 1	75-2407-30
Fig. 2	75-2407-35
Fig. 3	75-2407-40

SIMS
 31,0 cm, 12¹/₄"

Uterusküretten
Uterine Curettes
Curetas uterinas
Curette uterine

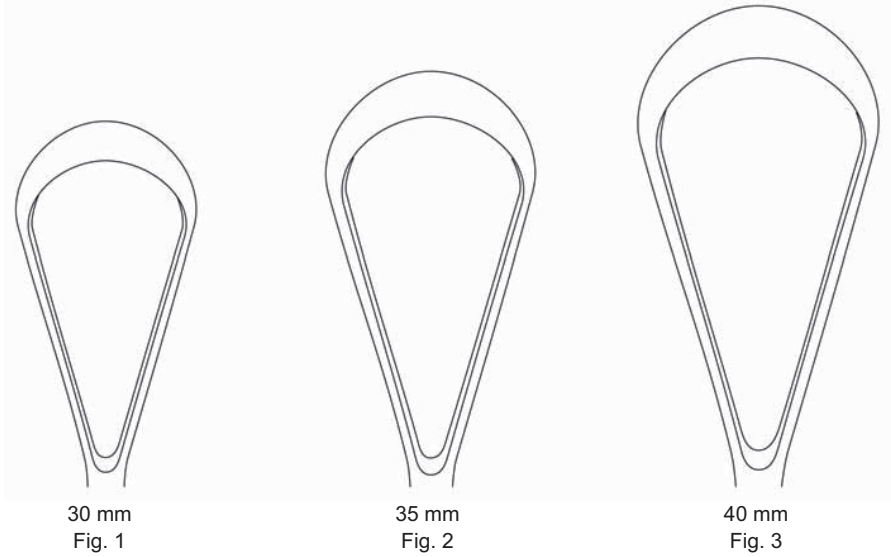

scharf, fest
sharp, rigid
cortantes, rígidas
acute, rigide

Fig. 1	75-2408-30
Fig. 2	75-2408-35
Fig. 3	75-2408-40

BUMM
31,0 cm, 12 1/4"



scharf, biegsam
sharp, malleable
cortantes, maleable
acute, malleabile

Fig. 1	75-2409-30
Fig. 2	75-2409-35
Fig. 3	75-2409-40

BUMM
31,0 cm, 12 1/4"

Uteruslöffel, Uterus-Biopsiezangen
Uterine Scoopes, Cervical Biopsy and Specimen Forceps
Cucharillas uterinas, Pinzas saca-bocados para biopsia
Curette uterine, Pinze per la biopsia cervicale e da prelievo



BLAKE
27,0 cm, 10⁵/₈"
75-1750-27



SIMON
25,0 cm, 9³/₄"

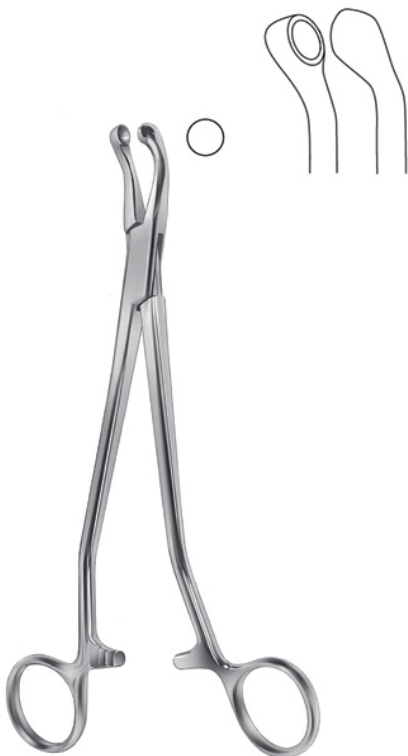
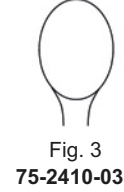
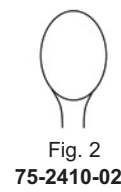
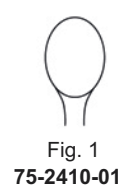

THOMS-GAYLOR
22,0 cm, 8⁵/₈" 75-2412-22
24,0 cm, 9¹/₂" 75-2412-24



29,0 cm, 11¹/₂" 75-2413-29



SCHUMACHER-VAN DOREN
24,0 cm, 9¹/₂"
75-2414-24

Uterus-Biopsiezangen
Cervical Biopsy and Specimen Forceps
Pinzas saca-bocados para biopsia
Pinze per la biopsia cervicale e da prelievo



THOMS-GAYLOR
24,0 cm, 9½"
75-2415-24



FAURE
21,0 cm, 8¼"
75-2416-21



SCHUBERT
26,0 cm, 10¼"
75-2417-26

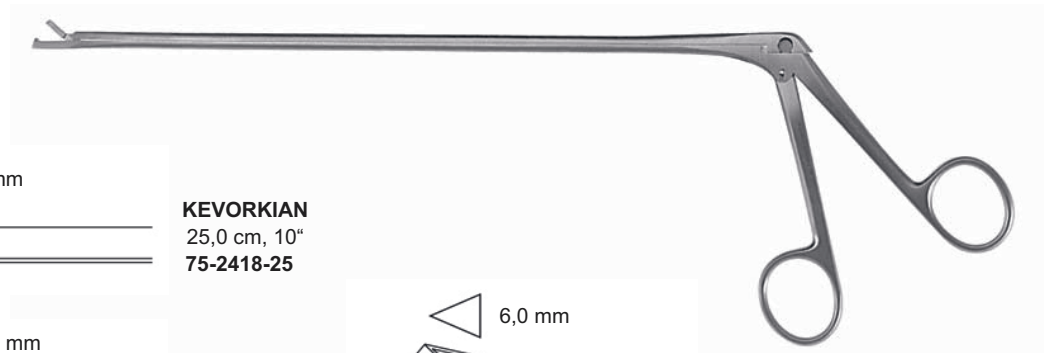

9 x 3 mm

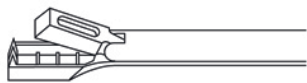

KEVORKIAN
25,0 cm, 10"
75-2418-25

4,5 x 8 mm

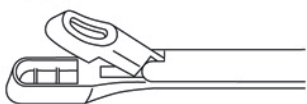

EPPENDORFER
20,0 cm, 8"
75-2419-20

6,0 mm

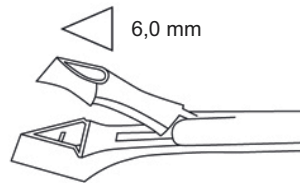

SCHUMACHER
24,0 cm, 9½"
75-2422-06

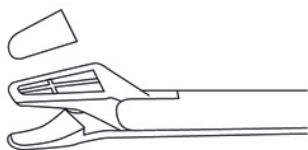

ALEXANDER
28,0 cm, 11"
75-2420-28

4,5 x 8 mm



WITTNER
23,0 cm, 9"
75-2423-23

4,0 mm

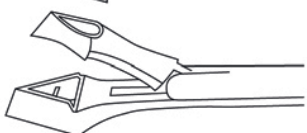

SCHUMACHER
24,0 cm, 9½"
75-2421-04

4,5 x 8 mm

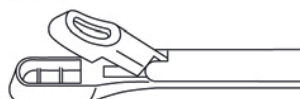

WITTNER
23,0 cm, 9"
75-2424-23

Uterus-Biopsiezangen
 Cervical Biopsy and Specimen Forceps
 Pinzas saca-bocados para biopsia
 Pinze per la biopsia cervicale e da prelievo

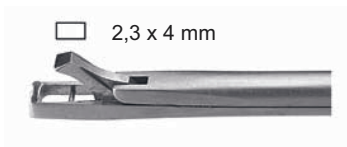
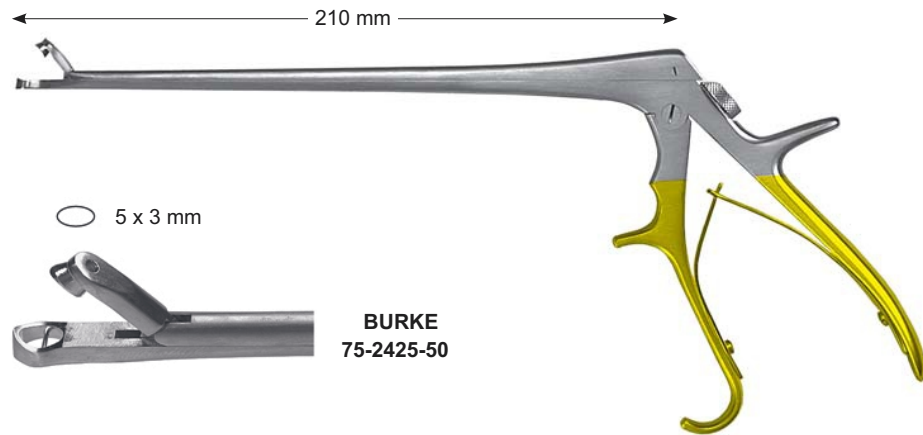

Geburtszangen
Obstetrical Forceps
Fórceps para obstétrica
Forbici per ostetricia



WRIGLEY
28,0 cm, 11"
75-2431-28



SIMPSON
30,0 cm, 11³/₄"
75-2432-30



SIMPSON-BRAUN
33,0 cm, 13"
75-2433-33



SIMPSON-BRAUN
36,0 cm, 14¹/₈"
75-2434-36



SIMPSON-LUIKART
36,0 cm, 14¹/₈"
75-2435-36



DE LEE
30,0 cm, 11³/₄"
75-2436-30



DE LEE
36,0 cm, 14¹/₈"
75-2437-36



DE LEE
38,0 cm, 15³/₈"
75-2438-38

Geburtszangen
Obstetrical Forceps
Fórceps para obstétrica
Forbici per ostetricia



MC LEAN
36,0 cm, 14¹/₈"
75-2439-36



KIELAND
41,0 cm, 16"
75-2440-41



KIELAND-LUIKART
40,0 cm, 15³/₄"
75-2441-40



PIPER
44,0 cm, 17¹/₄"
75-2442-44



ELLIOT
32,0 cm, 12¹/₂"
75-2443-32



ELLIOT
38,0 cm, 15"
75-2444-38



NAEGELE
36,0 cm, 14¹/₈"
75-2445-36



NAEGELE
40,0 cm, 15³/₄"
75-2446-40

Geburtszangen, Plazentar- und Abortuszangen
 Obstetrical Forceps, Placenta and Ovum Forceps
 Fórceps para obstétrica, Pinzas para aborto y placenta
 Forbici per ostetricia, Pinze per placenta e per ovaie



GREEN-ARMYTAGE
 21,0 cm, 8¹/₄"
 75-2447-21

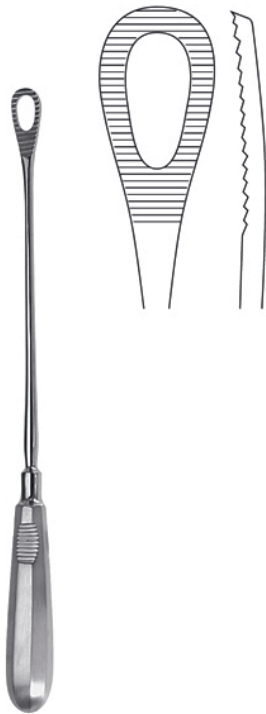

PESTALOZZA
 30,0 cm, 11³/₄"
 75-2448-30



SAENGER
 27,0 cm, 10⁵/₈"
 75-2249-27



SAENGER
 27,0 cm, 10⁵/₈"
 75-2450-27



WINTER
 28,0 cm, 11"



Fig. 1
 75-2451-01



Fig. 2
 75-2451-02



Fig. 3
 75-2451-03



Fig. 1
 75-2452-01

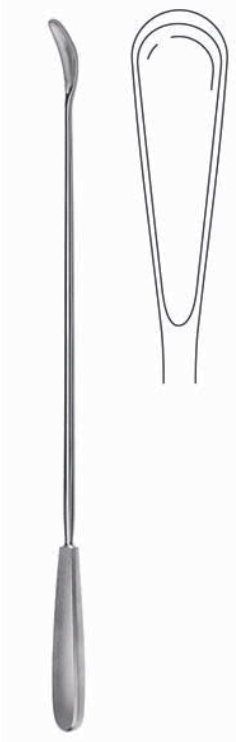

Fig. 2
 75-2452-02



Fig. 3
 75-2452-03

**Plazentar- und Abortuszangen
Placenta and Ovum Forceps
Pinzas para aborto y placenta
Pinze per placenta e per ovaie**



WALLICH
42,0 cm, 16½"
75-2453-42



MARTIN
34,0 cm, 13¾"
75-2454-34



BIERER
33,0 cm, 13"
75-2455-01



BIERER
33,0 cm, 13"
75-2456-02



BIERER
33,0 cm, 13"
75-2457-01



BIERER
33,0 cm, 13"
75-2458-02