



Klemmen

Forceps

Pinas

Pinze

Bulldogklemmen
Bulldog Clamps
Clamps Bulldog
Pinze Bulldog



3,5 cm, 1 1/2"	75-1521-03	75-1522-03
5,0 cm, 2"	75-1521-05	75-1522-05



DIEFFENBACH



HESS
75-1523-01



HESS
75-1524-02



3,8 cm, 1 1/2"	75-1525-04	75-1526-04
5,0 cm, 2"	75-1525-05	75-1526-05
6,3 cm, 2 1/2"	75-1525-06	75-1526-06
7,6 cm, 3"	75-1525-07	75-1526-07
9,0 cm, 3 1/2"	75-1525-09	75-1526-09

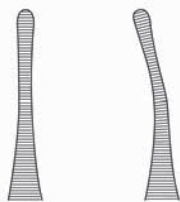

JOHNS-HOPKINS



JOHNS-HOPKINS
23,0 cm, 9"
75-1527-23

Bulldogklemmen
Bulldog Clamps
Clamps Bulldog
Pinze Bulldog

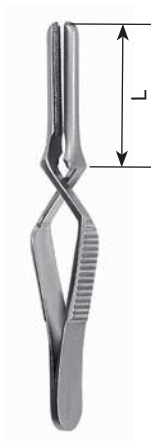

mit atraumatischer Riefung
with non-traumatic serration
con bocas atraumáticas
con presa atraumatica

		L	
7,5 cm, 3"	75-1528-07	2,5 cm, 1"	
8,5 cm, 3 1/4"	75-1528-08	3,5 cm, 1 3/8"	
10,5 cm, 4 1/8"	AK-1528-10	5,0 cm, 2"	
12,0 cm, 4 3/4"	AK-1528-12	6,8 cm, 2 3/4"	

DE BAKEY



mit atraumatischer Riefung
with non-traumatic serration
con bocas atraumáticas
con presa atraumatica

		L	
7,0 cm, 2 3/4"	75-1529-07	2,5 cm, 1"	
8,0 cm, 3 1/8"	75-1529-08	3,5 cm, 1 3/8"	
10,0 cm, 3 3/4"	75-1529-10	5,0 cm, 2"	
11,5 cm, 4 1/2"		6,8 cm, 2 3/4"	

DE BAKEY



TITANIUM
3,5 cm, 1 3/8"
vena **75-1530-35**
arteria **AK-1531-35**



TITANIUM
3,5 cm, 1 3/8"
vena **75-1532-35**
arteria **75-1533-35**



TITANIUM
4,0 cm, 1 5/8"
vena **75-1534-40**
arteria **75-1535-40**



TITANIUM
4,0 cm, 1 5/8"
vena **75-1536-40**
arteria **75-1537-40**

Bulldogklemmen, Darm- und Gewebefaßzangen
Bulldog Clamps, Intestinal and Tissue Grasping Forceps
Clamps Bulldog, Pinzas intestinales y para tejidos
Pinze Bulldog, Pinze da presa per intestino e tessuti

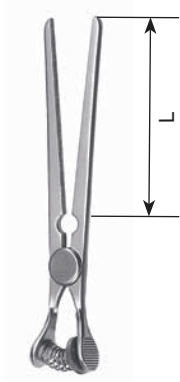

		L	
6,8 cm, 2 ³ / ₄ "	75-1538-07	3,3 cm, 1 ³ / ₈ "	
9,6 cm, 3 ³ / ₄ "	75-1538-09	5,0 cm, 2"	
11,7 cm, 4 ³ / ₄ "	75-1538-11	6,9 cm, 2 ³ / ₄ "	

GLOVER

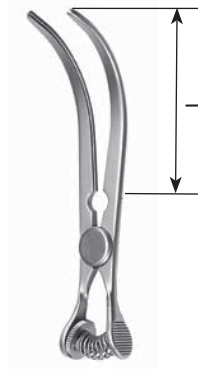

		L	
6,5 cm, 2 ¹ / ₂ "	AK-1539-06	3,3 cm, 1 ³ / ₈ "	
9,1 cm, 3 ¹ / ₂ "	75-1539-09	5,0 cm, 2"	
11,0 cm, 4 ³ / ₈ "	75-1539-11	6,9 cm, 2 ³ / ₄ "	

GLOVER



CHAPUT
 13,0 cm, 5"
75-1540-13



TUFFIER
 13,0 cm, 5"
75-1541-13



COLLIN
 16,0 cm, 6¹/₄"
75-1542-16

Darm- und Gewebefäßzangen
Intestinal and Tissue Grasping Forceps
Pinzas intestinales y para tejidos
Pinze da presa per intestino e tessuti



PENNINGTON

15,5 cm, 6"	75-1543-15
20,0 cm, 8"	75-1543-20



ATRAUMA



25,0 cm, 9³/₄"
75-1544-25



27,0 cm, 10¹/₂"
75-1544-27



MARTEL

14,0 cm, 5¹/₂"
75-1545-14

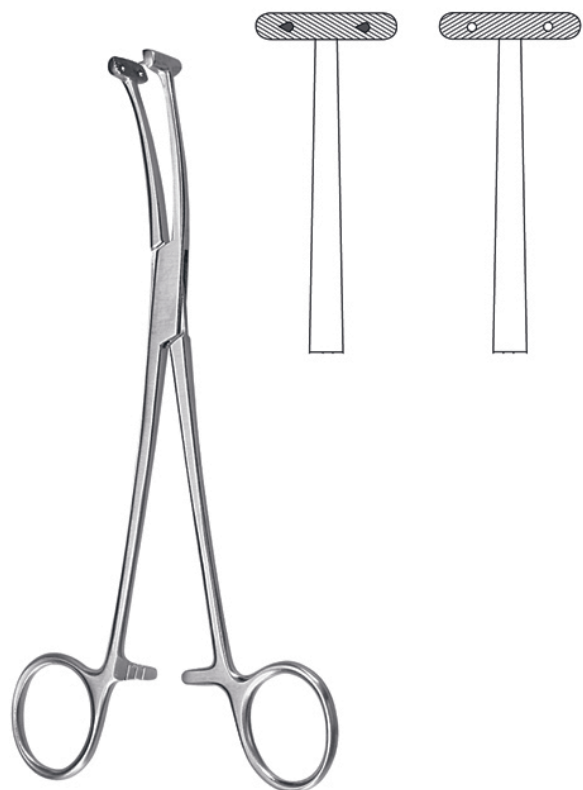

WILLET-MARTEL

19,0 cm, 7¹/₂"
75-1546-19

Arterienklemmen
Haemostatic Forceps
Pinzas hemostáticas
Pinze emostatiche



PRATT
15,0 cm, 6"
75-1549-15



FERGUSSON

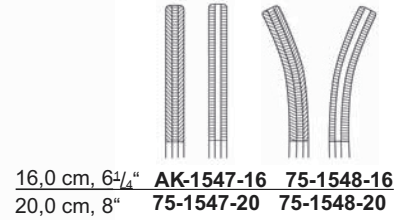

CARREL
10,0 cm, 4"
75-1550-10



TERRIER
10,0 cm, 4"
75-1551-10



KROENLEIN
13,0 cm, 5"
75-1552-13

Arterienklemmen
Haemostatic Forceps
Pinzas hemostáticas
Pinze emostatiche



PEAN

14,0 cm, 5½"	75-1555-14
16,0 cm, 6¼"	75-1555-16



BABY-MIXTER

14,0 cm, 5½"

75-1553-01

75-1554-02



SPENCER-WELLS

13,0 cm, 5"	75-1556-13 AK -1557-13
15,0 cm, 6"	AK-1556-15 AK -1557-15
18,0 cm, 7"	AK-1556-18 AK -1557-18
20,0 cm, 8"	75-1556-20 75-1557-20



HARTMANN

10,0 cm, 4"

75-1558-10

75-1559-10

Arterienklemmen
Haemostatic Forceps
Pinzas hemostáticas
Pinze emostatiche

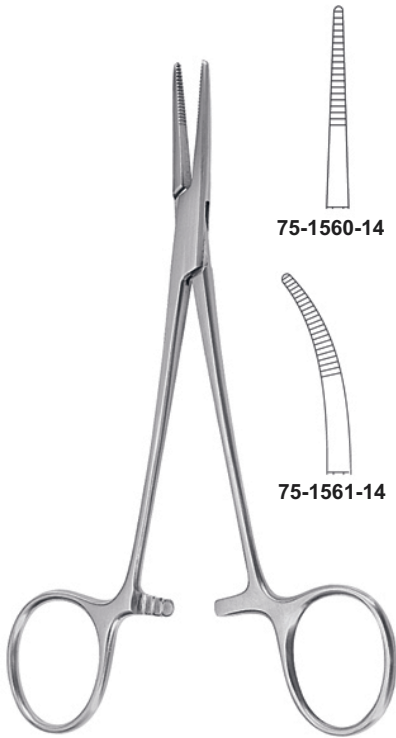

75-1560-14

75-1561-14

PROVINCENCE-HOSPITAL
14,0 cm, 5 1/2"



12,5 cm, 5" **75-1562-12** **75-1563-12**
25,0 cm, 9 3/4" **75-1562-14** **75-1563-14**

1 x 2 1 x 2
12,5 cm, 5" **75-1564-12** **75-1565-12**
25,0 cm, 9 3/4" **75-1564-14** **75-1565-14**

HALSTED-MOSQUITO



HALSTED-MOSQUITO



18,0 cm, 7"
75-1565-18



18,0 cm, 7"
75-1566-18





21,0 cm, 8 1/4"
75-1567-21



21,0 cm, 8 1/4"
75-1568-21

1 x 2

18,0 cm, 7"
75-1569-18



1 x 2

18,0 cm, 7"
75-1570-18

1 x 2

21,0 cm, 8 1/4"
75-1571-21

1 x 2

21,0 cm, 8 1/4"
75-1572-21

Arterienklemmen
Haemostatic Forceps
Pinzas hemostáticas
Pinze emostatiche

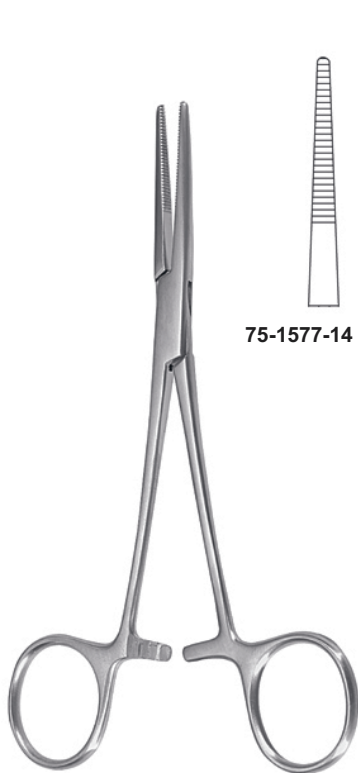

			1 x 2	1 x 2
				
10,0 cm, 4"	75-1573-10	75-1574-10	75-1575-10	75-1576-10
12,0 cm, 4 ³ / ₄ "	75-1573-12	75-1574-12	75-1575-12	75-1576-12

MICRO-MOSQUITO



75-1577-14



75-1578-14

KELLY
14,0 cm, 5¹/₂"

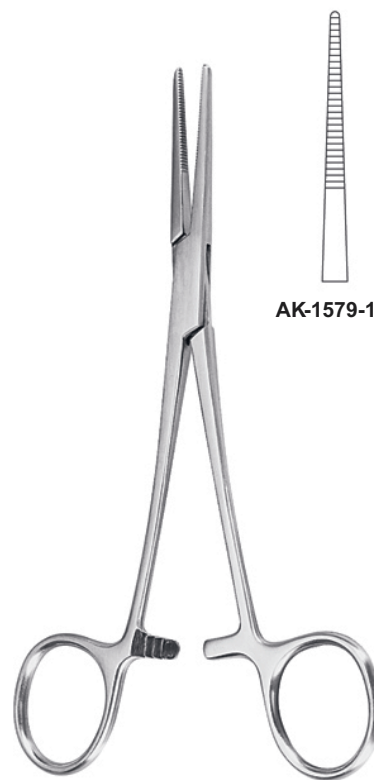

AK-1579-16



75-1580-16

KELLY-RANKIN
16,0 cm, 6¹/₄"

Arterienklemmen
Haemostatic Forceps
Pinzas hemostáticas
Pinze emostatiche



LERICHE
15,0 cm, 6"



75-1581-15



75-1582-15

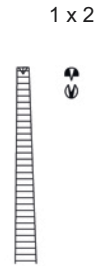

75-1583-15



75-1584-15



BABY-OVERHOLT
13,5 cm, 5 1/4"
75-1585-14

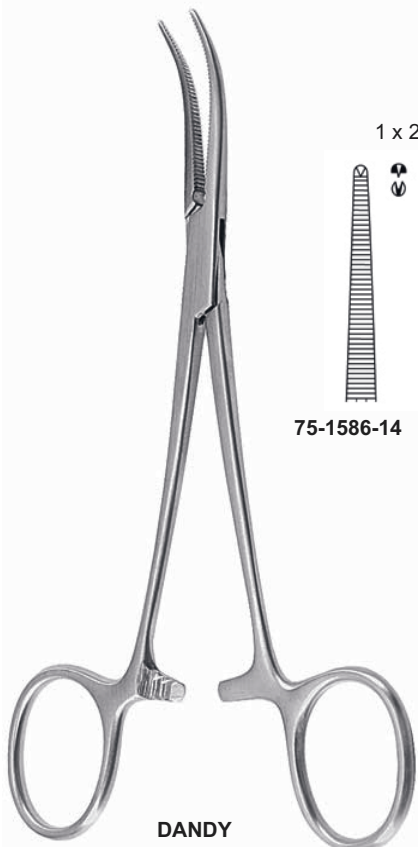

DANDY
14,0 cm, 5 1/2"



75-1586-14



CRILE



75-1587-14



75-1588-14



75-1589-14

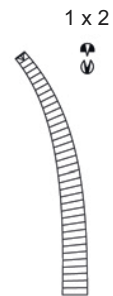

75-1590-14

14,0 cm, 5 1/2"

Arterienklemmen
Haemostatic Forceps
inzas hemostáticas
Pinze emostatiche

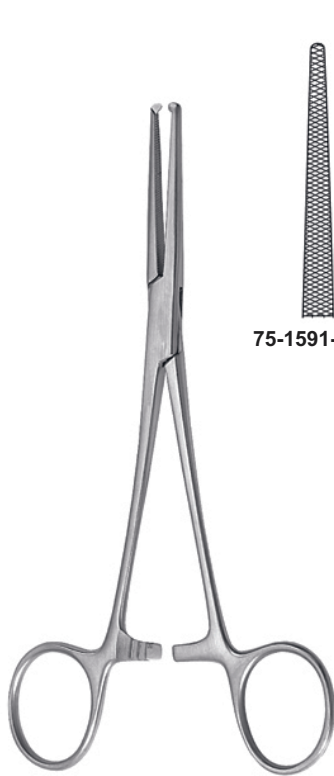

DIXON-LOVELACE
15,0 cm, 6"

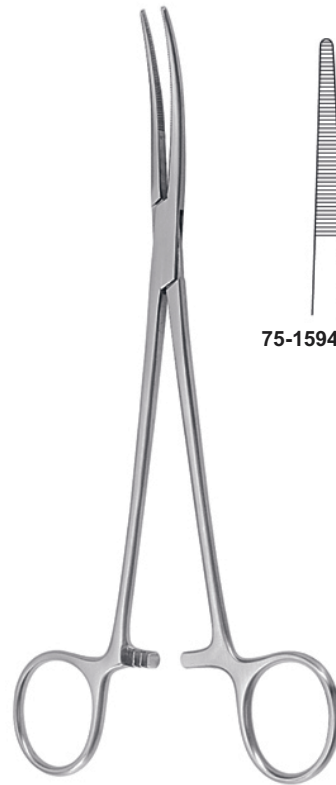
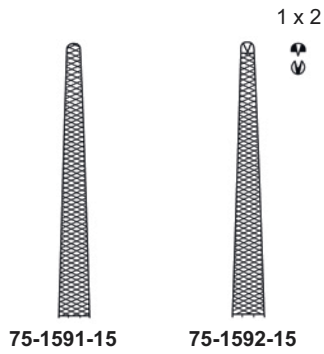

BIRKETT
19,0 cm, 7 1/2"

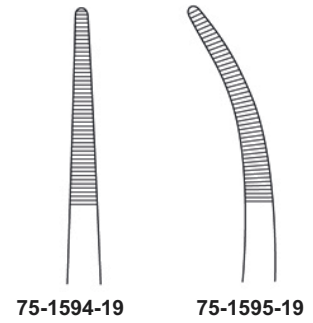

CRILE-RANKIN
16,0 cm, 6 1/4"

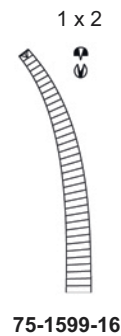
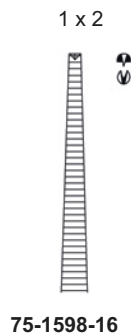
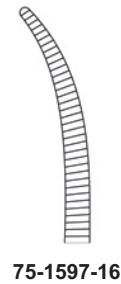
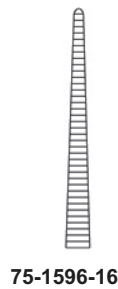

Arterienklemmen
Haemostatic Forceps
Pinzas hemostáticas
Pinze emostatiche



75-1600-19

SCHNIDT
19,0 cm, 7 1/2"

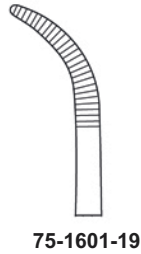

75-1601-19



75-1602-19

75-1603-19

SCHNI75-SAWTELL
19,0 cm



ADSON
18,5 cm, 7 1/4"



75-1604-16

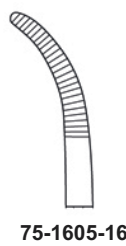

75-1605-16

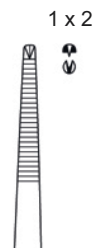

75-1606-16

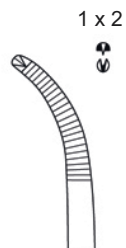

75-1607-16

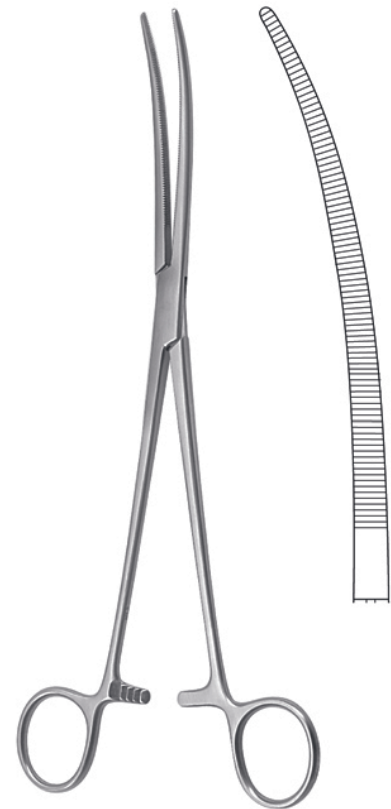

CRAFOORD
24,0 cm, 9 1/2"
75-1608-24

Arterienklemmen
Haemostatic Forceps
Pinzas hemostáticas
Pinze emostatiche



15,0 cm, 6" **75-1609-15 75-1610-15**
18,5 cm, 7 1/4" **75-1609-18 75-1610-18**

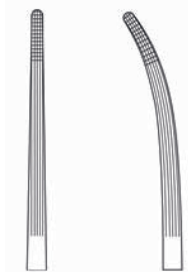

BAINBRIDGE



16,0 cm, 6 1/4" **75-1611-16 75-1612-16**
20,0 cm, 8" **75-1611-20 75-1612-20**

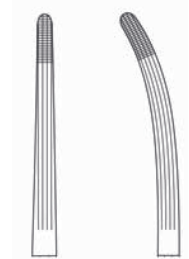

ROCHESTER-CARMALT



13,0 cm, 5" **75-1613-13 75-1614-13**
14,0 cm, 5 1/2" **75-1613-14 75-1614-14**
16,0 cm, 6 1/4" **75-1613-16 75-1614-16**

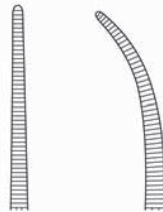

PEAN DELICATE



13,0 cm, 5" **75-1615-13 75-1616-13**
14,0 cm, 5 1/2" **75-1615-14 75-1616-14**
16,0 cm, 6 1/4" **75-1615-16 75-1616-16**

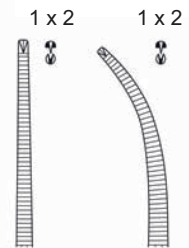

KOCHER DELICATE

Arterienklemmen
Haemostatic Forceps
Pinzas hemostáticas
Pinze emostatiche

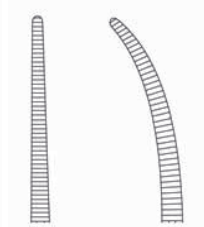

14,0 cm, 5 1/2"	75-1617-14	75-1618-14
16,0 cm, 6 1/4"	75-1617-16	75-1618-16
18,0 cm, 7"	75-1617-18	75-1618-18
20,0 cm, 8"	75-1617-20	75-1618-20
22,0 cm, 8 5/8"	75-1617-22	75-1618-22
24,0 cm, 9 1/2"	75-1617-24	75-1618-24
26,0 cm, 10 1/4"	75-1617-26	75-1618-26
30,0 cm, 12"	75-1617-30	75-1618-30

ROCHESTER-PEAN

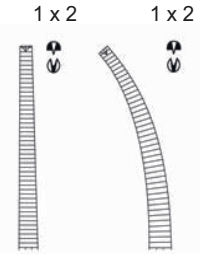
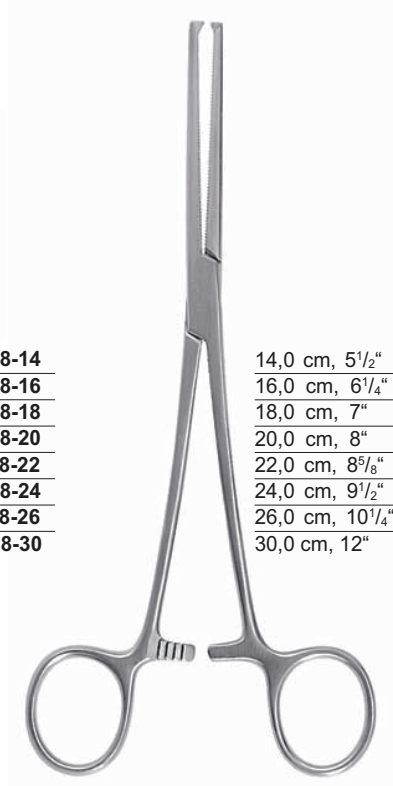

14,0 cm, 5 1/2"	75-1619-14	75-1620-14
16,0 cm, 6 1/4"	75-1619-16	75-1620-16
18,0 cm, 7"	75-1619-18	75-1620-18
20,0 cm, 8"	75-1619-20	75-1620-20
22,0 cm, 8 5/8"	75-1619-22	75-1620-22
24,0 cm, 9 1/2"	75-1619-24	75-1620-24
26,0 cm, 10 1/4"	75-1619-26	75-1620-26
30,0 cm, 12"	75-1619-30	75-1620-30

KOCHER-OCHSNER

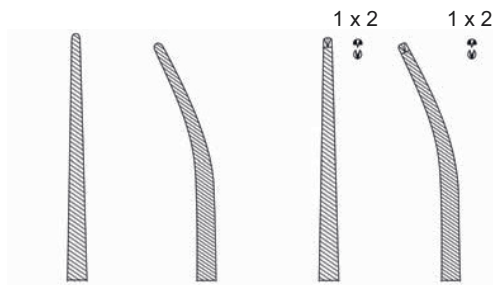

20,0 cm, 8"	75-1621-20	75-1622-20	75-1623-20	75-1624-20
26,0 cm, 10 1/4"	75-1621-26	75-1622-26	75-1623-26	75-1624-26

BENGOLEA

Arterienklemmen
Haemostatic Forceps
Pinzas hemostáticas
Pinze emostatiche

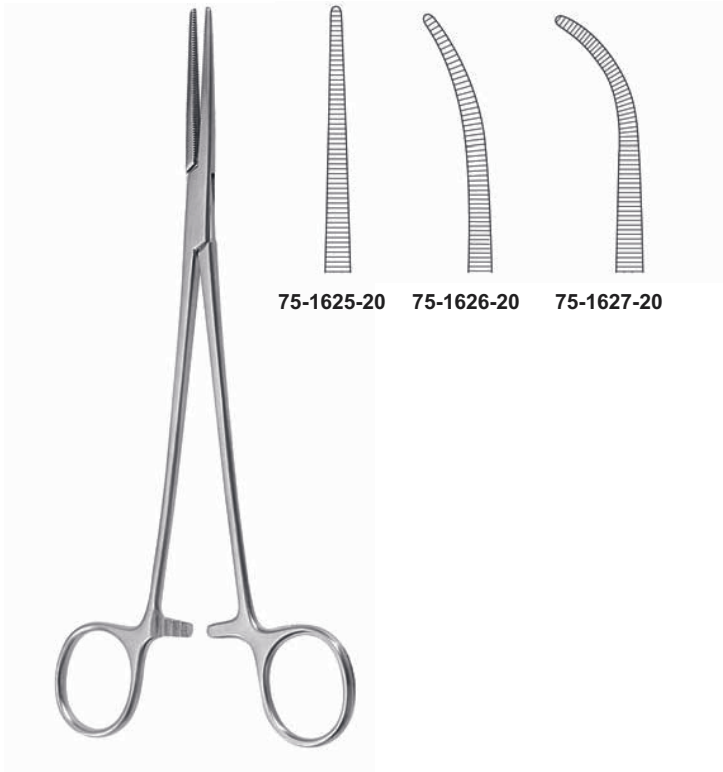

75-1625-20 75-1626-20 75-1627-20

HEISS
20,0 cm, 8"

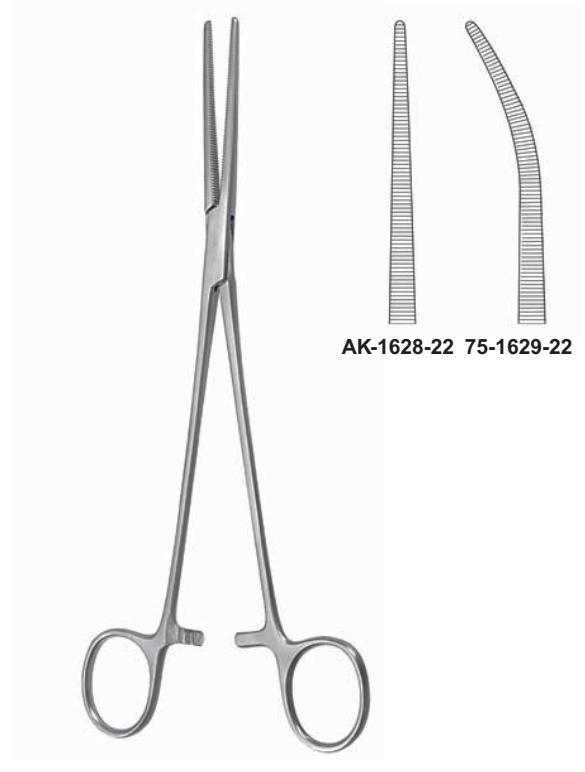

AK-1628-22 75-1629-22

ROBERTS
22,0 cm, 8⁵/₈"



AK-1630-24 75-1631-24

SAROT
24,0 cm, 9¹/₂"



AK-1632-01 75-1633-02

NEGUS
19,0 cm, 7¹/₂"

**Präparier- und Ligaturklemmen
Dissecting and Ligature Forceps
Pinzas de disección y ligaduras
Pinze per preparazioni e legature**



14,0 cm, 5½" 75-1634-14
18,0 cm, 7" 75-1635-18

BABY-ADSON



MICRO-ADSON
14,0 cm, 5½"
75-1636-14



BABY-MIXTER
18,0 cm, 7"
75-1637-18



OVERHOLT-MIXTER
21,0 cm, 8¼"
75-1638-21



JOHNS HOPKINS
20,0 cm, 8"
75-1639-20

Präparier- und Ligaturklemmen
Dissecting and Ligature Forceps
Pinzas de disección y ligaduras
Pinze per preparazioni e legature



OVERHOLT

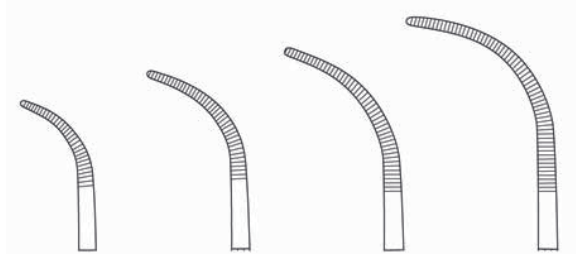

18,5 cm, 7¹/₄"
75-1640-01

20,0 cm, 8"
75-1640-02

21,0 cm, 8¹/₄"
75-1640-03

21,5 cm, 8¹/₂"
75-1640-04



RUMEL
23,0 cm, 9"

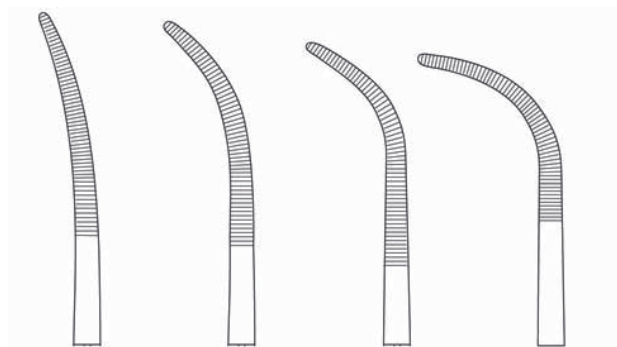

AK-1641-01

AK-1641-02

AK-1641-03

75-1641-04

Präparier- und Ligaturklemmen
Dissecting and Ligature Forceps
Pinzas de disección y ligaduras
Pinze per preparazioni e legature



OVERHOLT-GEISSENDOERFER

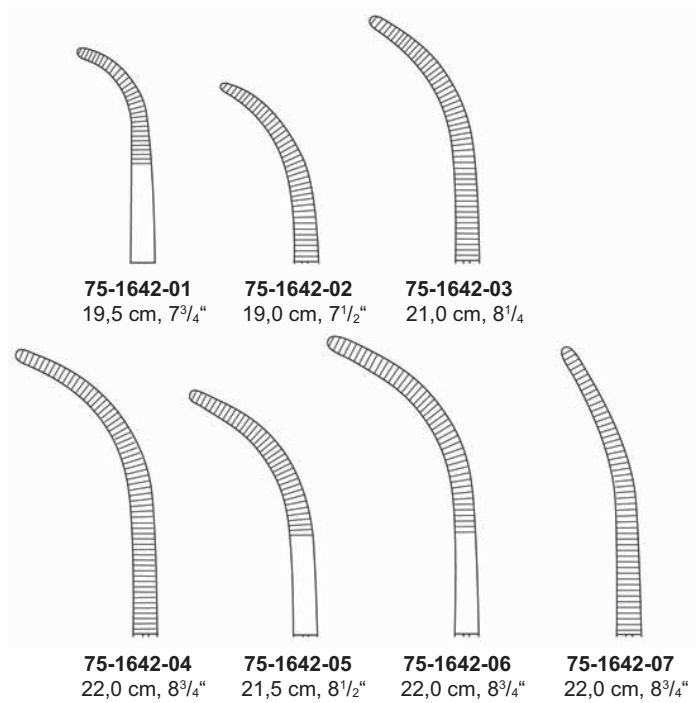

OVERHOLT-GEISSENDOERFER

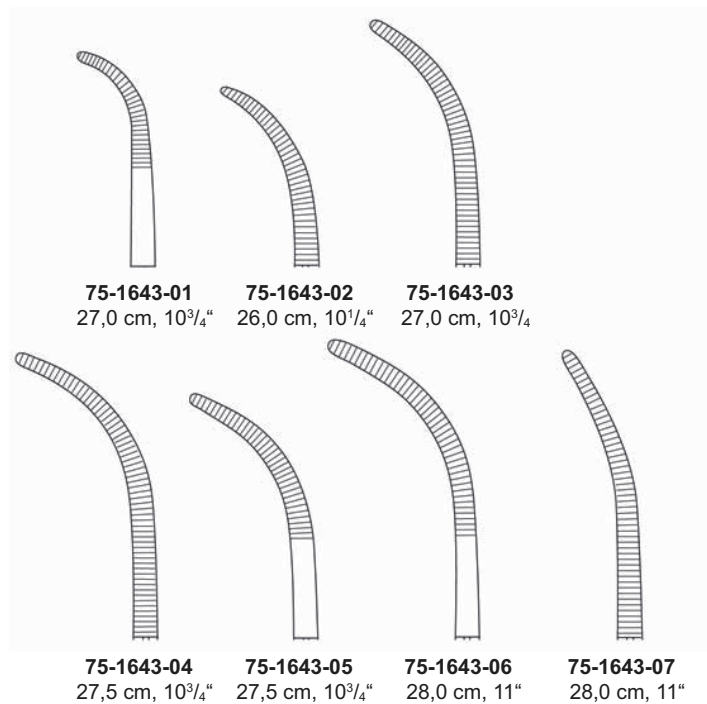

Präparier- und Ligaturklemmen
Dissecting and Ligature Forceps
Pinzas de disección y ligaduras
Pinze per preparazioni e legature

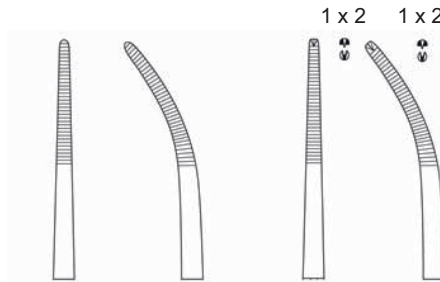

21,0 cm, 8 ¹ / ₄ "	75-1644-21	75-1645-21	75-1646-21	75-1647-21
26,0 cm, 10 ¹ / ₄ "	AK-1644-26	75-1645-26	75-1646-26	75-1647-26

TOENNIS

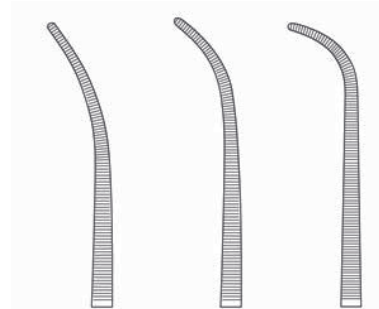

19,0 cm, 7 ¹ / ₂ "	75-1648-19	75-1649-19	75-1650-19
22,0 cm, 8 ⁵ / ₈ "	75-1648-22	75-1649-22	75-1650-22
24,0 cm, 9 ¹ / ₂ "	75-1648-24	75-1649-24	75-1650-24

KELLY

Präparier- und Ligaturklemmen
Dissecting and Ligature Forceps
Pinzas de disección y ligaduras
Pinze per preparazioni e legature



18,0 cm, 7"	75-1651-18
22,0 cm, 8 ⁵ / ₈ "	75-1651-22
25,0 cm, 9 ³ / ₄ "	75-1651-25
28,0 cm, 11"	75-1651-28

MINI-GEMINI

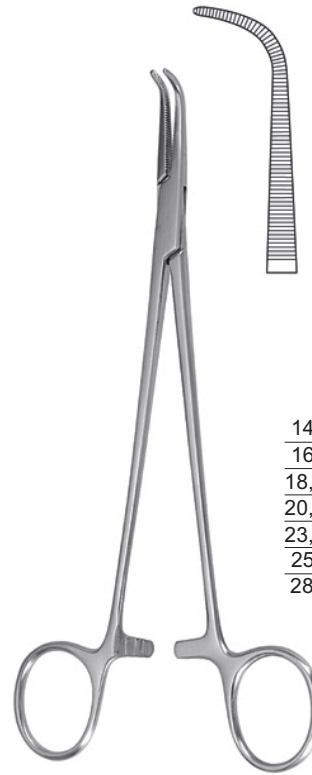

14,0 cm, 5 ¹ / ₂ "	75-1652-14
16,0 cm, 6 ¹ / ₄ "	75-1652-16
18,0 cm, 7"	75-1652-18
20,0 cm, 8"	75-1652-20
23,0 cm, 9"	75-1652-23
25,0 cm, 9 ³ / ₄ "	75-1652-25
28,0 cm, 11"	75-1652-28

GEMINI



20,0 cm, 8"	75-1653-20
24,0 cm, 9 ¹ / ₂ "	75-1653-24
28,0 cm, 11"	75-1653-28

KANTROWITZ



19,0 cm, 7 ¹ / ₂ "	75-1654-19
21,0 cm, 8 ¹ / ₄ "	75-1654-21
24,0 cm, 9 ¹ / ₂ "	75-1654-24

WIKSTROEM

Präparier- und Ligaturklemmen
Dissecting and Ligature Forceps
Pinzas de disección y ligaduras
Pinze per preparazioni e legature



MIXTER
15,5 cm, 6" **AK-1655-15**
19,0 cm, 7½" **AK-1655-19**



MIXTER-O'SHAUGNESSY
15,5 cm, 6" **75-1656-15**
19,0 cm, 7½" **75-1656-19**



MIXTER
22,0 cm, 8¾" **75-1657-22**



MIXTER
23,0 cm, 9" **75-1473-23**

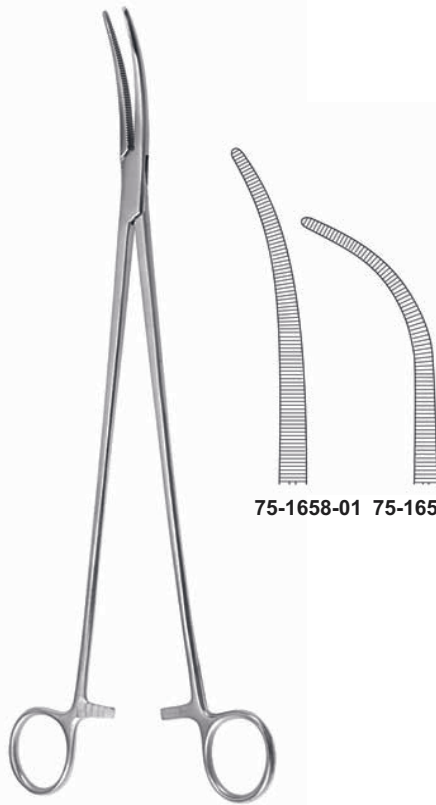

ZENKER

75-1658-01 75-1659-02



ZENKER

AK-1660-18 75-1661-28

Präparier- und Ligaturklemmen
Dissecting and Ligature Forceps
Pinzas de disección y ligaduras
Pinze per preparazioni e legature



LAWRENCE
27,5 cm, 10³/₄"
75-1664-28



HOSEMANN
21,0 cm, 8¹/₄"

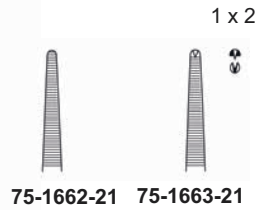

DESJARDINS
21,0 cm, 8¹/₄"
75-1665-21

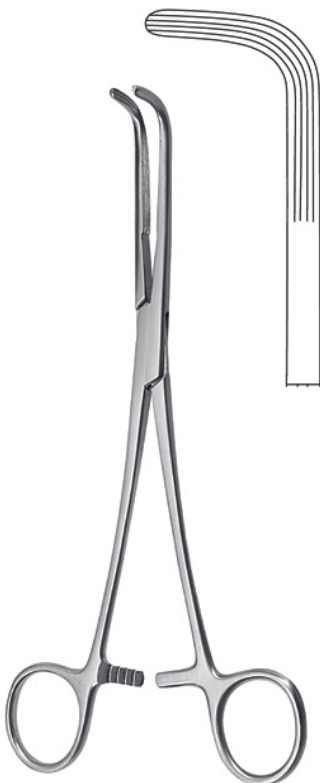

MIXTER
22,0 cm, 8³/₄" 75-1666-22
25,0 cm, 9³/₄" 75-1666-25
28,0 cm, 11" 75-1666-28

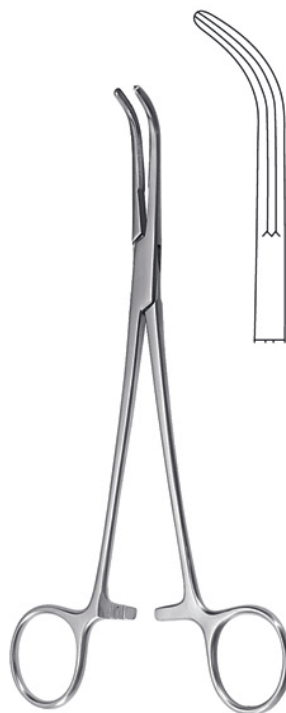

LAHEY
19,0 cm, 7¹/₂" 75-1667-19
23,0 cm, 9" 75-1667-23



18,0 cm, 7"
75-1668-18

Präparier- und Ligaturklemmen
Dissecting and Ligature Forceps
Pinzas de disección y ligaduras
Pinze per preparazioni e legature



MC QUIGG-MIXTER
22,0 cm, 8³/₄"
AK-1671-22

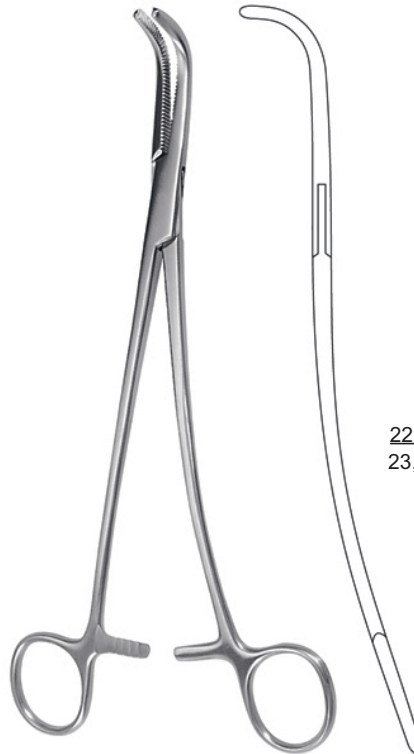

GRAY

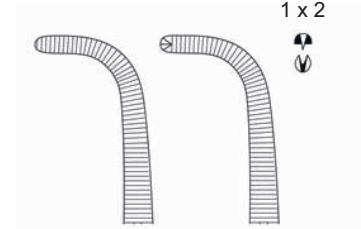

22,0 cm, 8³/₄" 75-1669-22 75-1670-22
23,0 cm, 9" 75-1669-23 75-1670-23



CRAFOORD-SELLORS

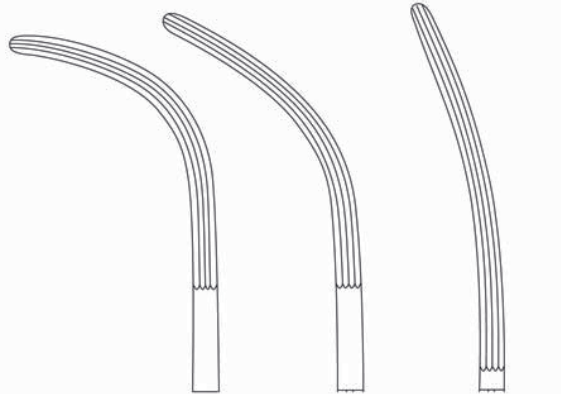

22,0 cm, 8³/₄" 75-1672-22
23,0 cm, 9" 75-1673-23
24,0 cm, 9¹/₂" 75-1674-24



FINOCCHIETTO
24,0 cm, 9¹/₂"
75-1675-24

Gallenkanal- und Nierenstielklemmen
 Gall Duct and Kidney Pedicle Clamps
 Pinzas-clamps para pedúnculo renal
 Pinze per peduncoli renali



GUYON

20,0 cm, 8"	75-1676-20
22,0 cm, 8 ³ / ₄ "	75-1676-22
24,0 cm, 9 ¹ / ₂ "	75-1676-24

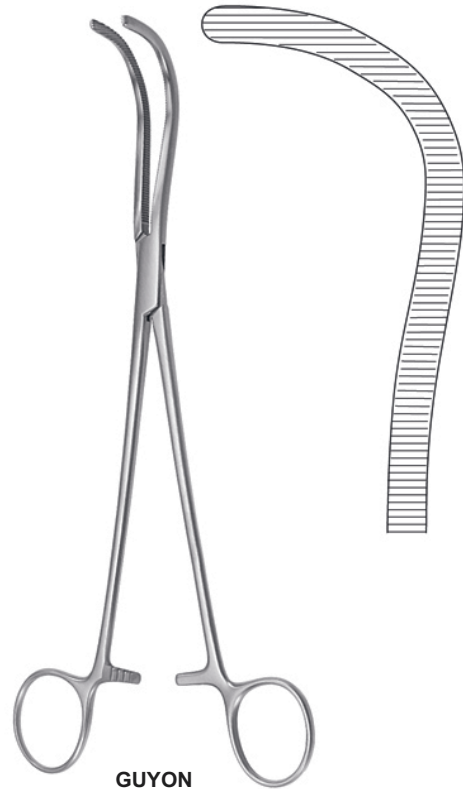

GUYON

23,0 cm, 9"
75-1677-23



GUYON

23,0 cm, 9"
75-1678-23

24,0 cm, 9¹/₂"
75-1679-24

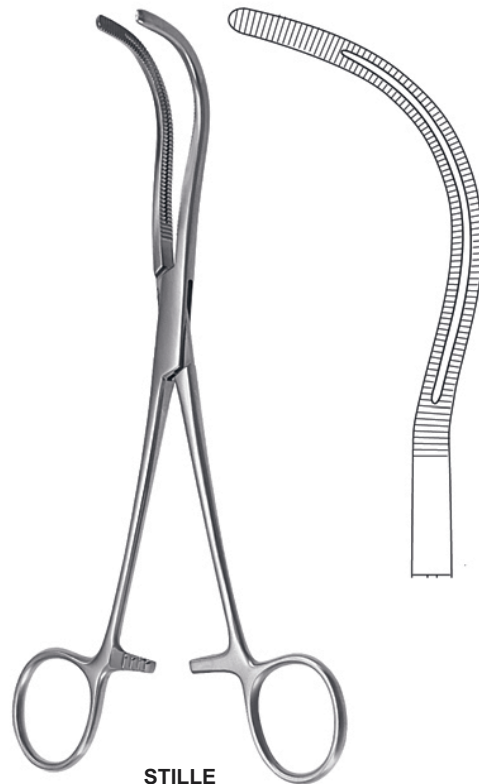

STILLE

23,0 cm, 9"
75-1680-23

Bronchusklemmen, Peritoneumklemmen, Hysterektomieklemmen
 Bronchus Forceps, Peritoneum Forceps, Hysterectomy Forceps
 Pinzas-clamps para bronquios, Pinzas-clamps para peritoneo y para histerectomía
 Pinze per legature, Pinze per peritoneo e per isterectomia



PRICE-THOMAS
 22,0 cm, 8³/₄"

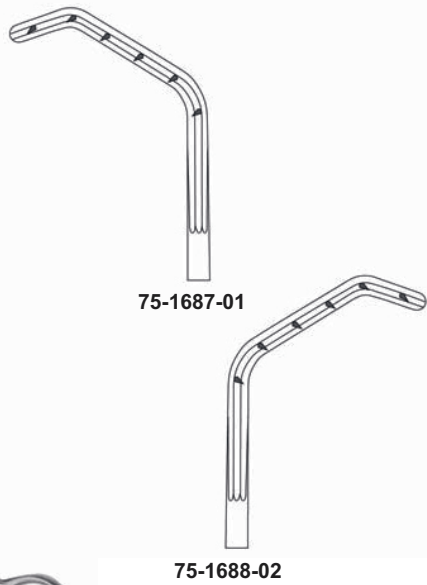

75-1687-01

75-1688-02



75-1689-01

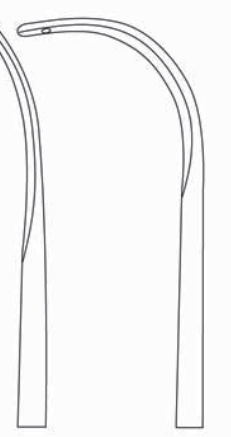

75-1690-02

24,0 cm, 9¹/₂"

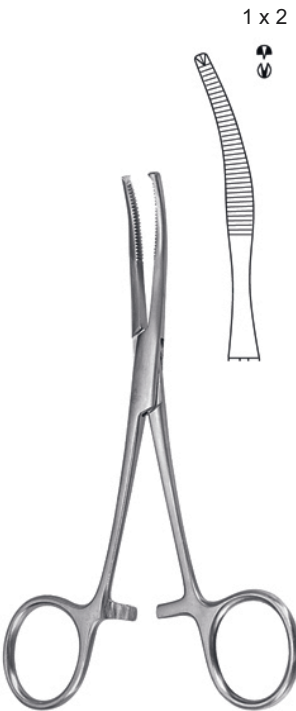

BABY-MIKULICZ
 14,0 cm, 5¹/₂"
 75-1691-14

1 x 2



MIKULICZ
 18,0 cm, 7"
 75-1692-18

1 x 2





MIKULICZ
 20,0 cm, 8"
 75-1693-20

1 x 2

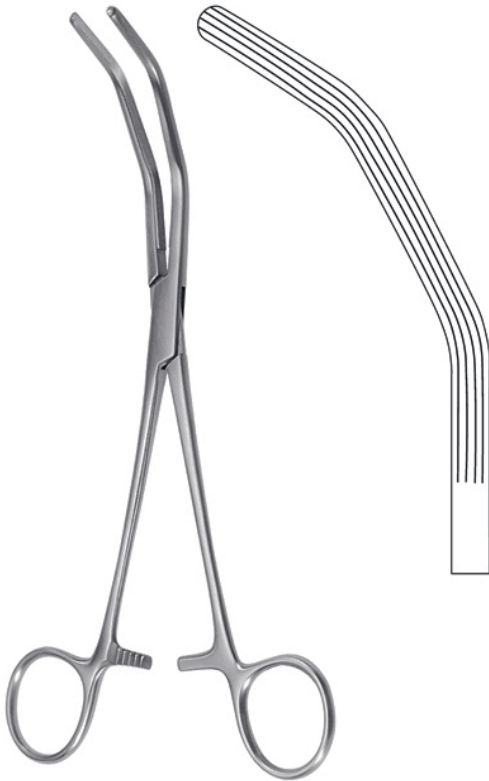

Gallenkanal- und Nierenstielklemmen, Bronchusklemmen
Gall Duct and Kidney Pedicle Clamps, Bronchus Forceps
Pinzas-clamps para pedúnculo renal, Pinzas-clamps para bronquios
Pinze per peduncoli renali, Pinze per legature

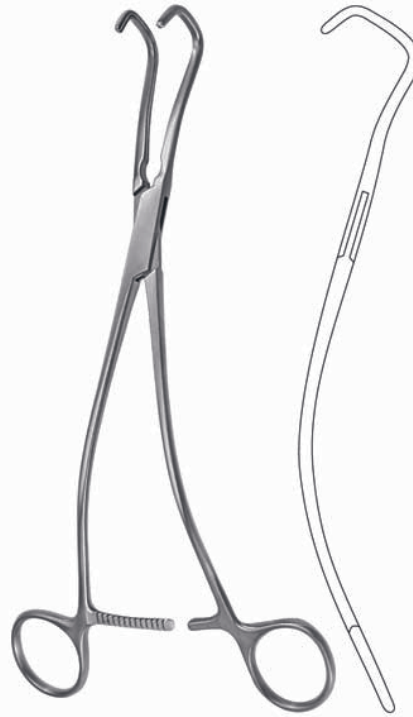

HERRICK
23,0 cm, 9"
75-1681-23

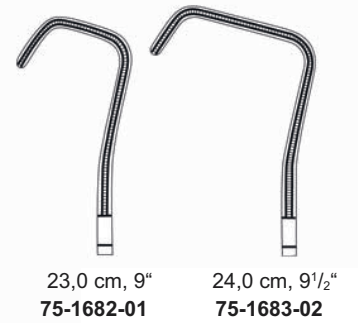

URO-TANGENTIAL
26,0 cm, 10¹/₄"



23,0 cm, 9"
75-1682-01

24,0 cm, 9¹/₂"
75-1683-02



LOVELACE
20,0 cm, 8"
75-1684-20



LOVELACE
20,0 cm, 8"
75-1685-20

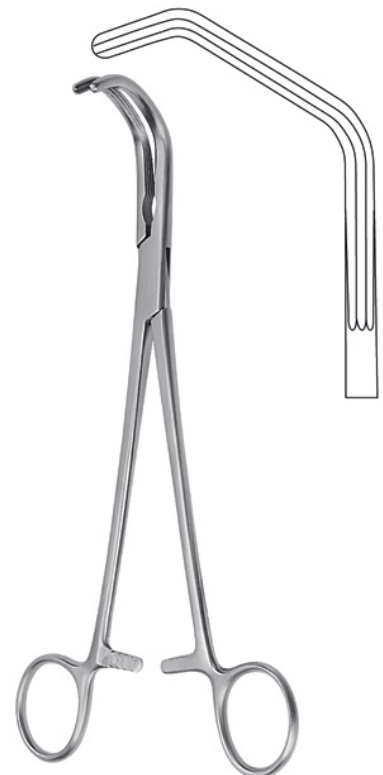

PRICE-THOMAS
22,0 cm, 8³/₄"
75-1686-22

Hysterektomieklemmen
 Hysterectomy Forceps
 Pinzas-clamps para histerectomia
 Pinze per isterectomia



WERTHEIM
 23,0 cm, 9"

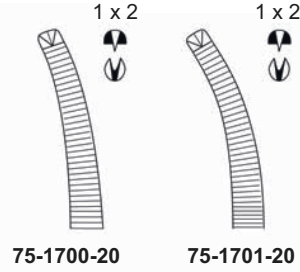

75-1700-20

75-1701-20

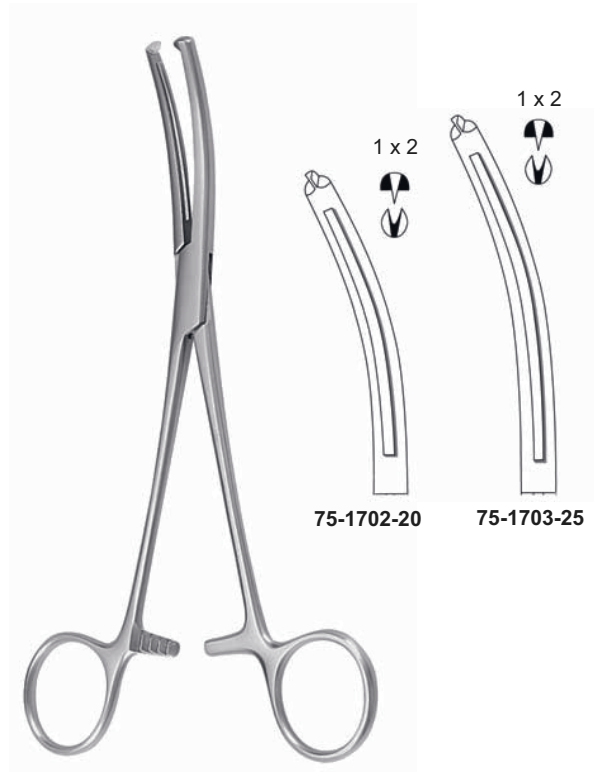

MAINGOT
 21,5 cm, 8 1/2"

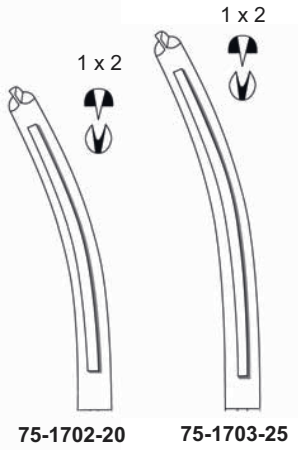

75-1702-20

75-1703-25

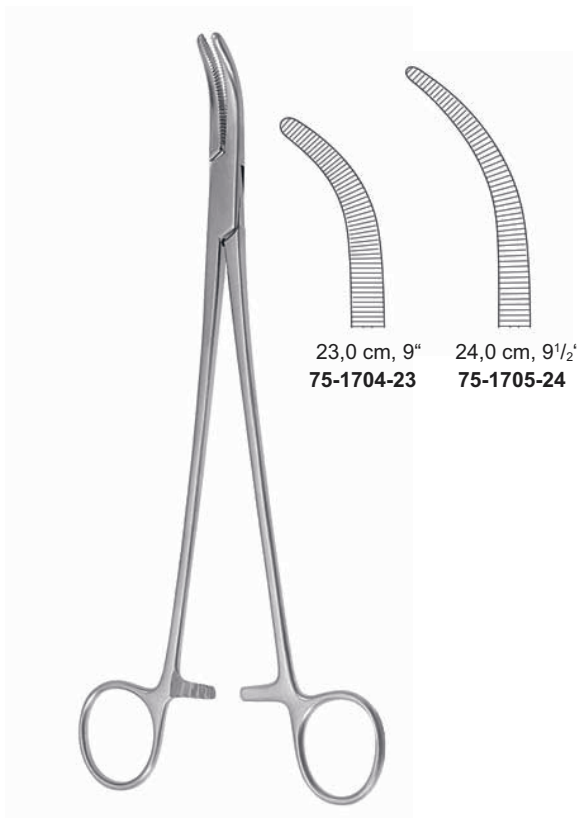

MOYNIHAN

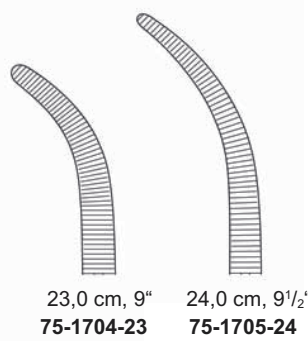

23,0 cm, 9"
 75-1704-23

24,0 cm, 9 1/2"
 75-1705-24



WERTHEIM-CULLEN
 21,5 cm, 8 1/2"
 75-1706-21

Peritoneumklemmen, Hysterektomieklemmen
Peritoneum Forceps, Hysterectomy Forceps
Pinzas-clamps para peritoneo y para histerectomía
Pinze per peritoneo e per isterectomia

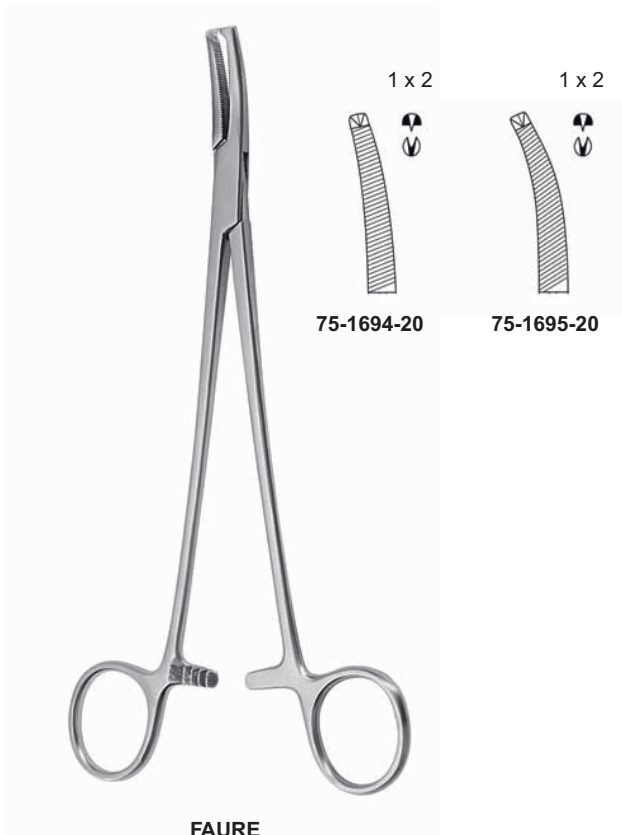

FAURE
20,0 cm, 8"

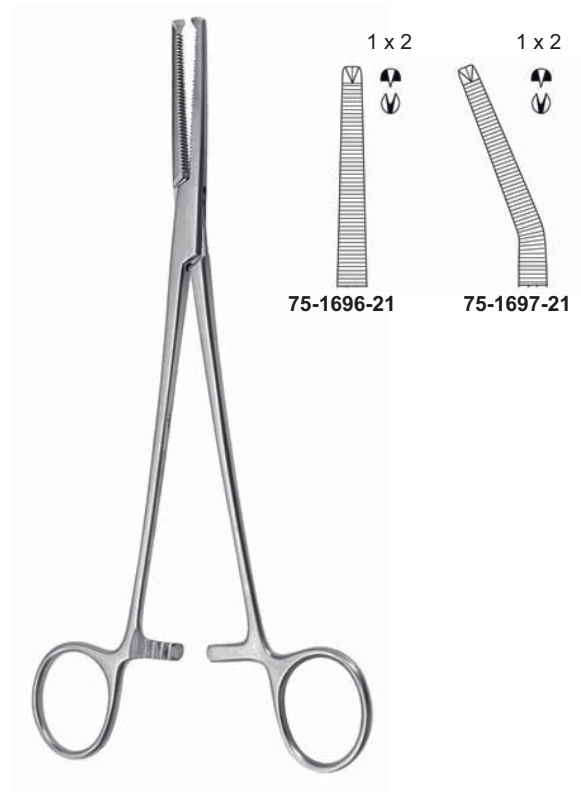

PHANEUF
21,5 cm, 8 1/2"

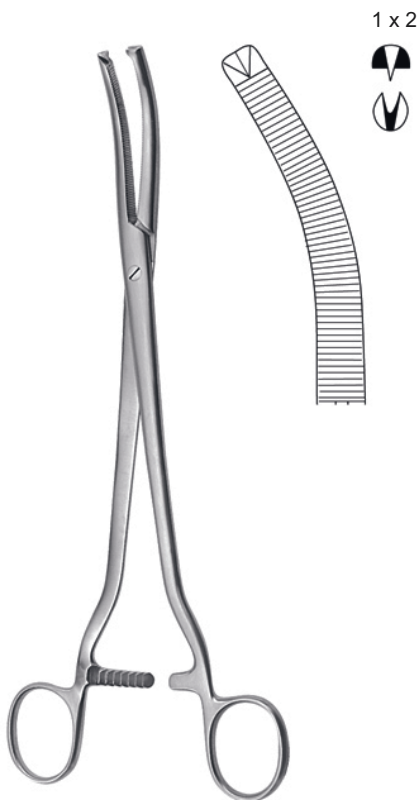

WERTHEIM
24,0 cm, 9 1/2"
75-1698-24



WERTHEIM
25,0 cm, 10"
75-1699-25

Hysterektomieklemmen
Hysterectomy Forceps
Pinzas-clamps para histerectomia
Pinze per isterectomia

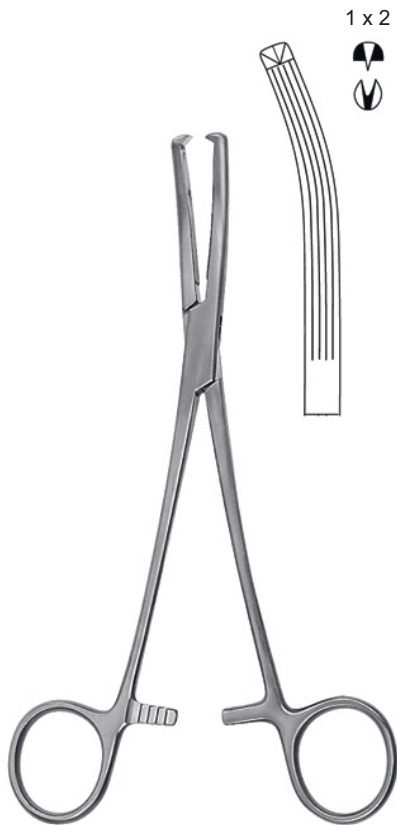

LONG
19,0 cm, 7¹/₄"
75-1707-19

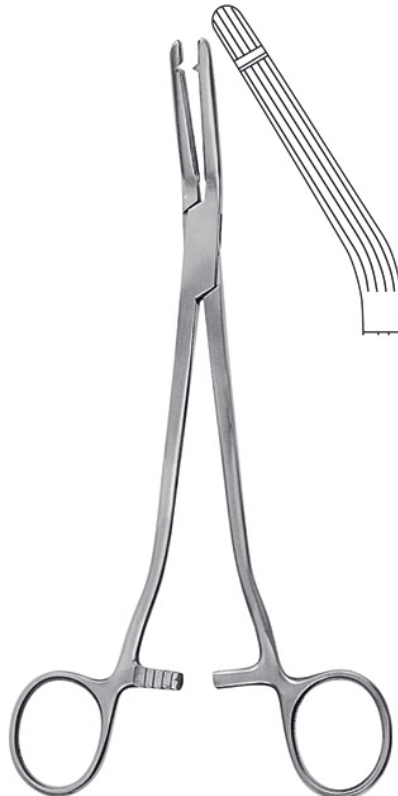

GARLAND
21,0 cm, 8¹/₄"
75-1708-21



HEANEY
21,0 cm, 8¹/₄"
75-1709-21

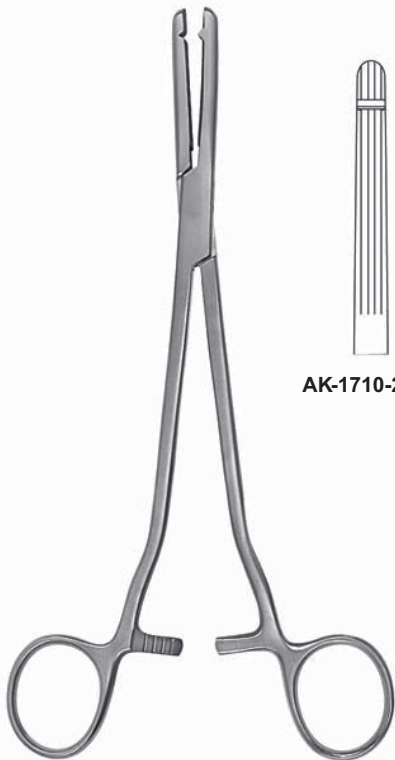

HEANEY-BALLANTINE
21,0 cm, 8¹/₄"

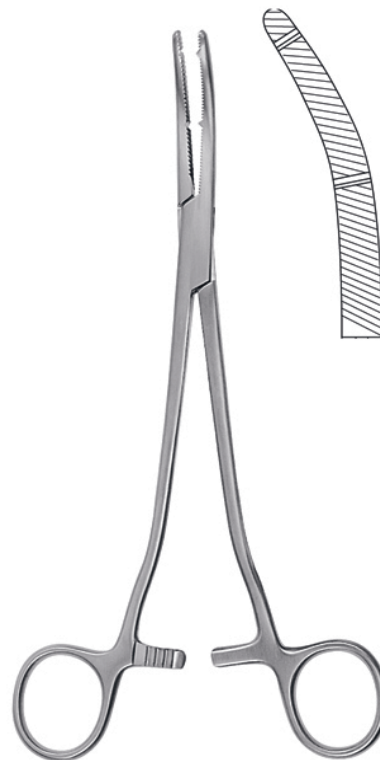
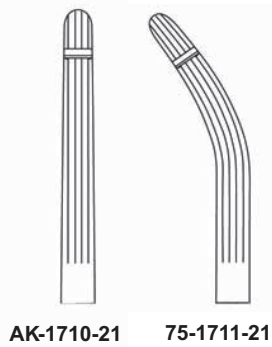

HEANEY-KANTER
21,0 cm, 8¹/₄"
75-1712-21

Hysterektomieklemmen
Hysterectomy Forceps
Pinzas-clamps para hysterectomia
Pinze per isterectomia

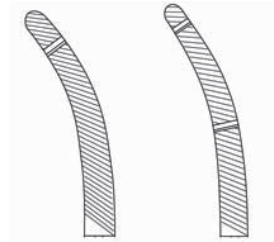

21,0 cm, 8¹/₄" 75-1713-21 75-1714-21
23,0 cm, 9" 75-1713-23 75-1714-23