

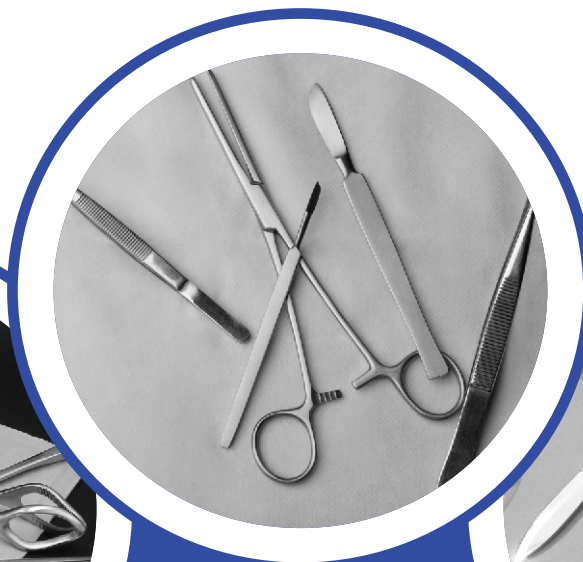

# 75 INDUSTRIES

CHOOSE US , TRUST US



## SURGICAL INSTRUMENTS CATALOGUE

# CONTENT PAGE



**75 INDUSTRIES**  
CHOOSE US, TRUST US

**C1**

04 to 14



Skalpellklingen, Skalpellgriffe, Messer  
Scalpel Blades, Scalpel Handles, Knives  
Hojas de bisturíes, Mangos de bisturíes, Cuchillos  
Lame per bisturi, Manici per bisturi, Coltelli

**C2**

14 to 62

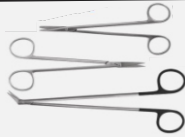

Scheren  
Scissors  
Tijeras  
Forbici

**C3**

63 to 83



Pinzetten  
Forceps  
Pinzas  
Pinze

**C4**

84 to 90

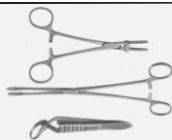

Tuch-, Schlauchklemmen, Tupferzangen  
Towel Clamps, Sponge and Dressing Forceps, Tubing Clamps  
Pinzas de campo, Pinzas para vendajes y torundas y para tubos  
Pinze per fissare le compresse, per medicatura e tamponi, e per tubi

**C5**

91 to 120

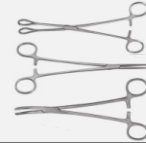

Klemmen  
Forceps  
Pinas  
Pinze

**C6**

121 to 153



Nahtinstrumente  
Suture Instruments  
Instrumentos para sutura  
strumenti per sutura

**C7**

154 to 183



Wundhaken  
Retrastors  
Separadores  
Divaricatori

**C8**

184 to 208



Wundspreizer  
Self-Retaining Retractors  
Separadores con retenida automática  
Divaricatori autostatici

# CONTENT PAGE

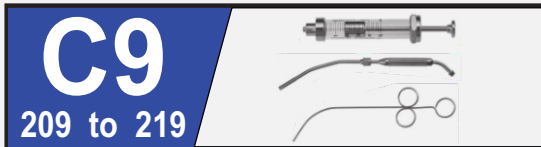

**Sonden, Trokare**  
**Probes, Trocars**  
**Sondas, Trócares**  
**Sonde, TrequaAKi**



**Galle, Leber, Niere, Blase, Urologie**  
**Gall, Liver, Kidney, Bladder, Urology**  
**Bilis, Hígado, Riñon, Vejiga, Urología**  
**Bile, Fegato, Rene, Vescica, Urologia**



**Magen, Darm, MaAKdarm**  
**AKomach, InteAKines, ReAKum**  
**EAKómagó, InteAKino, ReAKo**  
**AKomaco, InteAKino, Retto**



**Gynäkologie, GebuAAKhilfe**  
**Gynecology, ObAKetricis**  
**Ginecología, ObAKetricia**  
**Ginecologia, OAKetricia**



**Vorbereitung, Dermatologie**  
**Preparation, Dermatology**  
**Preparación, Dermatología**  
**Preparazione, Dermatologia**



**Knochenchirurgie**  
**Bone Surgery**  
**Cirurgía ósea**  
**Chirurgia ossea**



**AKerilisation**  
**AKerilization**  
**EAKerilización**  
**AKerilizzazione**

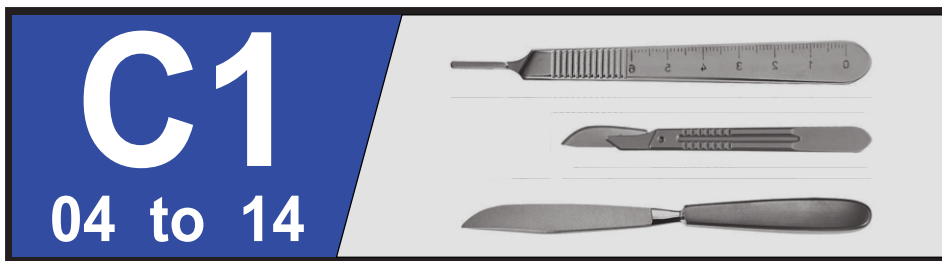

**Skalpellklingen, Skalpellgriffe, Messer**

**Scalpel Blades, Scalpel Handles, Knives**

**Hojas de bisturías, Mangos de bisturías, Cuchillos**

**Lame per bisturi, Manici per bisturi, Coltelli**

Sterile Skalpellklingen, Skalpellgriffe  
Sterile Scalpel Blades, Scalpel Handles  
Hojas de bisturíes estériles, Mangos de bisturíes  
Lame per bisturi sterili, Manici per bisturi



No. 3  
13,0 cm, 5"  
75-1003-03



No. 3  
13,0 cm, 5"  
75-1003-04



No. 3L  
21,0 cm, 8¼"  
75-1003-05



No. 7  
16,5 cm, 6½"  
75-1007-06

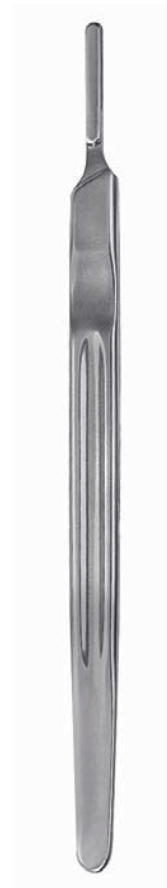

No. 7K  
13,0 cm, 5"  
75-1007-07

Sterile Skalpellklingen, Skalpellgriffe  
Sterile Scalpel Blades, Scalpel Handles  
Hojas de bisturíes estériles, Mangos de bisturíes  
Lame per bisturi sterili, Manici per bisturi



No. 4  
13,5 cm, 5<sup>3</sup>/<sub>8</sub>"  
75-1004-04



No. 4L  
21,0 cm, 8<sup>3</sup>/<sub>8</sub>"  
75-1004-04L



No. 8  
13,5 cm, 5<sup>3</sup>/<sub>8</sub>"  
75-1004-08



No. 9  
14,5 cm, 5<sup>3</sup>/<sub>4</sub>"  
75-1004-09

Einmal-Skalpelle, steril  
Disposable Scalpels, sterile  
Bisturíes para uso único, estériles  
Bisturi monouso, sterili



Fig. 10  
75-1005-10



Fig. 11  
75-1005-11



Fig. 11s  
75-1005-11S



Fig. 12  
75-1005-12



Fig. 12d  
75-1005-12D



Fig. 13  
75-1005-13



Fig. 15  
75-1005-15



Fig. 15c  
75-1005-15C

Einmal-Skalpelle, steril  
Disposable Scalpels, sterile  
Bisturíes para uso único, estériles  
Bisturi monouso, sterili



Fig. 18  
75-1005-18



Fig. 19  
75-1005-19



Fig. 20  
75-1005-20

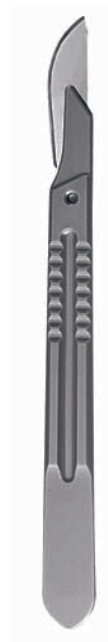

Fig. 21  
75-1005-21



Fig. 22  
75-1005-22



Fig. 23  
75-1005-23



Fig. 24  
75-1005-24

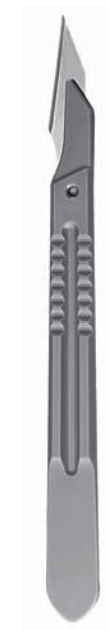

Fig. 25  
75-1005-25



Skalpelle  
Knives  
Bisturies  
Bisturi



Fig. 1 **75-1006-01**  
Fig. 2 **75-1006-02**  
Fig. 3 **75-1006-03**



**OPERATION**  
17,0 cm, 6¾"



Fig. 10 **75-1006-10**  
Fig. 12 **75-1006-12**  
Fig. 14 **75-1006-14**  
Fig. 16 **75-1006-16**  
Fig. 18 **75-1006-18**



**COLLIN**  
16,0 cm, 6¼"



Fig. 4 **75-1006-04**  
Fig. 5 **75-1006-05**  
Fig. 6 **75-1006-06**

Skalpelle  
Knives  
Bisturies  
Bisturi



Fig. 1 **75-1007-01**  
Fig. 2 **75-1007-02**  
Fig. 3 **75-1007-03**  
Fig. 4 **75-1007-04**  
Fig. 5 **75-1007-05**



Fig. 1 **75-1008-01**  
Fig. 2 **75-1008-02**  
Fig. 3 **75-1008-03**  
Fig. 4 **75-1008-04**  
Fig. 5 **75-1008-05**



Fig. 15 **75-1008-15**



**DISSECTING**  
17,0 cm, 6¾"



Fig. 6 **75-1007-06**  
Fig. 7 **75-1007-07**  
Fig. 8 **75-1007-08**  
Fig. 9 **75-1007-09**  
Fig. 10 **75-1007-10**



**DIEFENBACH**  
16,0 cm, 6¼"

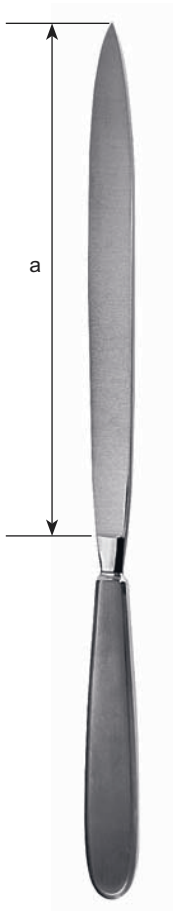

Fig. 6 **75-1008-06**  
Fig. 7 **75-1008-07**  
Fig. 8 **75-1008-08**  
Fig. 9 **75-1008-09**



Fig. 16 **75-1008-16**

Amputationsmesser  
Amputation Knives  
Cuchillos para amputación  
Coltelli per amputazione



**COLLIN**

a	
13,0 cm, 5"	<b>75-1008-13</b>
16,0 cm, 6 <sup>1</sup> / <sub>4</sub> "	<b>75-1008-16</b>
19,0 cm, 7 <sup>1</sup> / <sub>2</sub> "	<b>75-1008-19</b>
22,0 cm, 8 <sup>5</sup> / <sub>8</sub> "	<b>75-1008-22</b>
28,0 cm, 11"	<b>75-1008-28</b>

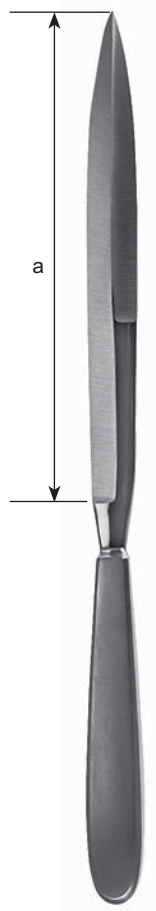

**CATLIN**

A	
16,0 cm, 6 <sup>1</sup> / <sub>4</sub> "	<b>75-1009-16</b>
19,0 cm, 7 <sup>1</sup> / <sub>2</sub> "	<b>75-1009-19</b>
22,0 cm, 8 <sup>5</sup> / <sub>8</sub> "	<b>75-1009-22</b>

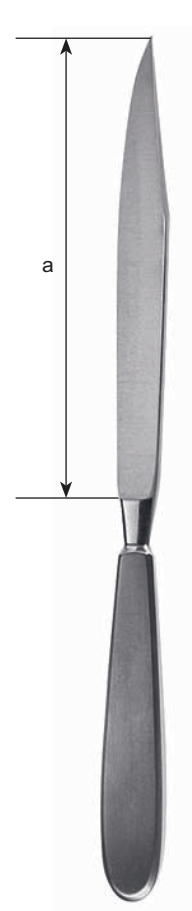

**LISTON**

A	
17,0 cm, 6 <sup>3</sup> / <sub>4</sub> "	<b>75-1009-17</b>
20,0 cm, 8"	<b>75-1009-20</b>
22,0 cm, 8 <sup>5</sup> / <sub>8</sub> "	<b>75-1009-22</b>

Amputationsmesser, Messer für Autopsie  
Amputation Knives, Post Mortem Knives  
Cuchillos para amputación, Cuchillos para autopsia  
Coltelli per amputazione, Coltelli per autopsia

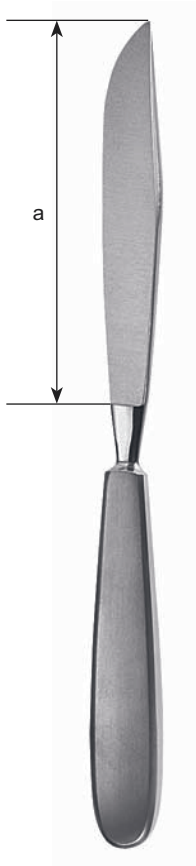

**LANGENBECK**  
75-1010-16

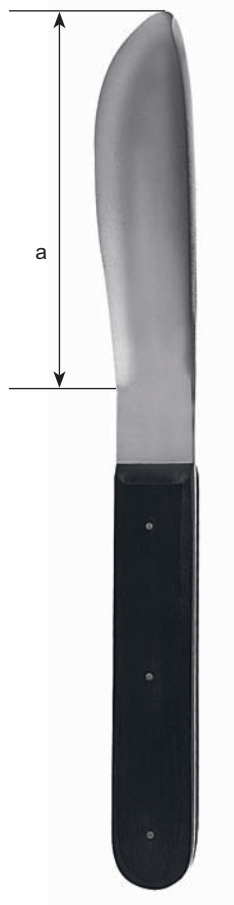

**WALB**

A	
11,0 cm, 4 1/2"	<b>75-1010-11</b>
14,0 cm, 5 1/2"	<b>75-1010-14</b>
17,0 cm, 6 3/4"	<b>75-1010-17</b>

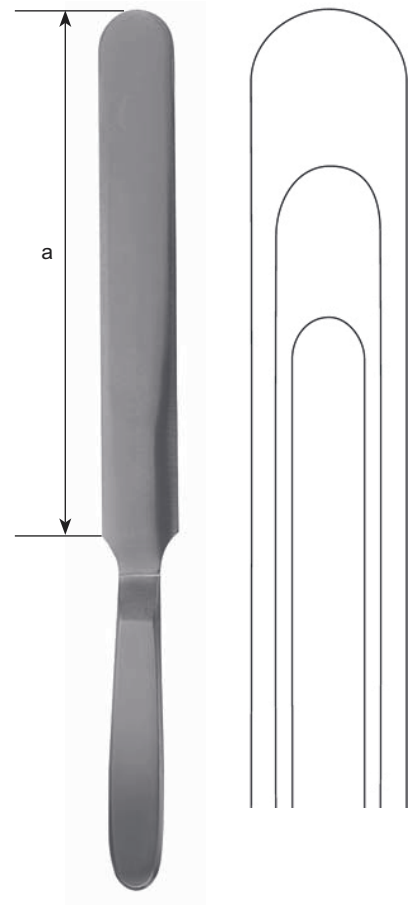

**VIRCHOW**

A	
16,0 cm, 6 1/4"	<b>75-1011-16</b>
20,0 cm, 8"	<b>75-1011-20</b>
24,0 cm, 9 1/2"	<b>75-1011-24</b>

# Surgical Catalogue

Amputationsmesser, Dermatome  
 Amputation Knives, Dermatomes  
 Cuchillos para amputación, Dermátomos  
 Coltelli per amputazione, Dermatomi



**LANGENBECK**  
 18,0 cm, 7"  
 75-1011-55



mit Schaber  
 with raspatory  
 con periostótomo  
 con raschiatoio

**CARTILAGE**  
 17,5 cm, 6<sup>5</sup>/<sub>8</sub>"  
 75-1011-65

Haut-Spannplatten  
 Skin straightening plate  
 Placa para extender la piel  
 Placca per stendere la pelle



**75-1011-30**

Resektionsmesser  
Resection Knives  
Cuchillos para resección  
Coltelli per resezione



**SILVER**  
19 cm, 7½"  
75-1013-19



**BRAITHWAITE**  
30,0 cm, 12"  
75-1013-30



**HUMBY**  
35,0 cm, 14"  
75-1013-35



**SCHINK**  
30,0 cm, 12"  
75-1013-30



**Scheren**

**Scissors**

**Tijeras**

**Forbici**

Chirurgische Scheren  
Surgical Scissors  
Tijeras para cirugía  
Forbici per chirurgia



STANDARD	
10,5 cm, 4 <sup>1</sup> / <sub>4</sub> "	75-1014-10
11,5 cm, 4 <sup>1</sup> / <sub>2</sub> "	75-1014-11
13,0 cm, 5"	75-1014-13
14,5 cm, 5 <sup>3</sup> / <sub>4</sub> "	75-1014-14
15,5 cm, 6"	75-1014-15
16,5 cm, 6 <sup>1</sup> / <sub>2</sub> "	75-1014-16
17,5 cm, 6 <sup>5</sup> / <sub>8</sub> "	75-1014-17
18,5 cm, 7 <sup>1</sup> / <sub>4</sub> "	75-1014-18
20,0 cm, 8"	75-1014-20

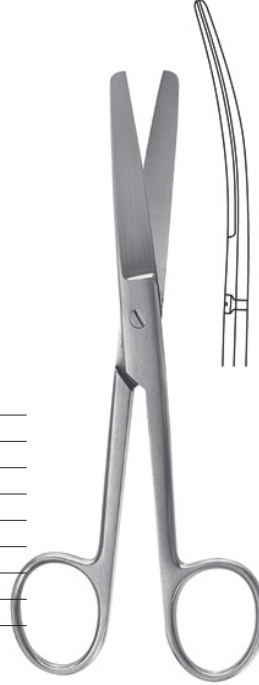

STANDARD	
10,5 cm, 4 <sup>1</sup> / <sub>4</sub> "	75-1015-10
11,5 cm, 4 <sup>1</sup> / <sub>2</sub> "	75-1015-11
13,0 cm, 5"	75-1015-13
14,5 cm, 5 <sup>3</sup> / <sub>4</sub> "	75-1015-14
15,5 cm, 6"	75-1015-15
16,5 cm, 6 <sup>1</sup> / <sub>2</sub> "	75-1015-16
17,5 cm, 6 <sup>5</sup> / <sub>8</sub> "	75-1015-17
18,5 cm, 7 <sup>1</sup> / <sub>4</sub> "	75-1015-18
20,0 cm, 8"	75-1015-20



STANDARD	
10,5 cm, 4 <sup>1</sup> / <sub>4</sub> "	75-1016-10
11,5 cm, 4 <sup>1</sup> / <sub>2</sub> "	75-1016-11
13,0 cm, 5"	75-1016-13
14,5 cm, 5 <sup>3</sup> / <sub>4</sub> "	75-1016-14
15,5 cm, 6"	75-1016-15
16,5 cm, 6 <sup>1</sup> / <sub>2</sub> "	75-1016-16
17,5 cm, 6 <sup>5</sup> / <sub>8</sub> "	75-1016-17
18,5 cm, 7 <sup>1</sup> / <sub>4</sub> "	75-1016-18
20,0 cm, 8"	75-1016-20

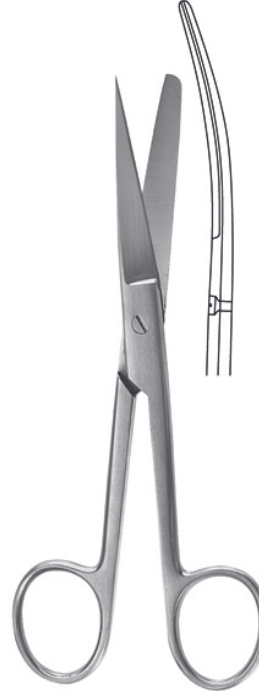

STANDARD	
10,5 cm, 4 <sup>1</sup> / <sub>4</sub> "	75-1017-10
11,5 cm, 4 <sup>1</sup> / <sub>2</sub> "	75-1017-11
13,0 cm, 5"	75-1017-13
14,5 cm, 5 <sup>3</sup> / <sub>4</sub> "	75-1017-14
15,5 cm, 6"	75-1017-15
16,5 cm, 6 <sup>1</sup> / <sub>2</sub> "	75-1017-16
17,5 cm, 6 <sup>5</sup> / <sub>8</sub> "	75-1017-17
18,5 cm, 7 <sup>1</sup> / <sub>4</sub> "	75-1017-18
20,0 cm, 8"	75-1017-20



Chirurgische Scheren, Präparierscheren  
Surgical Scissors, Dissecting Scissors  
Tijeras para cirugía, Tijeras de disección  
Forbici per chirurgia, Forbici per dissezione



**STANDARD**

10,5 cm, 4 <sup>1</sup> / <sub>4</sub> "	<b>75-1018-10</b>
11,5 cm, 4 <sup>1</sup> / <sub>2</sub> "	<b>75-1018-11</b>
13,0 cm, 5"	<b>75-1018-13</b>
14,5 cm, 5 <sup>3</sup> / <sub>4</sub> "	<b>75-1018-14</b>
15,5 cm, 6"	<b>75-1018-15</b>
16,5 cm, 6 <sup>1</sup> / <sub>2</sub> "	<b>75-1018-16</b>
17,5 cm, 6 <sup>5</sup> / <sub>8</sub> "	<b>75-1018-17</b>
18,5 cm, 7 <sup>1</sup> / <sub>4</sub> "	<b>75-1018-18</b>
20,0 cm, 8"	<b>75-1018-20</b>



**STANDARD**

10,5 cm, 4 <sup>1</sup> / <sub>4</sub> "	<b>75-1020-10</b>
11,5 cm, 4 <sup>1</sup> / <sub>2</sub> "	<b>75-1020-11</b>
13,0 cm, 5"	<b>75-1020-13</b>
14,5 cm, 5 <sup>3</sup> / <sub>4</sub> "	<b>75-1020-14</b>
15,5 cm, 6"	<b>75-1020-15</b>
16,5 cm, 6 <sup>1</sup> / <sub>2</sub> "	<b>75-1020-16</b>
17,5 cm, 6 <sup>5</sup> / <sub>8</sub> "	<b>75-1020-17</b>
18,5 cm, 7 <sup>1</sup> / <sub>4</sub> "	<b>75-1020-18</b>
20,0 cm, 8"	<b>75-1020-20</b>



**DEAVER**

12,0 cm, 4 <sup>3</sup> / <sub>4</sub> "	<b>75-1021-12</b>
13,0 cm, 5"	<b>75-1021-13</b>
14,5 cm, 5 <sup>3</sup> / <sub>4</sub> "	<b>75-1021-14</b>



**DEAVER**

12,0 cm, 4 <sup>3</sup> / <sub>4</sub> "	<b>75-1022-12</b>
13,0 cm, 5"	<b>75-1022-13</b>
14,5 cm, 5 <sup>3</sup> / <sub>4</sub> "	<b>75-1022-14</b>

**Präparierscheren  
Dissecting Scissors  
Tijeras de disección**



**DEAVER**

12,0 cm, 4 <sup>3</sup> / <sub>4</sub> "	<b>75-1023-12</b>
13,0 cm, 5"	<b>75-1023-13</b>
14,5 cm, 5 <sup>3</sup> / <sub>4</sub> "	<b>75-1023-14</b>

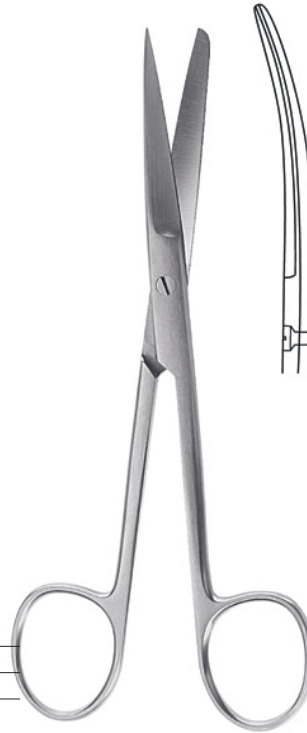

**DEAVER**

12,0 cm, 4 <sup>3</sup> / <sub>4</sub> "	<b>75-1024-12</b>
13,0 cm, 5"	<b>75-1024-13</b>
14,5 cm, 5 <sup>3</sup> / <sub>4</sub> "	<b>75-1024-14</b>



**DEAVER**

12,0 cm, 4 <sup>3</sup> / <sub>4</sub> "	<b>75-1025-12</b>
13,0 cm, 5"	<b>75-1025-13</b>
14,5 cm, 5 <sup>3</sup> / <sub>4</sub> "	<b>75-1025-14</b>

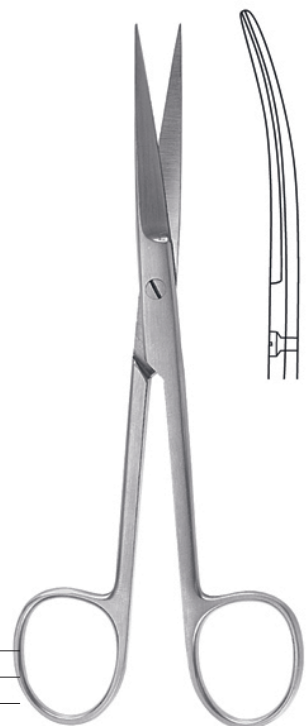

**DEAVER**

12,0 cm, 4 <sup>3</sup> / <sub>4</sub> "	<b>75-1026-12</b>
13,0 cm, 5"	<b>75-1026-13</b>
14,5 cm, 5 <sup>3</sup> / <sub>4</sub> "	<b>75-1026-14</b>

Präparierscheren  
Dissecting Scissors  
Tijeras de disección  
Forbici per dissezione



**GRAZIL**  
13,0 cm, 5" **75-1027-13**  
14,5 cm, 5<sup>3</sup>/<sub>4</sub>" **75-1027-14**



**GRAZIL**  
13,0 cm, 5" **75-1028-13**  
14,5 cm, 5<sup>3</sup>/<sub>4</sub>" **75-1028-14**



**GRAZIL**  
13,0 cm, 5" **75-1029-13**  
14,5 cm, 5<sup>3</sup>/<sub>4</sub>" **75-1029-14**



**GRAZIL**  
13,0 cm, 5" **75-1030-13**  
14,5 cm, 5<sup>3</sup>/<sub>4</sub>" **75-1030-14**

**Präparierscheren**  
**Dissecting Scissors**  
**Tijeras de disección**  
**Forbici per dissezione**



**GRAZIL**

13,0 cm, 5"	<b>75-1031-13</b>
14,5 cm, 5 <sup>3</sup> / <sub>4</sub> "	<b>75-1031-14</b>



**GRAZIL**

13,0 cm, 5"	<b>75-1032-13</b>
14,5 cm, 5 <sup>3</sup> / <sub>4</sub> "	<b>75-1032-14</b>

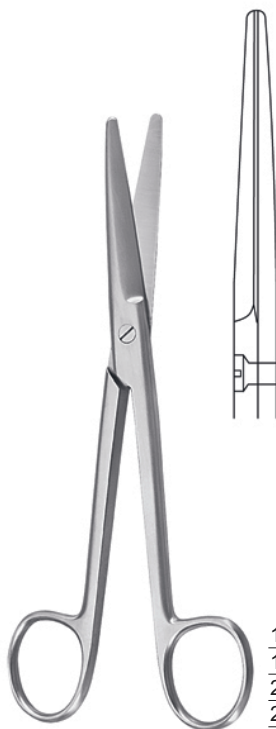

**MAYO**

14,5 cm, 5 <sup>3</sup> / <sub>4</sub> "	<b>75-1033-14</b>
17,0 cm, 6 <sup>3</sup> / <sub>4</sub> "	<b>75-1033-17</b>
23,0 cm, 9"	<b>75-1033-23</b>
28,0 cm, 11"	<b>75-1033-28</b>

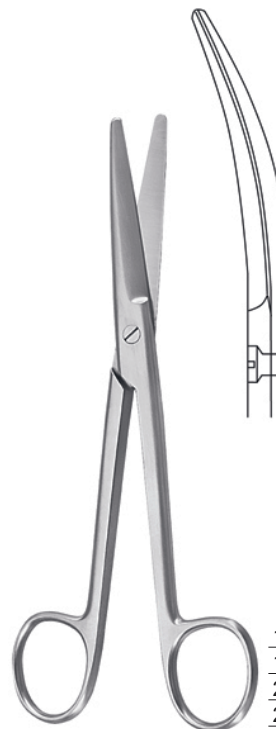

**MAYO**

14,5 cm, 5 <sup>3</sup> / <sub>4</sub> "	<b>75-1034-14</b>
17,0 cm, 6 <sup>3</sup> / <sub>4</sub> "	<b>75-1034-17</b>
23,0 cm, 9"	<b>75-1034-23</b>
28,0 cm, 11"	<b>75-1034-28</b>

Präparierscheren  
Dissecting Scissors  
Tijeras de disección  
Forbici per dissezione

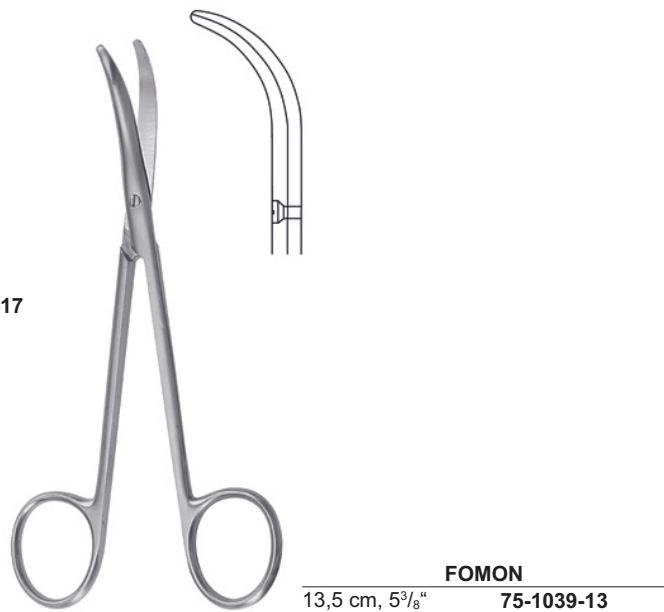
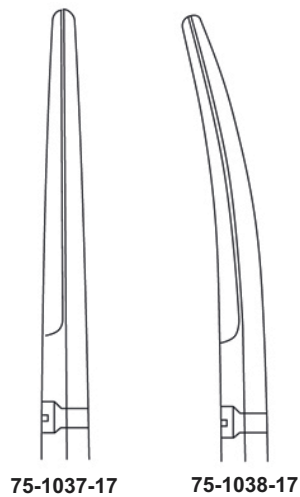

Präparierscheren  
Dissecting Scissors  
Tijeras de disección  
Forbici per dissezione

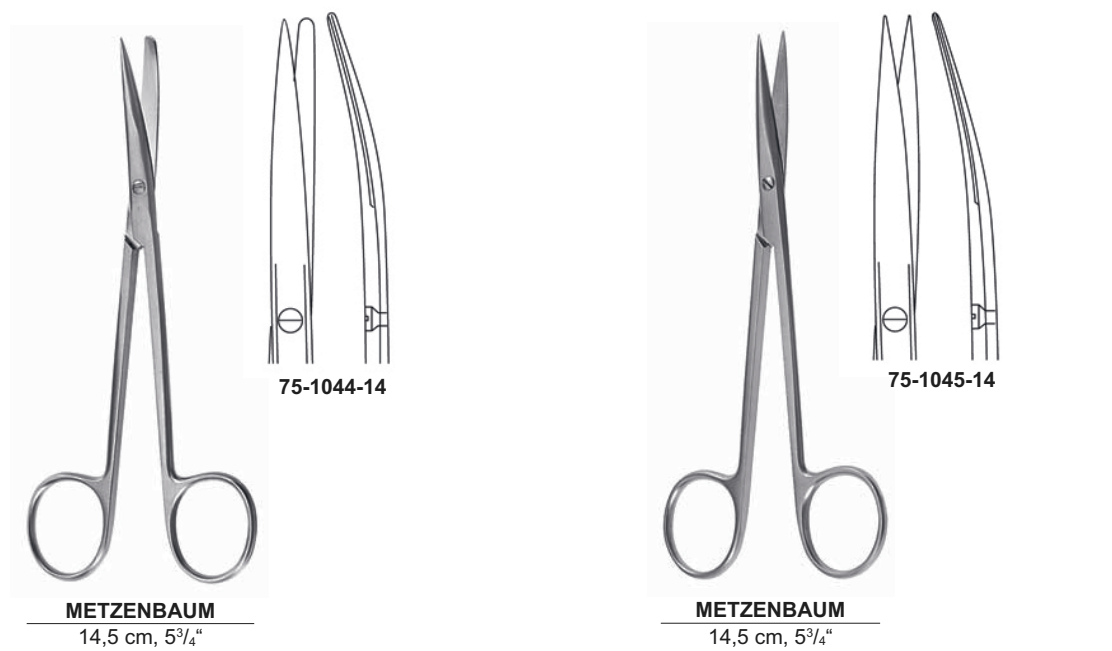
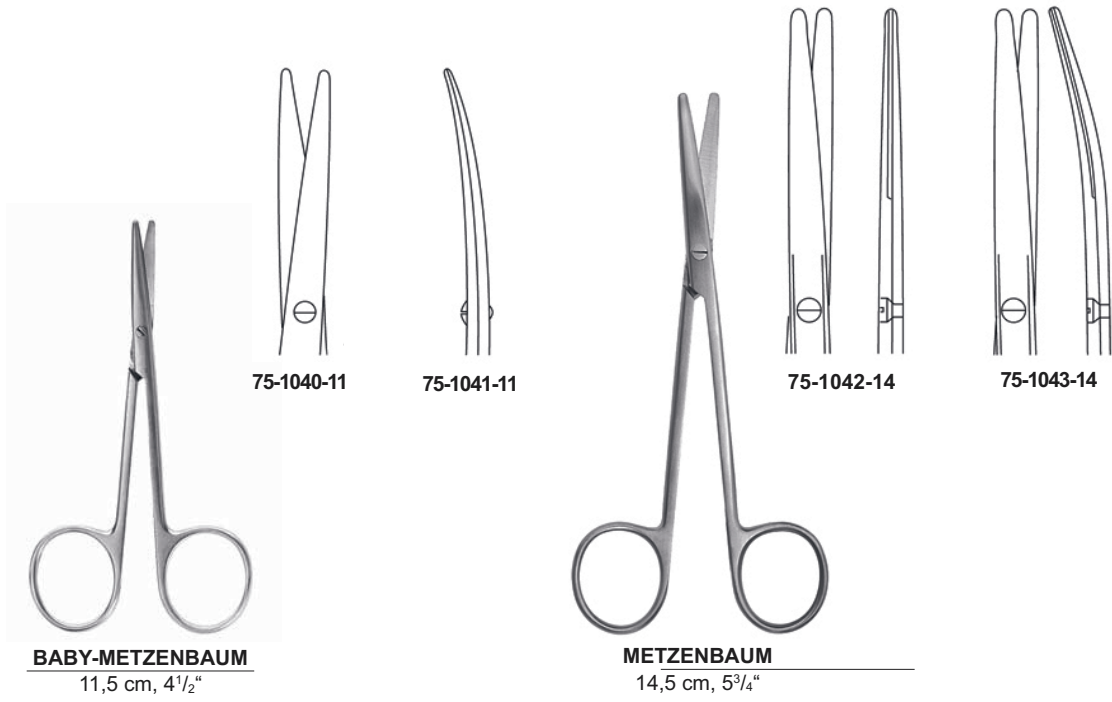

Präparierscheren  
Dissecting Scissors  
Tijeras de disección  
Forbici per dissezione



**METZENBAUM**

18,0 cm, 7"	<b>75-1046-18</b>
20,0 cm, 8"	<b>75-1046-20</b>
23,0 cm, 9"	<b>75-1046-23</b>
25,0 cm, 10"	<b>75-1046-25</b>
28,0 cm, 11"	<b>75-1046-28</b>
30,0 cm, 12"	<b>75-1046-30</b>



**METZENBAUM**

18,0 cm, 7"	<b>75-1047-18</b>
20,0 cm, 8"	<b>75-1047-20</b>
23,0 cm, 9"	<b>75-1047-23</b>
25,0 cm, 10"	<b>75-1047-25</b>
28,0 cm, 11"	<b>75-1047-28</b>
30,0 cm, 12"	<b>75-1047-30</b>



**METZENBAUM**

18,0 cm, 7"	<b>75-1048-18</b>
20,0 cm, 8"	<b>75-1048-20</b>
23,0 cm, 9"	<b>75-1048-23</b>
25,0 cm, 10"	<b>75-1048-25</b>
28,0 cm, 11"	<b>75-1048-28</b>
30,0 cm, 12"	<b>75-1048-30</b>



**METZENBAUM**

18,0 cm, 7"	<b>75-1049-18</b>
20,0 cm, 8"	<b>75-1049-20</b>
23,0 cm, 9"	<b>75-1049-23</b>
25,0 cm, 10"	<b>75-1049-25</b>
28,0 cm, 11"	<b>75-1049-28</b>
30,0 cm, 12"	<b>75-1049-30</b>

**Präparierscheren**  
**Dissecting Scissors**  
**Tijeras de disección**  
**Forbici per dissezione**

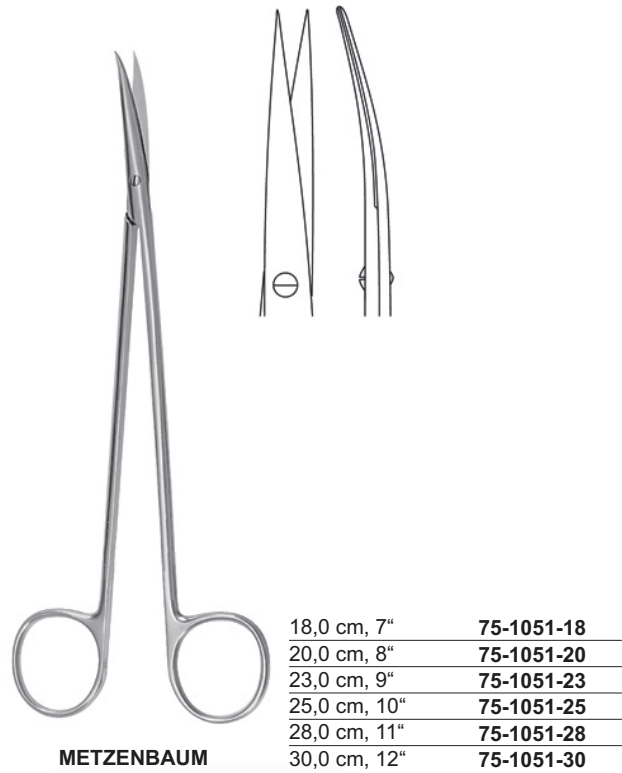
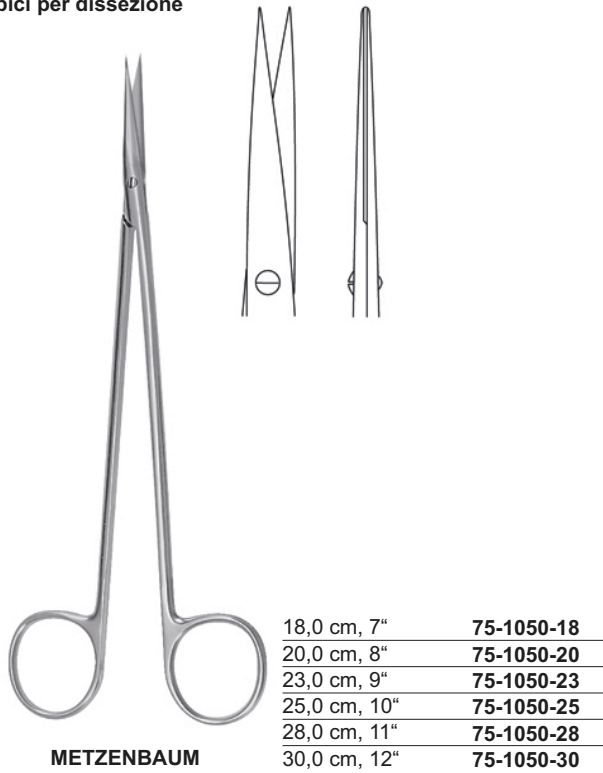



Präparierscheren  
Dissecting Scissors  
Tijeras de disección  
Forbici per dissezione

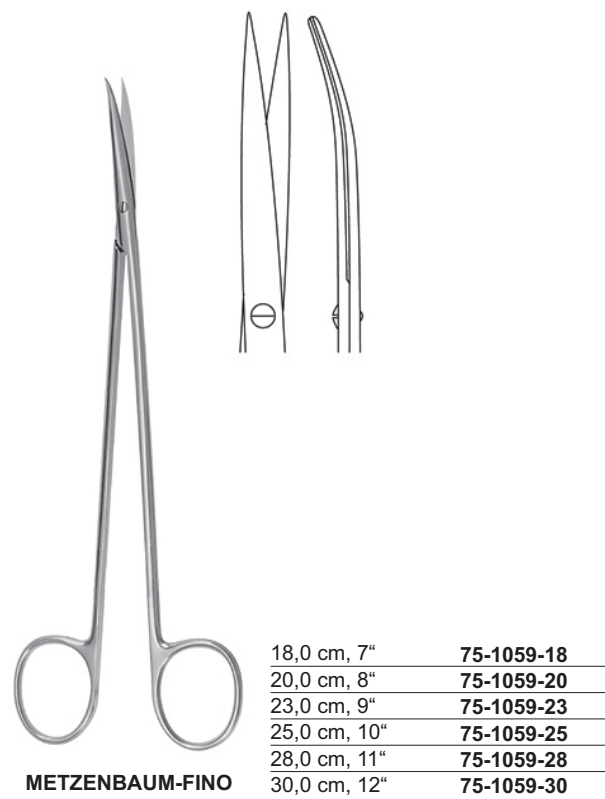
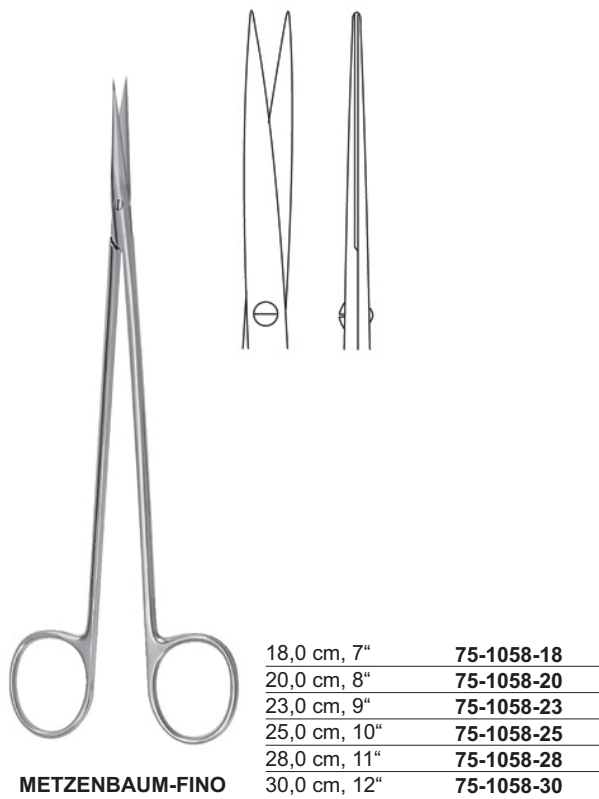
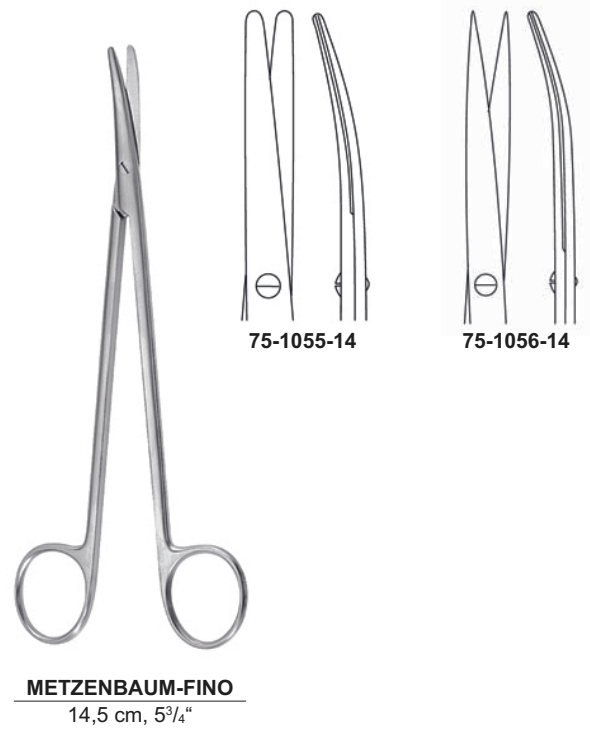
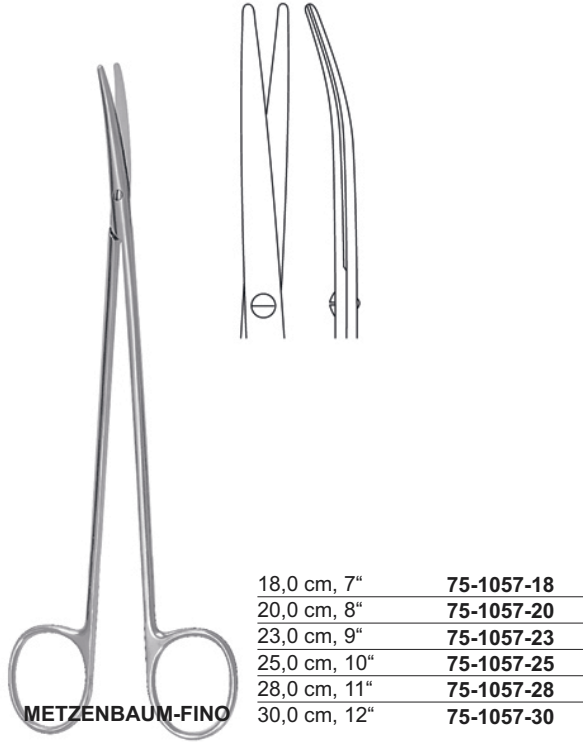

**Präparierscheren**  
**Dissecting Scissors**  
**Tijeras de disección**  
**Forbici per dissezione**

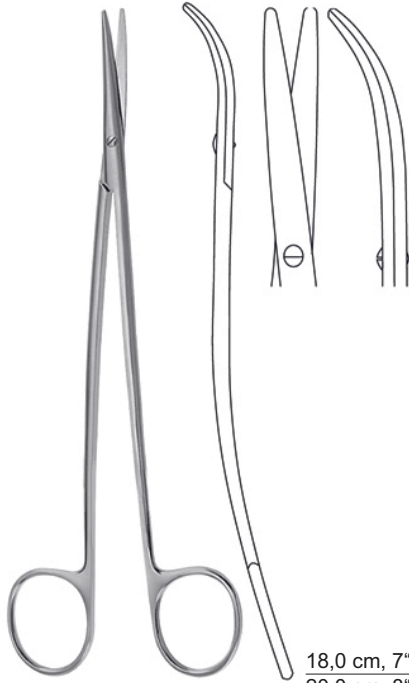

**METZENBAUM-FINO S**

18,0 cm, 7"	<b>75-1060-18</b>
20,0 cm, 8"	<b>75-1060-20</b>
23,0 cm, 9"	<b>AK-1060-23</b>

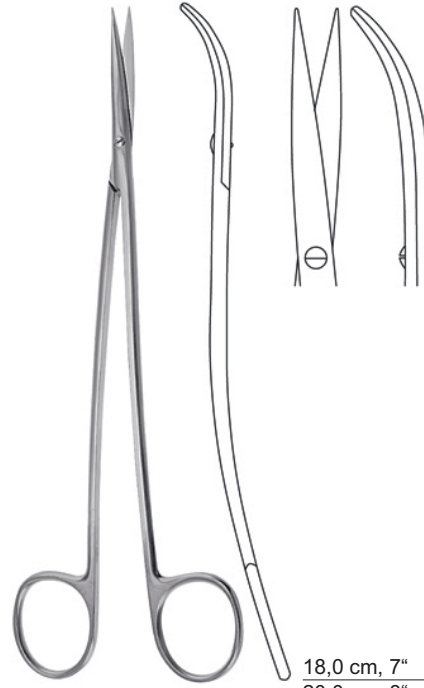

**METZENBAUM-FINOS**

18,0 cm, 7"	<b>75-1061-18</b>
20,0 cm, 8"	<b>75-1061-20</b>
23,0 cm, 9"	<b>75-1061-23</b>



**METZENBAUM-LAHEY**

14,0 cm, 5 1/2"	<b>75-1062-14</b>
-----------------	-------------------



**TOENNIS-ADSON**

17,0 cm, 6 3/4"	<b>75-1063-17</b>
-----------------	-------------------

Präparierscheren  
Dissecting Scissors  
Tijeras de disección  
Forbici per dissezione



**BABY-LEXER**  
10,0 cm, 4"



**LEXER**      16,0 cm, 6<sup>1</sup>/<sub>4</sub>"      **75-1066-16**  
21,0 cm, 8<sup>1</sup>/<sub>4</sub>"      **75-1066-21**



**LEXER**      16,0 cm, 6<sup>1</sup>/<sub>4</sub>"      **75-1069-16**  
21,0 cm, 8<sup>1</sup>/<sub>4</sub>"      **75-1069-21**

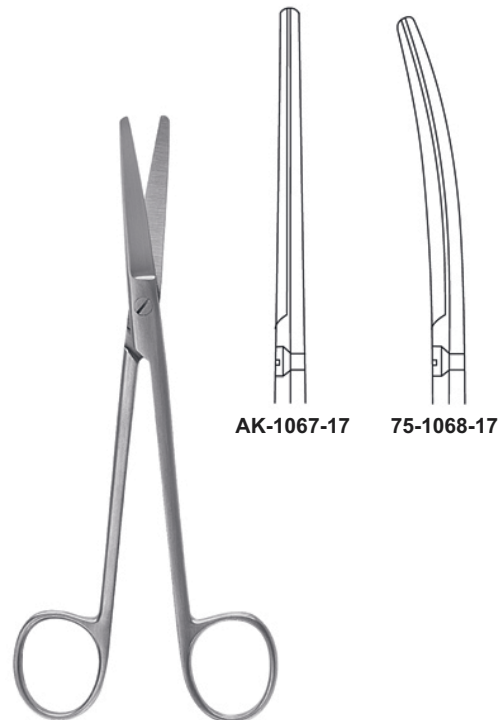

**MIXTER**  
17,0 cm, 6<sup>3</sup>/<sub>4</sub>"

Präparierscheren, feine chirurgische Scheren  
 Dissecting Scissors, fine surgical scissors  
 Tijeras de disección, tijeras finas para cirugía  
 Forbici per dissezione, forbici fine per chirurgia



**KILNER (RAGNELL)**

12,0 cm, 4 <sup>3</sup> / <sub>4</sub> "	<b>75-1070-12</b>
15,0 cm, 6"	<b>75-1070-15</b>
18,0 cm, 7"	<b>75-1070-18</b>
20,0 cm, 8"	<b>75-1070-20</b>



**KILNER (RAGNELL)**

12,0 cm, 4 <sup>3</sup> / <sub>4</sub> "	<b>75-1071-12</b>
15,0 cm, 6"	<b>75-1071-15</b>
18,0 cm, 7"	<b>75-1071-18</b>
20,0 cm, 8"	<b>75-1071-20</b>



**REYNOLDS**

15,0 cm, 6"	<b>75-1072-15</b>
18,0 cm, 7"	<b>75-1072-18</b>



**REYNOLDS**

15,0 cm, 6"	<b>75-1073-15</b>
18,0 cm, 7"	<b>75-1073-18</b>
20,0 cm, 8"	<b>75-1073-20</b>
23,0 cm, 9"	<b>75-1073-23</b>
25,0 cm, 10"	<b>75-1073-25</b>

Feine chirurgische Scheren  
Fine surgical scissors  
Tijeras finas para cirugía  
Forbici fine per chirurgia



19,0 cm, 7½"  
75-1074-19

25,0 cm, 10"  
75-1075-25

**THOREK**



75-1076-15

75-1077-15

15,0 cm, 6"

Nerv-Präparierscheren  
Nerve dissecting scissors  
Tijeras para nervios  
Forbici per dissezione di nervi

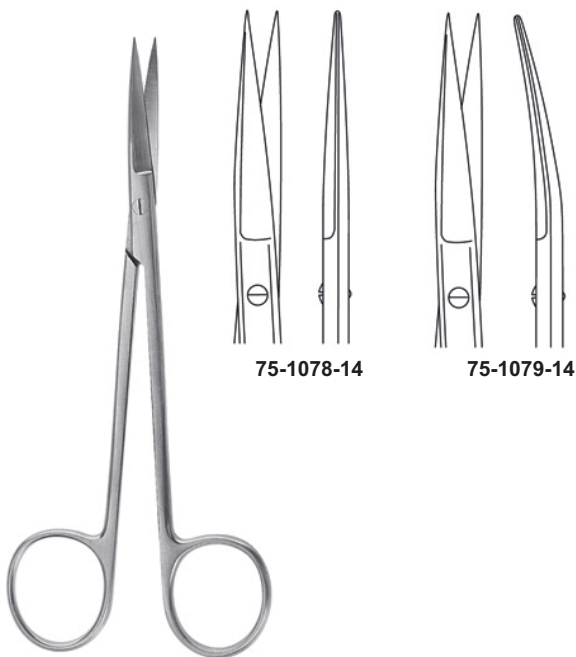

75-1078-14

75-1079-14

**SANVENERO**  
14,0 cm, 5½"

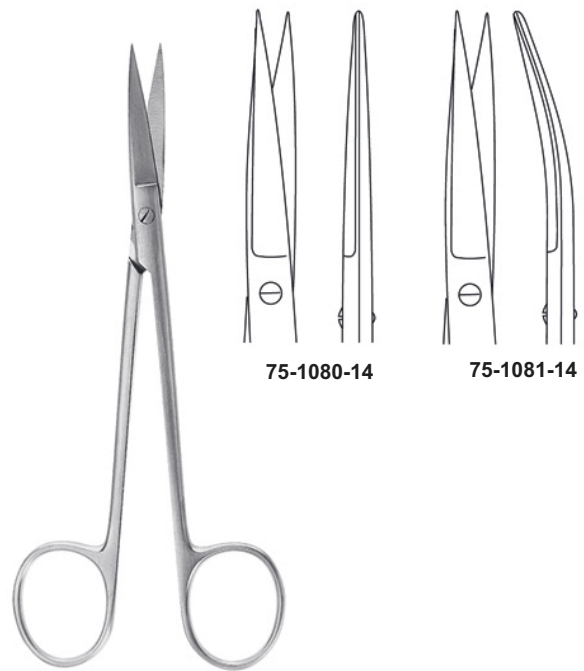

75-1080-14

75-1081-14

**JOSEPH**  
14,0 cm, 5½"

Feine chirurgische Scheren  
Fine surgical scissors  
Tijeras finas para cirugía  
Forbici fine per chirurgia

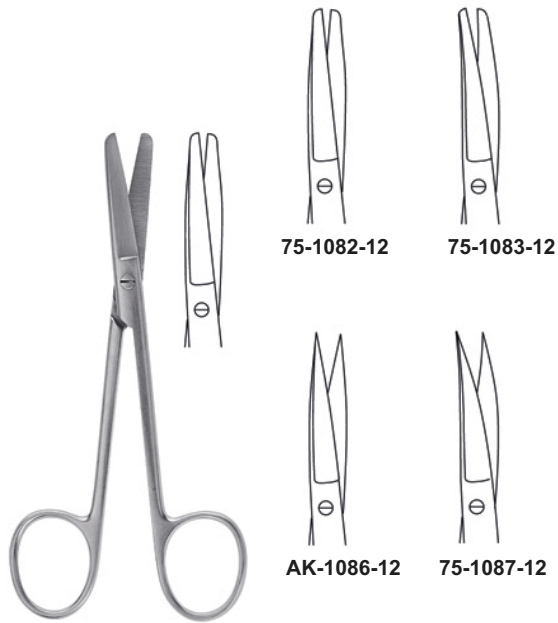

**WAGNER**

12,0 cm, 4<sup>3</sup>/<sub>4</sub>"



**STRABISMUS**

11,5 cm, 4<sup>1</sup>/<sub>2</sub>"

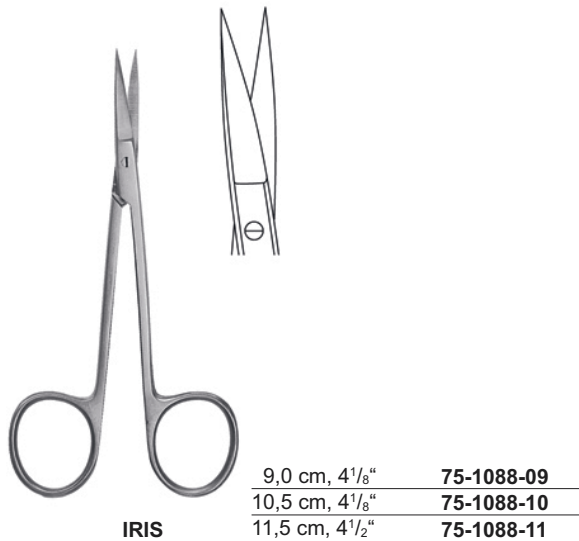

**IRIS**

9,0 cm, 4<sup>1</sup>/<sub>8</sub>"

**75-1088-09**

10,5 cm, 4<sup>1</sup>/<sub>8</sub>"

**75-1088-10**

11,5 cm, 4<sup>1</sup>/<sub>2</sub>"

**75-1088-11**



**IRIS**

9,0 cm, 4<sup>1</sup>/<sub>8</sub>"

**75-1089-09**

10,5 cm, 4<sup>1</sup>/<sub>8</sub>"

**75-1089-10**

11,5 cm, 4<sup>1</sup>/<sub>2</sub>"

**75-1089-11**

Feine chirurgische Scheren  
Fine surgical scissors  
Tijeras finas para cirugía  
Forbici fine per chirurgia



**IRIS**

10,5 cm, 4<sup>1</sup>/<sub>8</sub>"  
11,5 cm, 4<sup>1</sup>/<sub>2</sub>"

**75-1090-10**  
**75-1090-11**



**IRIS**

10,5 cm, 4<sup>1</sup>/<sub>8</sub>"  
11,5 cm, 4<sup>1</sup>/<sub>2</sub>"

**75-1091-10**  
**75-1091-11**



11,5 cm, 4<sup>1</sup>/<sub>2</sub>"  
**75-1092-11**



11,5 cm, 4<sup>1</sup>/<sub>2</sub>"  
**75-1093-11**

Feine chirurgische Scheren  
 Fine surgical scissors  
 Tijeras finas para cirugía  
 Forbici fine per chirurgia



75-1094-12

12,0 cm, 4<sup>3</sup>/<sub>4</sub>"



75-1095-12



**MOD. BONN**  
 8,0 cm, 3<sup>1</sup>/<sub>4</sub>"  
 75-1096-08



**MOD. BONN**  
 8,0 cm, 3<sup>1</sup>/<sub>4</sub>"  
 75-1097-08



**MOD. BONN**  
 8,0 cm, 3<sup>1</sup>/<sub>4</sub>"  
 75-1098-08



Feine chirurgische Scheren  
Fine surgical scissors  
Tijeras finas para cirugía  
Forbici fine per chirurgia

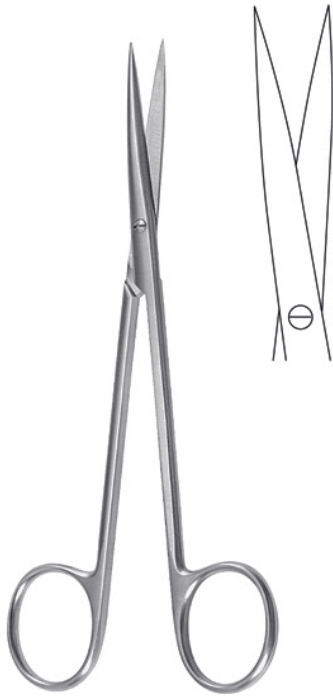

**BROPHY (SULLIVAN)**  
14,0 cm, 5 1/2"  
75-1099-14



**BROPHY (SULLIVAN)**  
14,0 cm, 5 1/2"  
75-1100-14

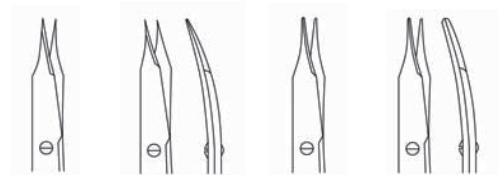

10,5 cm, 4 1/8"	75-1101-10	75-1102-10	75-1103 -10	75- 1104-10
11,5 cm, 4 1/2"	75-1101-11	75-1102-11	75-1103-11	75-1104-11

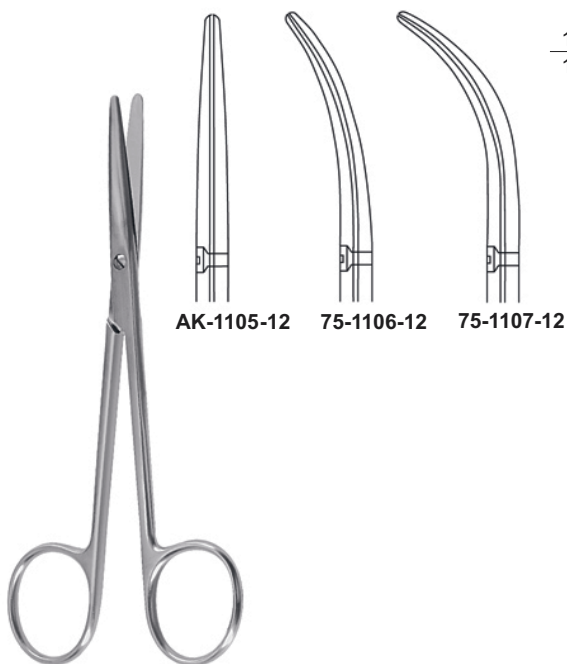

**LANDOLT**  
12,5 cm, 5"



**STEVENS**

**Chirurgische Scheren**  
**Surgical scissors**  
**Tijeras para cirugía**  
**Forbici per chirurgia**



Inzisionsscheren  
Incision scissors  
Tijeras para incisión  
Forbici vascolare e per fistole

13,0 cm, 5"      **75-1108-13**  
14,5 cm, 5¾"    **75-1108-14**



Inzisionsscheren  
Incision scissors  
Tijeras para incisión  
Forbici vascolare e per fi stole

**75-1109-16**  
16,5 cm, 36½"



**RICHTER**  
14,5 cm, 5¾"  
**75-1110-14**



**LAWSON TAIT**  
12,5 cm, 5"  
**75-1111-12**



**FERGUSON**  
16,5 cm, 6¼"      **75-1112-16**  
18,0 cm, 7"        **75-1112-18**



**TOENNIS**  
18,0 cm, 7"  
**75-1113-18**

Chirurgische Scheren, Ligaturscheren  
Surgical scissors, Ligature Scissors  
Tijeras para cirugía, Tijeras para ligaduras  
Forbici per chirurgia, Forbici per legature



**TOENNIS**  
18,0 cm, 7"  
75-1114-18



**HALLE**  
19,0 cm, 7½"  
75-1115-19

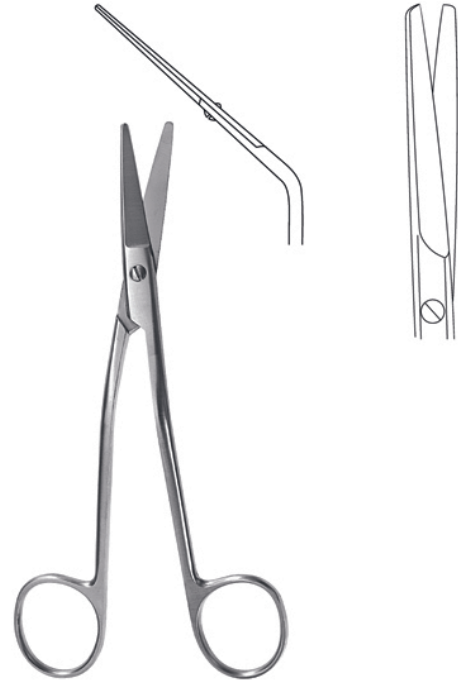

**FOMON**  
15,0 cm, 6"  
75-1116-15



**SPENCER**  
9,0 cm, 4⅛" 75-1117-09  
10,5 cm, 4⅛" 75-1117-10  
13,0 cm, 5" 75-1117-13



**LITTAUER**  
11,5 cm, 4¼" 75-1118-11  
14,0 cm, 5½" 75-1118-14



14,5 cm, 5¾"  
75-1119-14

18,0 cm, 7"  
75-1120-18

Ligaturscheren, Neurochirurgische Scheren  
Ligature Scissors, Neurosurgical Scissors  
Tijeras para ligaduras, Tijeras para Neurocirugía  
Forbici per legature, Forbici per Neurochirurgia

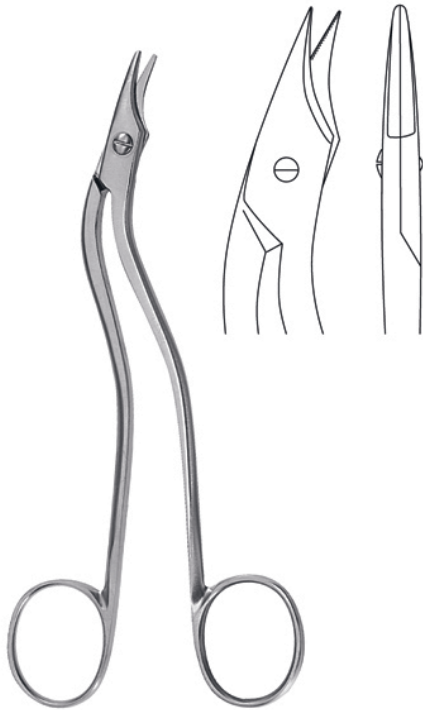

**HEATH**  
16,0 cm, 6<sup>1</sup>/<sub>4</sub>"  
75-1121-16



**NORTHBENT**  
9,0 cm, 3<sup>1</sup>/<sub>2</sub>"  
75-1122-09



**NORTHBENT**  
13,0 cm, 5"  
75-1123-13



**EISELSBERG**  
12,0 cm, 4<sup>3</sup>/<sub>4</sub>"  
75-1124-12

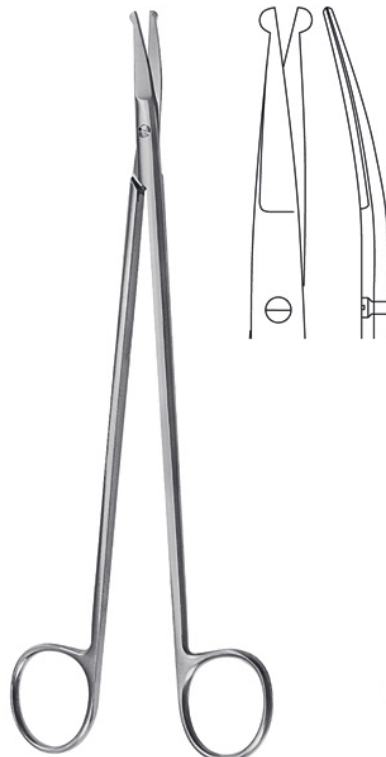

**STRULLY**  
22,0 cm, 8<sup>5</sup>/<sub>8</sub>"  
75-1125-22

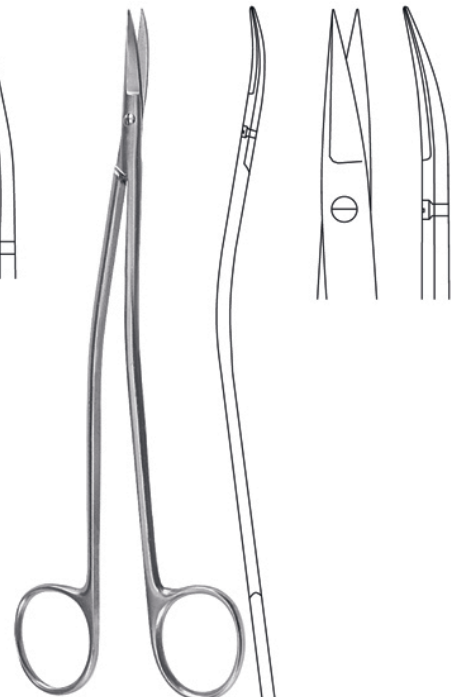

**DANDY**  
17,0 cm, 6<sup>3</sup>/<sub>4</sub>"  
75-1126-17

Neurochirurgische Scheren, Tonsillenscheren, Nasenscheren  
 Neurosurgical Scissors, Tonsil Scissors, Nasal Scissors  
 Tijeras para Neurocirugía, Tijeras para amígdalas, Tijeras para el tabique nasal  
 Forbici per Neurochirurgia, Forbici per tonsille, Forbici per il setto nasale

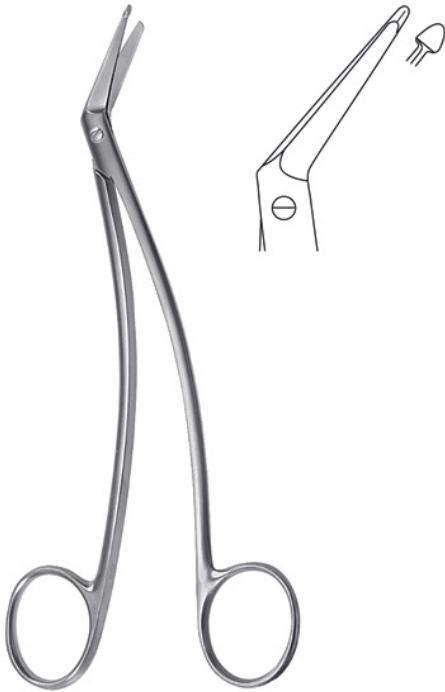

**SCHMIEDEN-TAYLOR**  
17,0 cm, 6<sup>3</sup>/<sub>4</sub>"  
75-1127-17

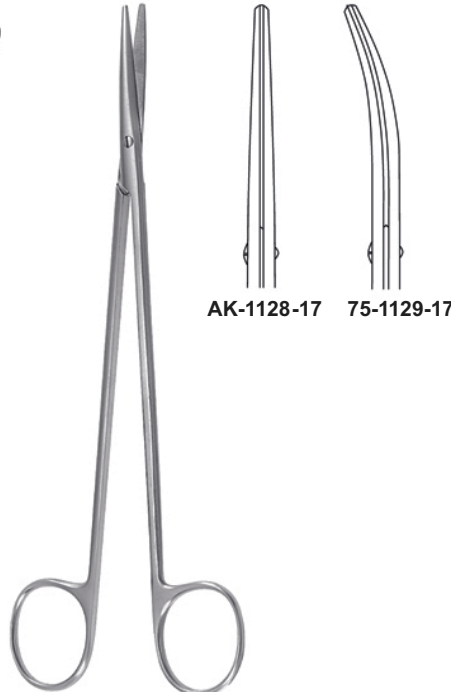

**LINCOLN**  
17,0 cm, 6<sup>3</sup>/<sub>4</sub>"



**HEYMANN**  
18,0 cm, 7"  
75-1130-18

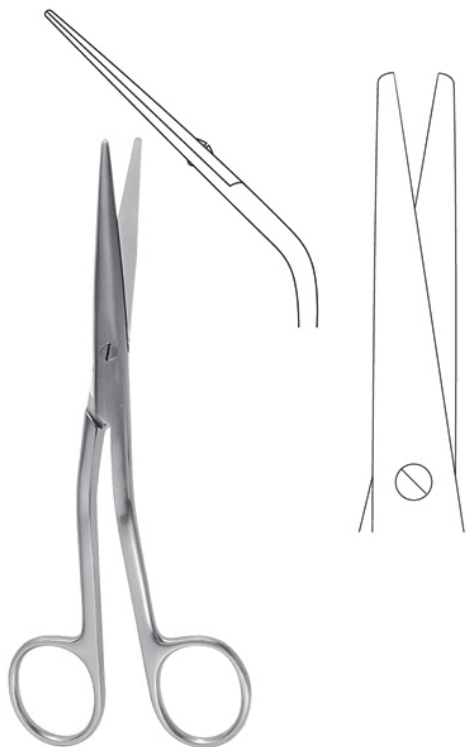

**COTTLE**  
16,0 cm, 6<sup>1</sup>/<sub>4</sub>"  
75-1131-16

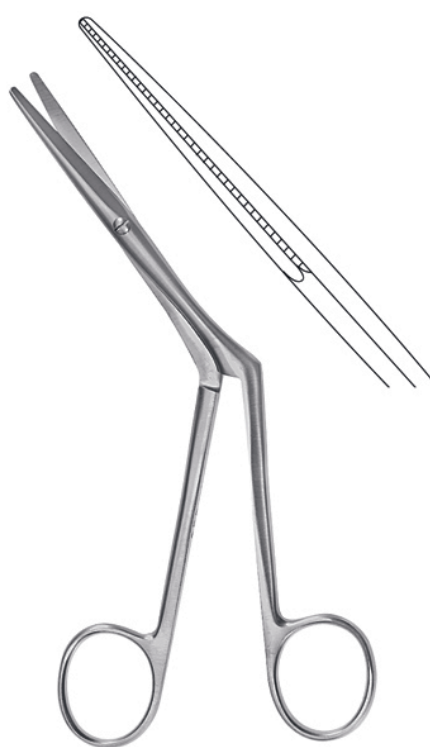

**KIRSTEN**  
18,0 cm, 7"  
75-1132-18



**CAPLAN**  
22,0 cm, 8<sup>5</sup>/<sub>8</sub>"  
75-1133-22

Tonsillenscheren, Nasenscheren, Gefäßscheren  
 Tonsil Scissors, Nasal Scissors, Vascular Scissors  
 Tijeras para amígdalas, Tijeras para el tabique nasal, Tijeras vasculares  
 Forbici per tonsille, Forbici per il setto nasale, Forbici vascolari



**BOETTCHER**  
 18,0 cm, 7"  
 75-1134-18

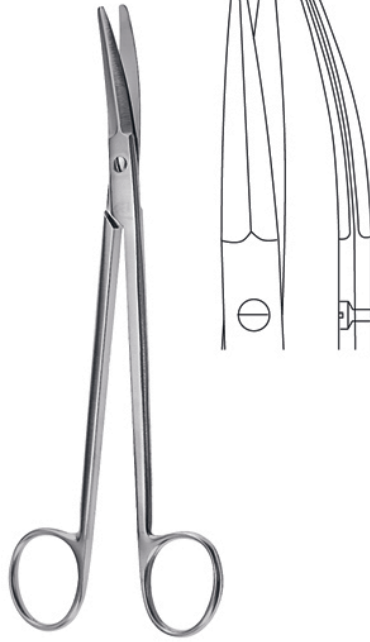

**PRINCE**  
 17,5 cm, 6<sup>5</sup>/<sub>8</sub>"  
 75-1135-17

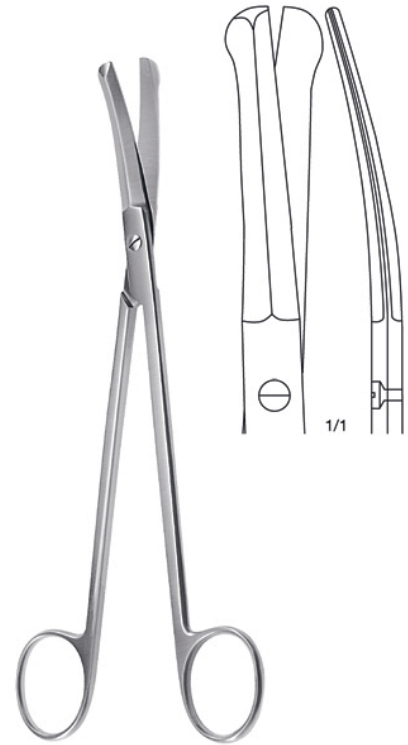

**GOOD**  
 19,0 cm, 7<sup>1</sup>/<sub>2</sub>"  
 75-1136-19



**CARTILAGE**  
 20,0 cm, 8"  
 75-1137-20



**DE BAKEY**

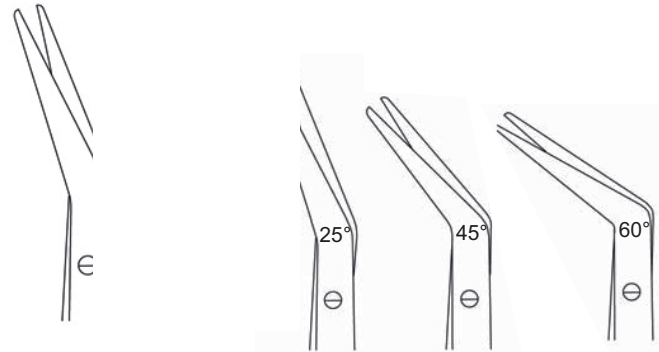

17,5 cm, 6 <sup>5</sup> / <sub>8</sub> "	75-1138-25	75-1143-45	75-1148-60
19,5 cm, 7 <sup>3</sup> / <sub>4</sub> "	75-1139-25	75-1144-45	75-1149-60
21,0 cm, 8 <sup>1</sup> / <sub>4</sub> "	75-1140-25	75-1145-45	75-1150-60
23,0 cm, 9"	75-1141-25	75-1146-45	75-1151-60
28,0 cm, 11"	75-1142-25	75-1147-45	75-1152-60

Gefäßscheren  
Vascular Scissors  
Tijeras vasculares  
Forbici vascolari

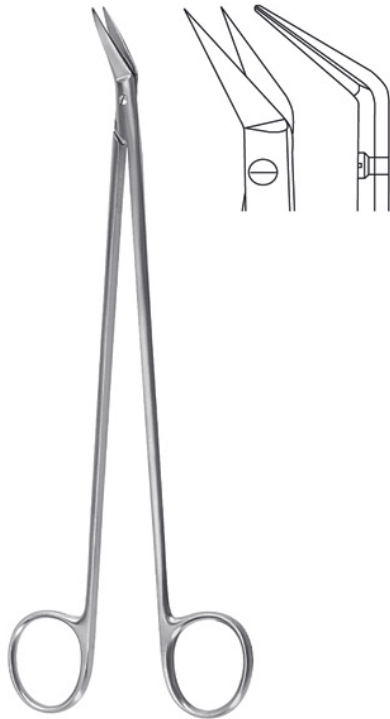

**POTTS-SMITH**  
18,0 cm, 7"  
75-1143-18

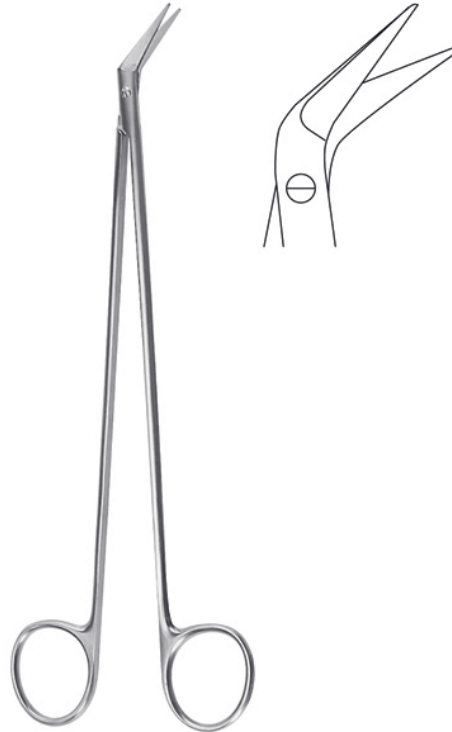

**POTTS DE MARTEL**  
21,0 cm, 8<sup>1</sup>/<sub>4</sub>" 75-1144-21  
24,0 cm, 9<sup>1</sup>/<sub>2</sub>" 75-1144-24



**DIETHRICH-HEGEMANN**  
19,0 cm, 7<sup>1</sup>/<sub>2</sub>"

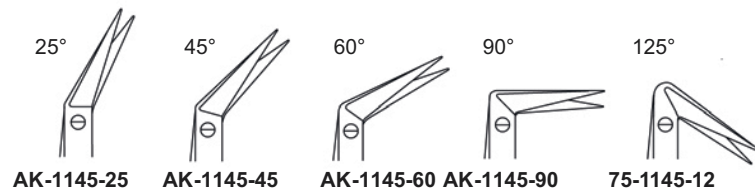

**Gefäßscheren**  
**Vascular Scissors**  
**Tijeras vasculares**  
**Forbici vascolari**



**DIETHRICH**  
20,0 cm, 7 1/2"  
75-1148-12

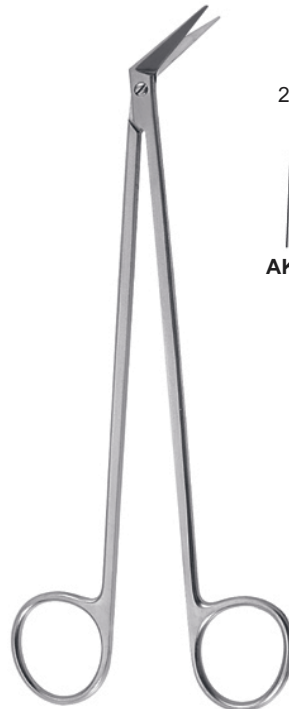

**POTTS-SMITH**  
19,0 cm, 7 1/2"

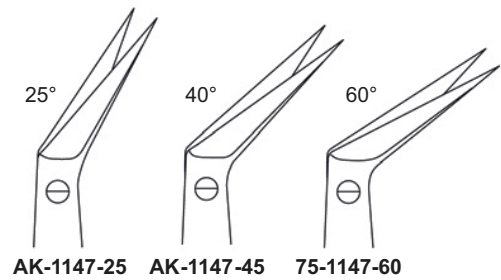

AK-1147-25    AK-1147-45    75-1147-60

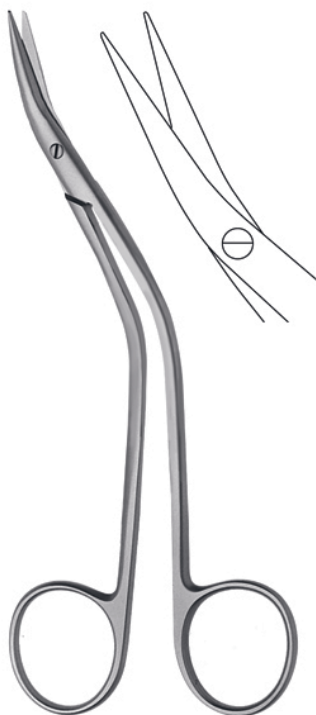

**DE BAKEY**  
15,5 cm, 6"  
75-1149-15

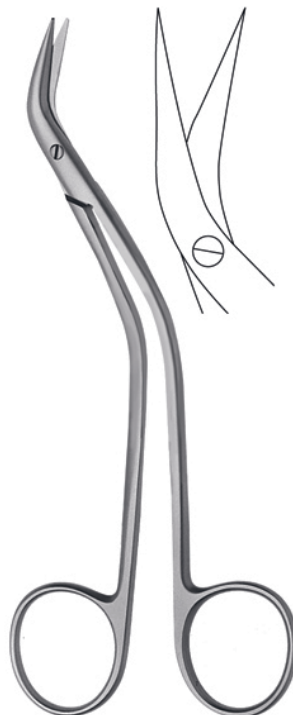

**DE BAKEY**  
15,5 cm, 6"  
75-1150-15



**DE BAKEY**  
15,5 cm, 6"  
75-1151-15



Gefäßscheren, Gynäkologische Scheren  
Vascular Scissors, Gynecology scissors  
Tijeras vasculares, Tijeras para ginecología  
Forbici vascolari, Forbici per ginecologia



**MC INDOE**  
19,0 cm, 7½"  
75-1152-19



geknöpftes Blatt  
probe-pointed blade  
punta botonda  
lame bottonuta

11,5 cm, 4½"  
75-1153-11



**CRAFOORD**  
30,0 cm, 12"  
75-1154-30



**SATINSKY**  
15,5 cm, 9⅝"  
75-1155-24



**KLINGENBERG-LOTH**  
23,0 cm, 9"  
75-1162-23



**SIMS**

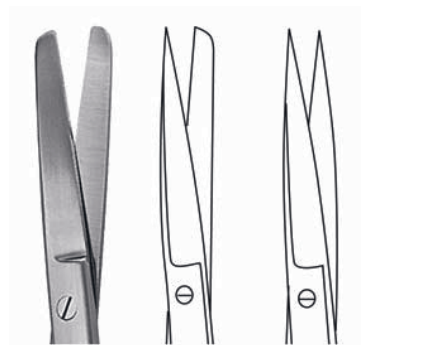

20,0 cm, 8"	<b>AK-1156-20</b>	<b>75-1157-20</b>	<b>AK-1158-20</b>
23,0 cm, 9"	<b>AK-1159-23</b>	<b>75-1160-23</b>	<b>AK-1161-23</b>

Gynäkologische Scheren  
Gynecology scissors  
Tijeras para ginecología  
Forbici per ginecologia



**SIMS**

20,0 cm, 8"  
23,0 cm, 9"



AK-1163-20 AK-1164-20 AK-1165 -20  
AK-1166-23 AK-1167-23 AK-1168 -23

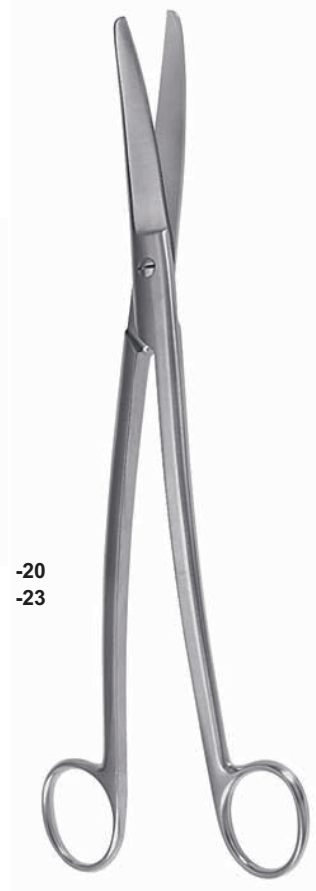

**SIEBOLD**  
24,0 cm, 9 1/2"  
75-1169-24



**BOZEMANN**  
22,0 cm, 8 3/4"  
75-1170-22



**DOYEN**

16,0 cm, 6 1/4" AK-1171-16 AK-1172-16 AK- 1173-16  
17,5 cm, 6 5/8" AK-1174-17 AK-1175-17 75-1176-16



**KELLY**

16,0 cm, 6 1/4" 75-1177-16  
18,0 cm, 7" 75-1177-18

Fistelscheren  
Fistula scissors  
Tijeras para fistulas  
Forbici per fistole

Gynäkologische Scheren, Darmscheren  
Gynecology scissors, Enterotomy Scissors  
Tijeras para ginecología, Tijeras enterótomos  
Forbici per ginecologia, Forbici per enterotomia



Fistelscheren  
Fistula scissors  
Tijeras para fistulas  
Forbici per fistole

**KELLY**

16,0 cm, 6<sup>1</sup>/<sub>4</sub>" **75-1179-16**  
18,0 cm, 7" **75-1179-18**



**WERTHEIM**

19,5 cm, 7<sup>3</sup>/<sub>4</sub>" **75-1180-19**  
22,5 cm, 8<sup>3</sup>/<sub>4</sub>" **75-1180-23**



**75-1178-18**

**DUBOIS**

27,0 cm, 10<sup>5</sup>/<sub>8</sub>" **75-1181-18**



**DARMSCHERE**  
21,0 cm, 8<sup>1</sup>/<sub>4</sub>"  
**75-1182-21**



**DARMSCHERE**  
21,0 cm, 8<sup>1</sup>/<sub>4</sub>"  
**75-1183-21**



**DARMSCHERE  
GEKNÖPFT**  
21,0 cm, 8<sup>1</sup>/<sub>4</sub>"  
**75-1184-21**



**LLOYD-DAVIES**  
27,0 cm, 10<sup>5</sup>/<sub>8</sub>"  
**75-1185-27**



Lungenlappen- und Rektumscheren, Lungenscheren, Dammscheren  
 Lobectomy and Rectal Scissors, Lobectomy Scissors, Episiotomy Scissors  
 Tijeras para lobectomía y recto, Tijera para lobectomía, Tijeras para episiotomía  
 Forbici per lobo polmonare e per il retto, Forbici per lobo, Forbici per episiotomia

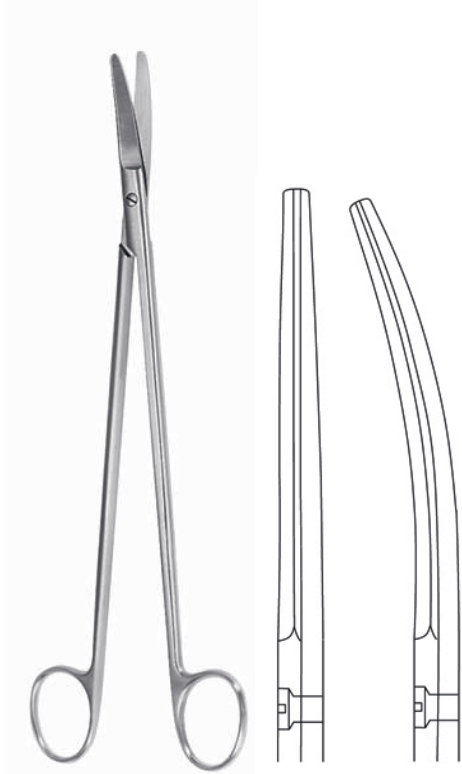

**STELZNER**      75-1186-31      75-1187-31  
 31,0 cm, 12<sup>3</sup>/<sub>4</sub>"

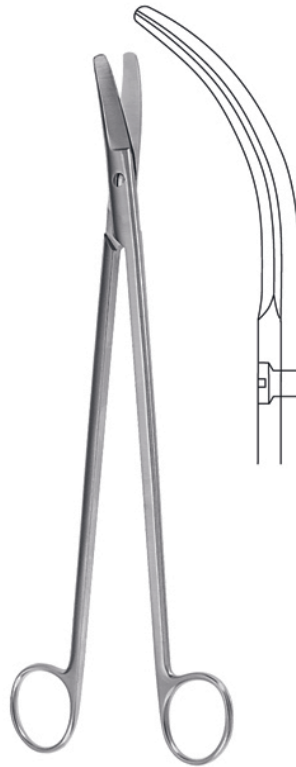

**RECTAL**  
 32,5 cm, 12<sup>3</sup>/<sub>4</sub>"  
 75-1188-32



**WILLAUER**  
 25,0 cm, 9<sup>3</sup>/<sub>4</sub>"      75-1189-25  
 28,0 cm, 11"      75-1189-28

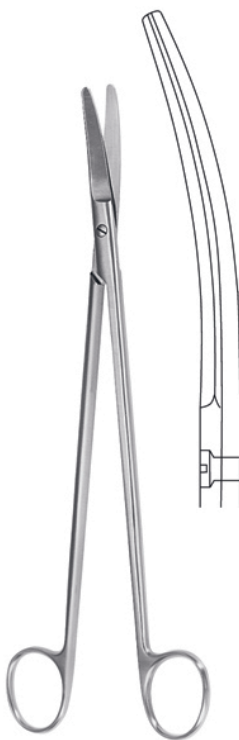

**WILLAUER**  
 25,0 cm, 9<sup>3</sup>/<sub>4</sub>"      75-1190-25  
 28,0 cm, 11"      75-1190-28



**POTTS-SMITH**  
 19,0 cm, 7<sup>1</sup>/<sub>2</sub>"  
 75-1191-19



**FINOCHIETTO**  
 32,5 cm, 10<sup>5</sup>/<sub>8</sub>"  
 75-1192-27

Lungenscheren, Dammscheren, Nabelschnurscheren  
 Lobectomy Scissors, Episiotomy Scissors, Umbilical Cord Scissors  
 Tijera para lobectomía, Tijeras para episiotomía, Tijeras umbilicales  
 Forbici per lobo, Forbici per episiotomia, Forbici ombelicali



**WALDMANN**  
18,0 cm, 7"  
75-1193-18



**BRAUN-STADLER**  
14,5 cm, 5<sup>3</sup>/<sub>4</sub>"      75-1194-14  
20,0 cm, 8"      75-1194-20



**EPISIOTOMIE SCHERE**  
20,0 cm, 8"  
75-1195-20



**MOD. USA**  
10,5 cm, 4<sup>1</sup>/<sub>8</sub>"  
75-1196-10



**BUSCH**  
13,5 cm, 5<sup>3</sup>/<sub>8</sub>"      75-1197-13  
16,0 cm, 6<sup>1</sup>/<sub>4</sub>"      75-1197-16



**SCHUMACHER**  
16,0 cm, 16<sup>1</sup>/<sub>4</sub>"  
75-1198-16

**Drahtscheren, Verband- und Kleiderstoffscheren**  
**Wire Scissors, Bandage and Cloth Scissors**  
**Cizallas corta-alambres, Tijeras para vendajes y tela**  
**Forbici taglia cavo, Forbici per bendaggi e vestiti**



gezahnt  
serrated  
dentada  
dentata

**UNIVERSAL**  
12,0 cm, 4<sup>3</sup>/<sub>4</sub>"  
75-1200-12



**LISTER**

9,0 cm, 3 <sup>1</sup> / <sub>2</sub> "	<b>75-1199-09</b>
11,0 cm, 4 <sup>3</sup> / <sub>8</sub> "	<b>75-1199-11</b>
14,0 cm, 5 <sup>1</sup> / <sub>2</sub> "	<b>75-1199-14</b>
18,0 cm, 7"	<b>75-1199-18</b>
20,0 cm, 8"	<b>75-1199-20</b>



**LISTER**

18,5 cm, 7 <sup>1</sup> / <sub>4</sub> "	<b>75-1201-18</b>
21,0 cm, 8 <sup>1</sup> / <sub>4</sub> "	<b>75-1201-21</b>



**LISTER-EXCENTRIC**

16,0 cm, 6 <sup>1</sup> / <sub>4</sub> "	<b>75-1202-16</b>
19,0 cm, 7 <sup>1</sup> / <sub>2</sub> "	<b>75-1202-19</b>



gezahnt  
serrated  
dentada  
dentata



**BERGMANN**

23,0 cm, 9"	<b>75-1203-23</b>
-------------	-------------------

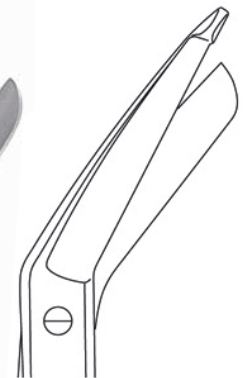

Verband- und Kleiderstoffscheren, Gipsscheren  
Bandage and Cloth Scissors, Plaster-of-Paris Shears  
Tijeras para vendajes y tela, Cizallas para escayolas  
Forbici per bendaggi e vestiti, Cesoie per gessi



**ESMARCH**  
20,0 cm, 8" **75-1204-20**  
22,0 cm, 8<sup>5</sup>/<sub>8</sub>" **75-1204-22**



**KNOWLES**  
14,0 cm, 5<sup>1</sup>/<sub>2</sub>"  
**75-1205-14**



gezahnt  
serrated  
dentada  
dentata

**BRUNS**  
24,0 cm, 9<sup>1</sup>/<sub>2</sub>"  
**75-1206-24**  
**75-1207-24**



**LORENZ**  
23,0 cm, 9"  
**75-1208-23**

bis 134°C autoklavierbar  
autoclavable up to 134°C  
esterilizable en autoclave hasta 134°C  
Sterilizzabile in autoclave fino 134°C



**SMITH**  
**(MOD. USA)**

16,0 cm, 6<sup>1</sup>/<sub>4</sub>" **75-1209-16**  
18,0 cm, 7" **75-1209-18**  
20,0 cm, 8" **75-1209-20**  
23,0 cm, 9" **75-1209-23**



gezahnt  
serrated  
dentada  
dentata

**GIPSSCHERE**  
20,0 cm, 8"  
**75-1210-20**



gezahnt  
serrated  
dentada  
dentata

**UNIVERSAL**  
14,0 cm, 5<sup>1</sup>/<sub>2</sub>" **75-1211-14**  
16,0 cm, 6<sup>1</sup>/<sub>4</sub>" **75-1211-16**  
18,0 cm, 7" **75-1211-18**

Chirurgische Scheren mit Hartmetallschneiden  
Surgical Scissors with tungsten carbide edges  
Tijeras para cirugía con filos de carburo tungsteno  
Forbici per chirurgia con lame in carburo di tungsteno



**STANDARD**

14,5 cm, 5 <sup>3</sup> / <sub>4</sub> "	<b>75-1212-14-TC</b>
16,5 cm, 6 <sup>1</sup> / <sub>2</sub> "	<b>75-1212-16-TC</b>
18,5 cm, 7 <sup>1</sup> / <sub>4</sub> "	<b>75-1212-18-TC</b>



**STANDARD**

14,5 cm, 5 <sup>3</sup> / <sub>4</sub> "	<b>75-1213-14-TC</b>
16,5 cm, 6 <sup>1</sup> / <sub>2</sub> "	<b>75-1213-16-TC</b>
18,5 cm, 7 <sup>1</sup> / <sub>4</sub> "	<b>75-1213-18-TC</b>



**STANDARD**

14,5 cm, 5 <sup>3</sup> / <sub>4</sub> "	<b>75-1214-14-TC</b>
16,5 cm, 6 <sup>1</sup> / <sub>2</sub> "	<b>75-1214-16-TC</b>
18,5 cm, 7 <sup>1</sup> / <sub>4</sub> "	<b>75-1214-18-TC</b>



**STANDARD**

14,5 cm, 5 <sup>3</sup> / <sub>4</sub> "	<b>75-1215-14-TC</b>
16,5 cm, 6 <sup>1</sup> / <sub>2</sub> "	<b>75-1215-16-TC</b>
18,5 cm, 7 <sup>1</sup> / <sub>4</sub> "	<b>75-1215-18-TC</b>



**STANDARD**

14,5 cm, 5 <sup>3</sup> / <sub>4</sub> "	<b>75-1216-14-TC</b>
16,5 cm, 6 <sup>1</sup> / <sub>2</sub> "	<b>75-1216-16-TC</b>
18,5 cm, 7 <sup>1</sup> / <sub>4</sub> "	<b>75-1216-18-TC</b>



**STANDARD**

14,5 cm, 5 <sup>3</sup> / <sub>4</sub> "	<b>75-1217-14-TC</b>
16,5 cm, 6 <sup>1</sup> / <sub>2</sub> "	<b>75-1217-16-TC</b>
18,5 cm, 7 <sup>1</sup> / <sub>4</sub> "	<b>75-1217-18-TC</b>



Chirurgische Scheren mit Hartmetallschneiden  
Surgical Scissors with tungsten carbide edges  
Tijeras para cirugía con filos de carburo tungsteno  
Forbici per chirurgia con lame in carburo di tungsteno



**MAYO**

14,5 cm, 5 <sup>3</sup> / <sub>4</sub> "	<b>75-1218-14 -TC</b>
17,0 cm, 6 <sup>3</sup> / <sub>4</sub> "	<b>75-1218-17-TC</b>
23,0 cm, 9"	<b>75-1218-23-TC</b>



**MAYO**

14,5 cm, 5 <sup>3</sup> / <sub>4</sub> "	<b>75-1219-14 -TC</b>
17,0 cm, 6 <sup>3</sup> / <sub>4</sub> "	<b>75-1219-17-TC</b>
23,0 cm, 9"	<b>75-1219-23-TC</b>



**MAYO-STILLE**

15,0 cm, 6"	<b>75-1220-15 -TC</b>
17,0 cm, 6 <sup>3</sup> / <sub>4</sub> "	<b>75-1220-17 -TC</b>



**MAYO-STILLE**

15,0 cm, 6"	<b>75-1221-15-TC</b>
17,0 cm, 6 <sup>3</sup> / <sub>4</sub> "	<b>75-1221-17-TC</b>



**LEXER**

16,0 cm, 6 <sup>1</sup> / <sub>4</sub> "	<b>75-1222-16-TC</b>
21,0 cm, 8 <sup>1</sup> / <sub>4</sub> "	<b>AK-1222-21-TC</b>



**LEXER**

16,0 cm, 6 <sup>1</sup> / <sub>4</sub> "	<b>75-1223-16 -TC</b>
21,0 cm, 8 <sup>1</sup> / <sub>4</sub> "	<b>75-1223-21 -TC</b>

**Präparierscheren mit Hartmetallschneiden**  
**Dissecting Scissors with tungsten carbide edges**  
**Tijeras para disección con filos de carburo tungsteno**  
**Forbici per dissezione con lame in carburo di tungsteno**

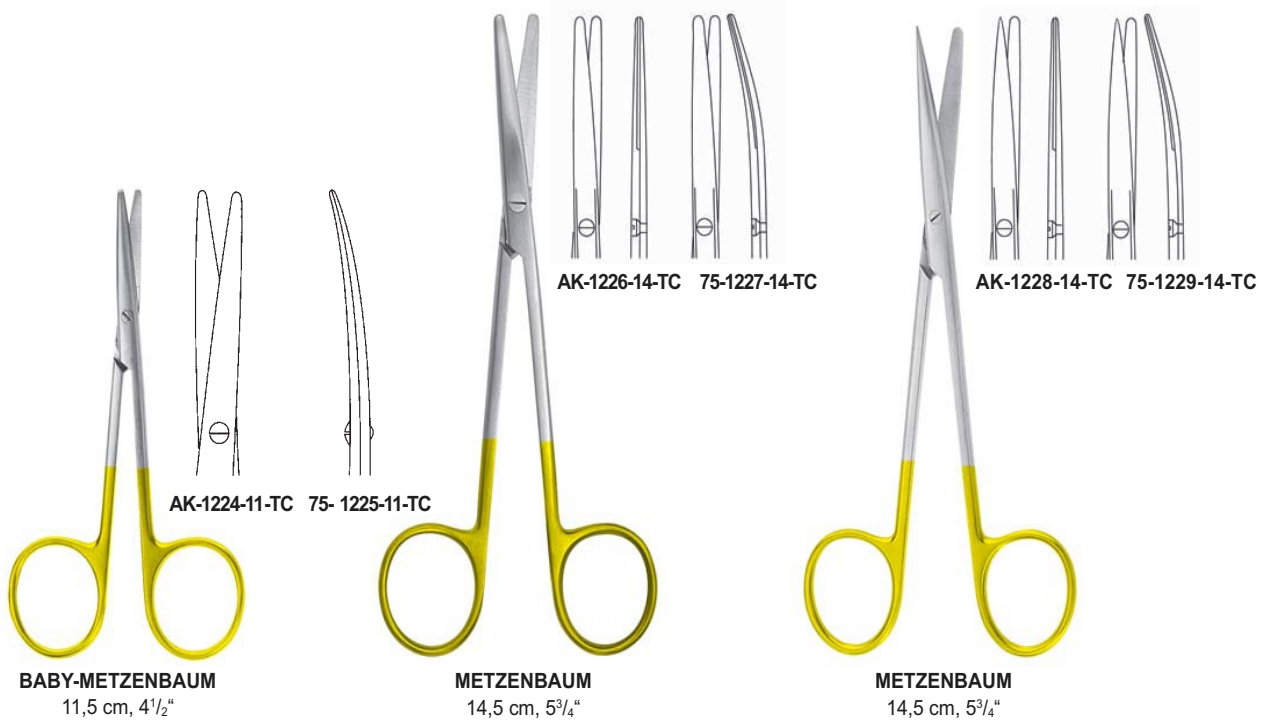



18,0 cm, **775-1234-18-TC**  
 20,0 cm, **875-1234-20-TC**  
 23,0 cm, **975-1234-23-TC**  
 25,0 cm, 10" **75-1234-25-TC**  
 28,0 cm, 11" **75-1234-28-TC**  
 30,0 cm, 12" **75-1234-30-TC**

**METZENBAUM**

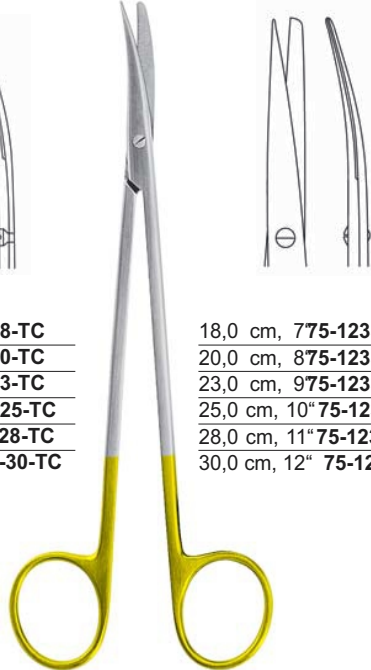

18,0 cm, **775-1235-18-TC**  
 20,0 cm, **875-1235-20-TC**  
 23,0 cm, **975-1235-23-TC**  
 25,0 cm, 10" **75-1235-25-TC**  
 28,0 cm, 11" **75-1235-28-TC**  
 30,0 cm, 12" **75-1235-30-TC**

**METZENBAUM**

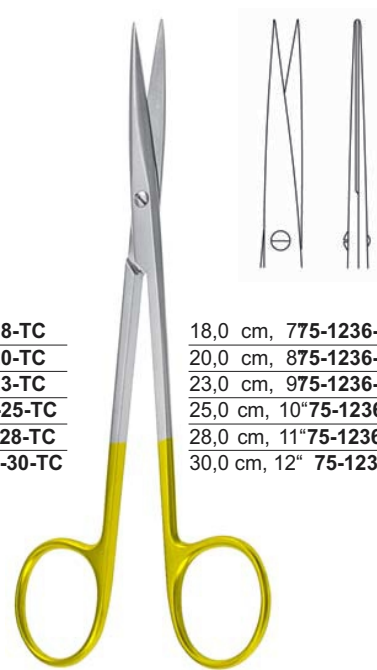

18,0 cm, **775-1236-18-TC**  
 20,0 cm, **875-1236-20-TC**  
 23,0 cm, **975-1236-23-TC**  
 25,0 cm, 10" **75-1236-25-TC**  
 28,0 cm, 11" **75-1236-28-TC**  
 30,0 cm, 12" **75-1236-30-TC**

**METZENBAUM**



18,0 cm, 7" **75-1237-18-TC**  
 20,0 cm, 8" **75-1237-20-TC**  
 23,0 cm, 9" **75-1237-23-TC**  
 25,0 cm, 10" **75-1237-25-TC**  
 28,0 cm, 11" **75-1237-28-TC**  
 30,0 cm, 12" **75-1237-30-TC**

**METZENBAUM**

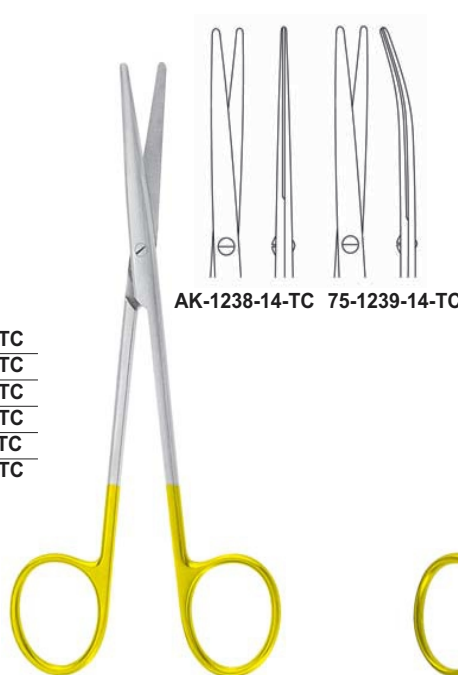

**AK-1238-14-TC 75-1239-14-TC**

**METZENBAUM-FINO**

14,5 cm, 5<sup>3</sup>/<sub>4</sub>"

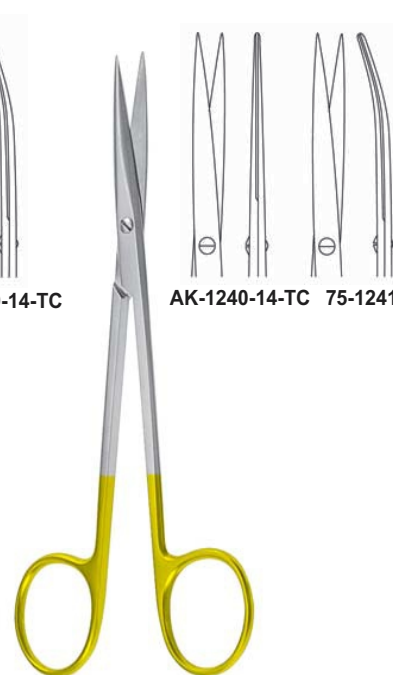

**AK-1240-14-TC 75-1241-14-TC**

**METZENBAUM-FINO**

14,5 cm, 5<sup>3</sup>/<sub>4</sub>"

**Präparierscheren mit Hartmetallschneiden**  
**Dissecting Scissors with tungsten carbide edges**  
**Tijeras para disección con filos de carburo tungsteno**  
**Forbici per dissezione con lame in carburo di tungsteno**

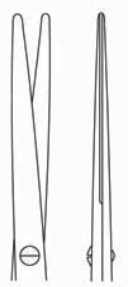
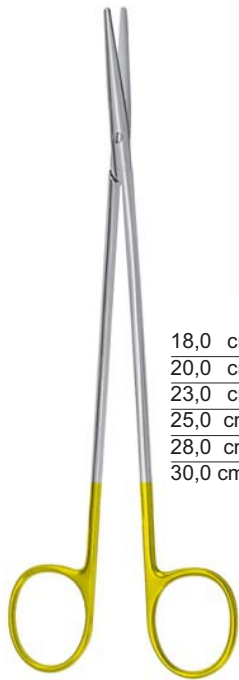

18,0 cm, 7" **75-1242-18-TC**  
 20,0 cm, 8" **75-1242-20-TC**  
 23,0 cm, 9" **75-1242-23-TC**  
 25,0 cm, 10" **75-1242-25-TC**  
 28,0 cm, 11" **75-1242-28-TC**  
 30,0 cm, 12" **75-1242-30-TC**

**METZENBAUM-FINO**

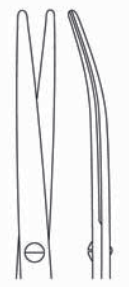
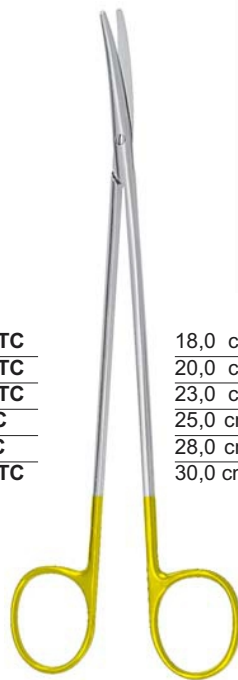

18,0 cm, **775-1243-18-TC**  
 20,0 cm, **875-1243-20-TC**  
 23,0 cm, **975-1243-23-TC**  
 25,0 cm, 10" **75-1243-25-TC**  
 28,0 cm, 11" **75-1243-28-TC**  
 30,0 cm, 12" **75-1243-30-TC**

**METZENBAUM-FINO**

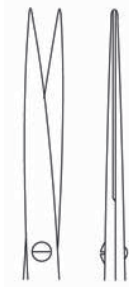

18,0 cm, **775-1244-18-TC**  
 20,0 cm, **875-1244-20-TC**  
 23,0 cm, **975-1244-23-TC**  
 25,0 cm, 10" **75-1244-25-TC**  
 28,0 cm, 11" **75-1244-28-TC**  
 30,0 cm, 12" **75-1244-30-TC**

**METZENBAUM-FINO**

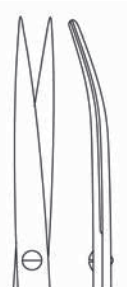

18,0 cm, 7" **75-1245-18-TC**  
 20,0 cm, 8" **75-1245-20-TC**  
 23,0 cm, 9" **75-1245-23-TC**  
 25,0 cm, 10" **75-1245-25-TC**  
 28,0 cm, 11" **75-1245-28-TC**  
 30,0 cm, 12" **75-1245-30-TC**

**METZENBAUM-FINO**



**METZENBAUM-LAHEY**  
 14,0 cm, 5 1/2"  
**75-1246-14-TC**

**METZENBAUM-LAHEY**



**TOENNIS-ADSON**  
 17,0 cm, 6 3/4"  
**75-1247-17-TC**

**TOENNIS-ADSON**

Präparierscheren mit Hartmetallschneiden  
 Dissecting Scissors with tungsten carbide edges  
 Tijeras para disección con filos de carburo tungsteno  
 Forbici per dissezione con lame in carburo di tungsteno

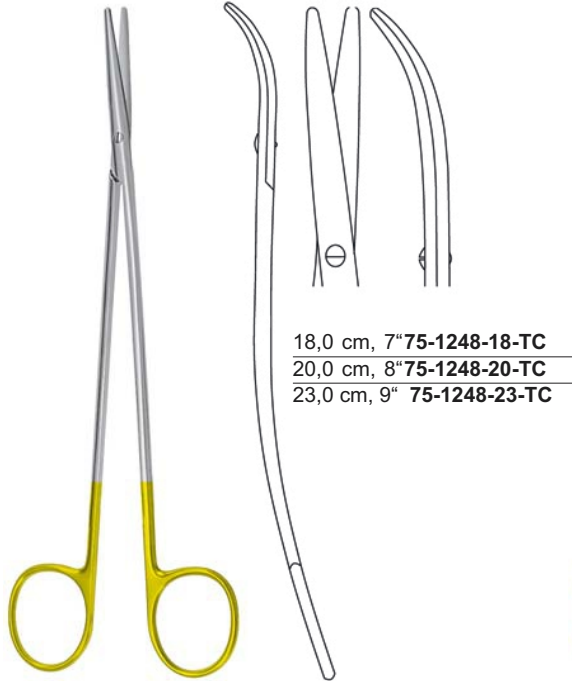

18,0 cm, 7" **75-1248-18-TC**  
 20,0 cm, 8" **75-1248-20-TC**  
 23,0 cm, 9" **75-1248-23-TC**

**METZENBAUM-FINO S**



18,0 cm, 7" **75-1249-18-TC**  
 20,0 cm, 8" **75-1249-20-TC**  
 23,0 cm, 9" **75-1249-23-TC**

**METZENBAUM-FINO S**



**REYNOLDS**  
 15,0 cm, 6"  
**75-1250-15-TC**



**REYNOLDS**  
 15,0 cm, 6"  
**75-1251-15-TC**



**HYSTEREKTOMY**  
 25,5 cm, 10"  
**75-1252-25-TC**



**HYSTEREKTOM**  
 Y 25,0 cm, 9<sup>3</sup>/<sub>4</sub>"  
**75-1253-25-TC**

Gynäkologische Scheren mit Hartmetallschneiden  
 Gynecology Scissors with tungsten carbide edges  
 Tijeras para ginecología con filos de carburo tungsteno  
 Forbici per ginecologia con lame in carburo di tungsteno



SIMS

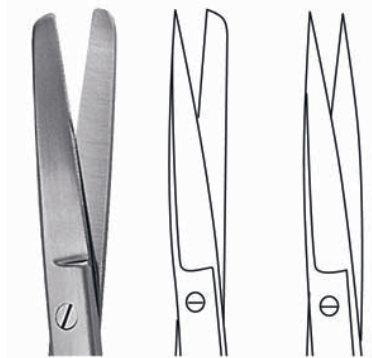

20,0 cm, 8"	<b>75-1254-20-TC</b>	<b>75-1255 -20-TC</b>	<b>75-1256-20-TC</b>
23,0 cm, 9"	<b>75-1254-23-TC</b>	<b>75-1255-23-TC</b>	<b>75-1256-23-TC</b>



SIMS



20,0 cm, 8"	<b>75-1257-20-TC</b>	<b>75-1258-20-TC</b>	<b>75-1259-20-TC</b>
23,0 cm, 9"	<b>75-1257-23-TC</b>	<b>75-1258-23-TC</b>	<b>75-1259-23-TC</b>

Gefäßscheren mit Hartmetallschneiden  
 Vascular Scissors with tungsten carbide edges  
 Tijeras vasculares con filos de carburo tungsteno  
 Forbici vascolari con lame in carburo di tungsteno



**DIETHRICH**  
17,5 cm, 6<sup>5</sup>/<sub>8</sub>"  
75-1260-17-TC



**POTTS DE MARTEL**  
24,0 cm, 9<sup>1</sup>/<sub>2</sub>"  
75-1261-24-TC



**DE BAKEY**

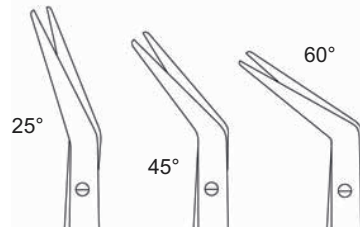

20,0 cm, 8"	75-1262-25-TC	75-1264-45-TC	75-1266-60-TC
23,0 cm, 9"	75-1263-25-TC	75-1265-45-TC	75-1267-60-TC

# Surgical Catalogue

Gefäßscheren mit Hartmetallschneiden  
 Vascular Scissors with tungsten carbide edges  
 Tijeras vasculares con filos de carburo tungsteno  
 Forbici vascolari con lame in carburo di tungsteno



**DIETRICH-HEGEMANN**  
18,0 cm, 7"

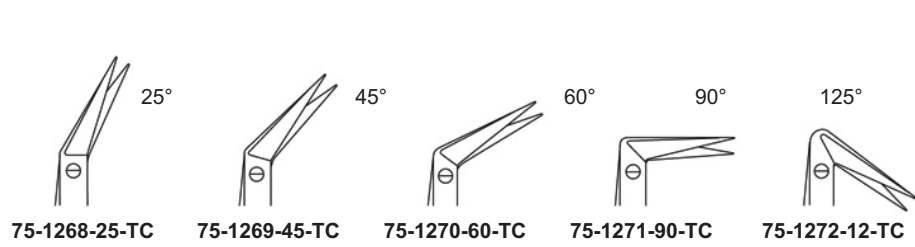

**POTTS-SMITH**  
18,0 cm, 7 1/2"

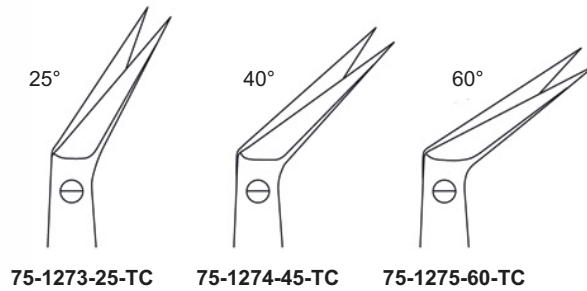



Scheren mit Hartmetallschneiden  
Scissors with tungsten carbide edges  
Tijeras con filos de carburo tungsteno  
Forbici con lame in carburo di tungsteno



**IRIS**  
11,5 cm, 4½"



**UNIVERSAL**  
12,0 cm, 4¾"  
75-1279-12-TC

gezahnt  
serrated  
dentada  
dentata



**LISTER**  
18,0 cm, 7"  
75-1280-18-TC

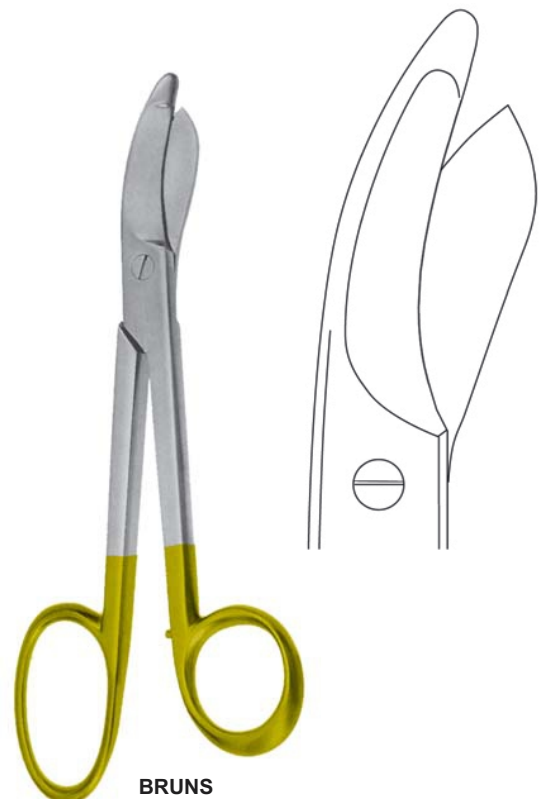

**BRUNS**  
24,0 cm, 9½"  
75-1281-24-TC

**Super-Cut Scheren  
Super-Cut Scissors  
Tijeras Super-Cut  
Forbici Super-Cut**



**MAYO**  
17,0 cm, 6<sup>3</sup>/<sub>4</sub>"

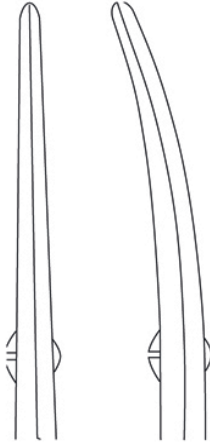

**AK-1284-17-SC 75-1285-17-SC**



**METZENBAUM**



14,5 cm, 5<sup>3</sup>/<sub>4</sub>" **75-1282-14-SC**  
18,0 cm, 7" **75-1282-18-SC**  
20,0 cm, 8" **75-1282-20-SC**  
23,0 cm, 9" **75-1282-23-SC**

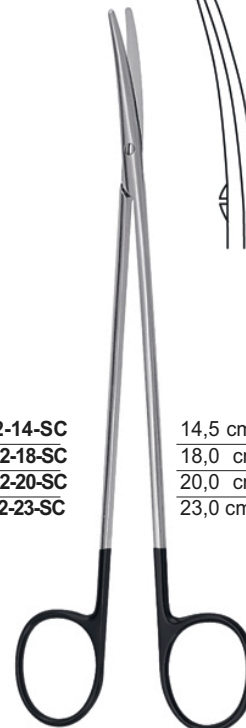

**METZENBAUM-FINO**



14,5 cm, 5<sup>3</sup>/<sub>4</sub>" **75-1283-14-SC**  
18,0 cm, 7" **75-1283-18-SC**  
20,0 cm, 8" **75-1283-20-SC**  
23,0 cm, 9" **75-1283-23-SC**



**KAYE FACE LIFT**



15,0 cm, 6" **75-1286-15-SC**  
19,0 cm, 7<sup>1</sup>/<sub>2</sub>" **75-1287-19-SC**



**JABALEY**  
13,0 cm, 5"  
**75-1288-13-SC**



**ENDARTERECTOMY**  
18,0 cm, 7"  
**75-1289-18-SC**



**TOENNIS-ADSON**  
17,0 cm, 6<sup>3</sup>/<sub>4</sub>"  
**75-1290-17-SC**

Super-Cut Scheren  
Super-Cut Scissors  
Tijeras Super-Cut  
Forbici Super-Cut

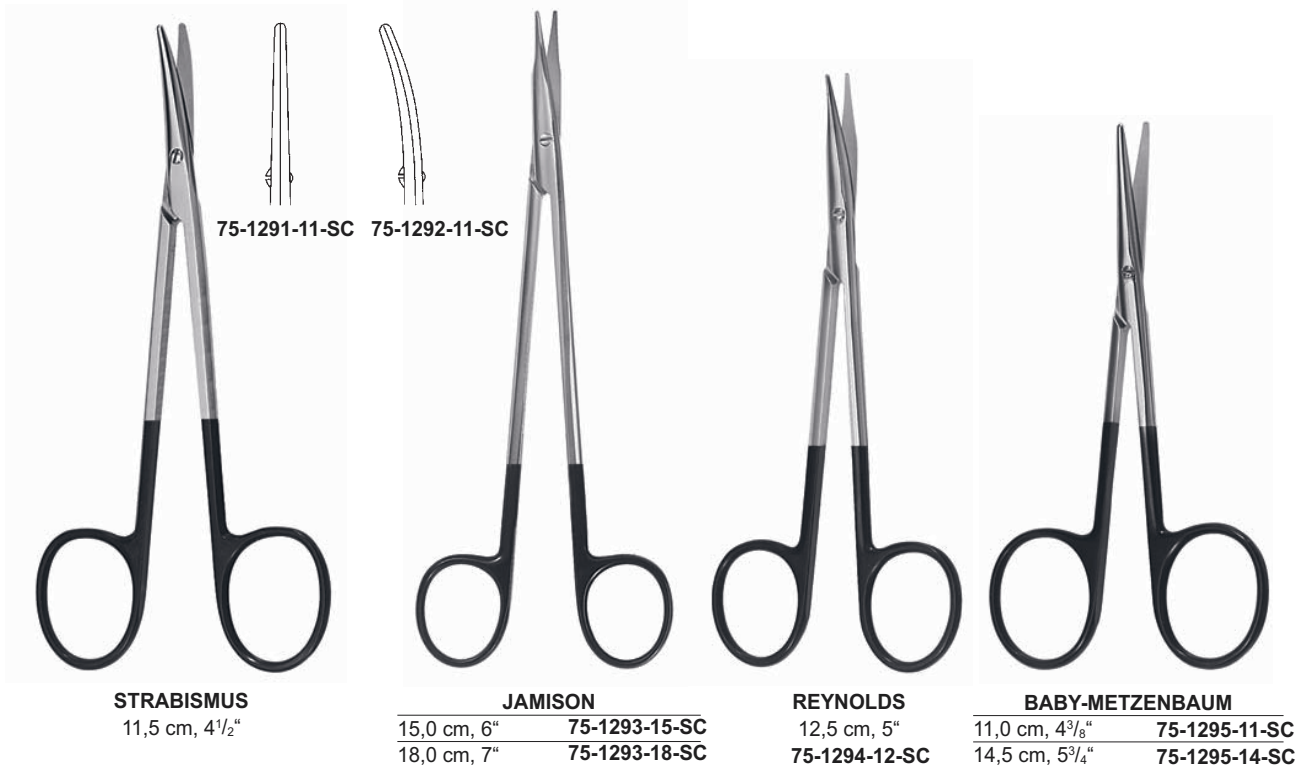

Super-Cut Scheren  
Super-Cut Scissors  
Tijeras Super-Cut  
Forbici Super-Cut



**PAR TYPE**  
12,0 cm, 4<sup>3</sup>/<sub>4</sub>"  
75-1303-12-SC



**PAR TYPE**  
12,0 cm, 4<sup>3</sup>/<sub>4</sub>"  
75-1304-12-SC



**POTTS**  
19,0 cm, 7<sup>1</sup>/<sub>2</sub>"

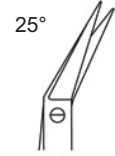

75-1300-25-SC

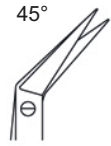

75-1301-45-SC

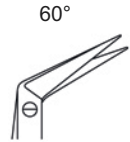

75-1302-60-SC



**FOMON**  
14,5 cm, 5<sup>3</sup>/<sub>4</sub>"  
75-1305-15-SC

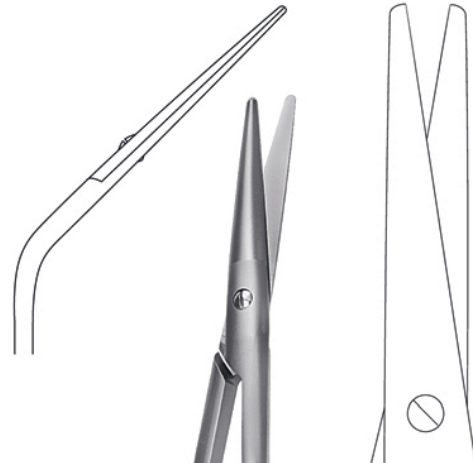

**COTTLE**  
16,5 cm, 6<sup>1</sup>/<sub>2</sub>"  
75-1306-16-SC

**Mikro-Scheren  
Micro Scissors  
Micro-Tijeras  
Micro-Forbici**

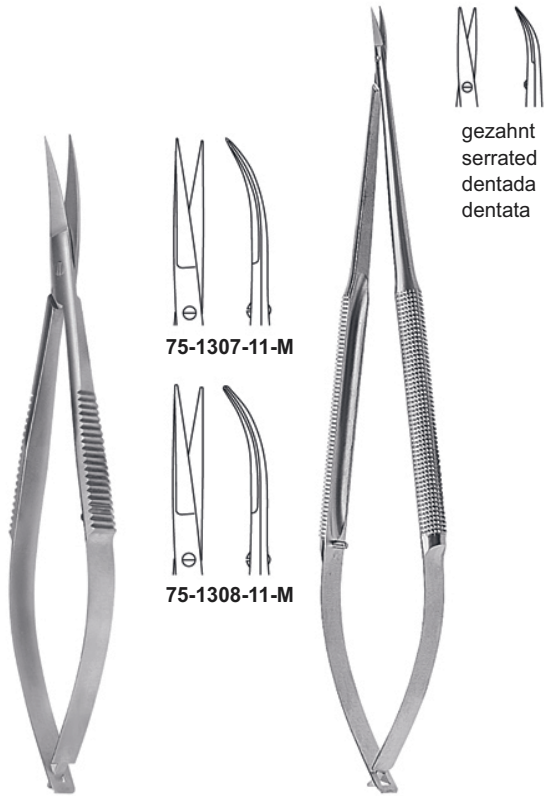

gezahnt  
serrated  
dentada  
dentata

75-1307-11-M

75-1308-11-M

**WESTCOTT**  
11,0 cm, 4<sup>3</sup>/<sub>8</sub>"

**GOMEL**  
14,0 cm, 5<sup>1</sup>/<sub>2</sub>" **75-1312-14-M**  
16,0 cm, 6<sup>1</sup>/<sub>4</sub>" **75-1312-16-M**



Mikro-Präparierscheren  
Micro-dissecting scissors  
Micro-tijeras de disección  
Micro-forbici per dissezione

**HEPP SCHEIDEL**  
14,0 cm, 5<sup>1</sup>/<sub>2</sub>" **75-1313-14-M**  
16,0 cm, 6<sup>1</sup>/<sub>4</sub>" **75-1313-16-M**

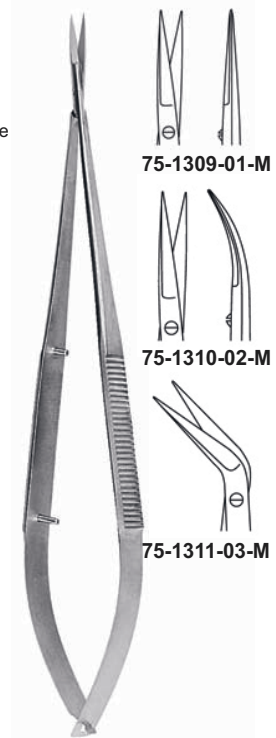

18,5 cm, 7<sup>1</sup>/<sub>4</sub>"



**SIMS**



18,5 cm, 7<sup>1</sup>/<sub>4</sub>" **AK-1314-01** **AK-1315-02** **AK-1316-03** **AK-1318-04**  
22,5 cm, 8<sup>3</sup>/<sub>4</sub>" **75-1319-01** **75-1320-02** **75-1321-03** **75-1322-04**



18,5 cm, 7<sup>1</sup>/<sub>4</sub>" **AK-1323-01-M** **AK-1325-02-M**  
22,5 cm, 8<sup>3</sup>/<sub>4</sub>" **AK-1324-01-M** **AK-1326-02-M**

**Mikro-Scheren, Mikro-Disektionsscheren**  
**Micro Scissors, Micro Dissecting Scissors**  
**Micro-Tijeras, Micro-Tijeras de disección**  
**Micro-Forbici, Micro-Forbici per dissezione**



18,0 cm, 7"



75-1327-25-M

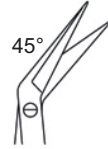

75-1328-45-M

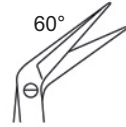

75-1329-60-M

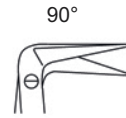

75-1330-90-M



75-1331-12-M



75-1332-25-M



75-1333-45-M

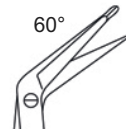

75-1334-60-M

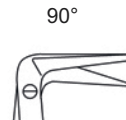

75-1335-90-M



75-1336-12-M



15,0 cm, 6"  
75-1337-15-M



15,0 cm, 6"  
75-1338-15-M



gezahnt  
serrated  
dentada  
dentata



15,0 cm, 6"  
75-1339-15-M



18,0 cm, 7"  
75-1340-18-M

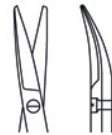

**Mikro-Adventitiascheren**  
**Micro Adventitia Scissors**  
**Micro-Tijeras Adventitia**  
**Micro-Forbici Adventitia**



15,0 cm, 6"  
75-1341-15 -M



15,0 cm, 6"  
75-1342-15 -M



gezahnt  
serrated  
dentada  
dentata



15,0 cm, 6"  
75-1343-15 -M



18,0 cm, 7"  
75-1344-18-M





**Pinzetten**

**Forceps**

**Pinzas**

**Pinze**



Anatomische Pinzetten  
Dissecting Forceps  
Pinzas de disección  
Pinze anatomiche per dissezione



**STANDARD**

10,5 cm, 4 <sup>1</sup> / <sub>8</sub> "	<b>75-1345-10</b>
11,5 cm, 4 <sup>1</sup> / <sub>2</sub> "	<b>75-1345-11</b>
13,0 cm, 5"	<b>75-1345-13</b>
14,5 cm, 5 <sup>3</sup> / <sub>4</sub> "	<b>75-1345-14</b>
15,0 cm, 6"	<b>75-1345-15</b>
16,0 cm, 6 <sup>1</sup> / <sub>4</sub> "	<b>75-1345-16</b>
18,0 cm, 7"	<b>75-1345-18</b>
20,0 cm, 8"	<b>75-1345-20</b>
25,0 cm, 10"	<b>75-1345-25</b>
30,0 cm, 12"	<b>75-1345-30</b>



schmal  
narrow  
estrechos  
stretti

**STANDARD**

10,5 cm, 4 <sup>1</sup> / <sub>8</sub> "	<b>75-1346-10</b>
11,5 cm, 4 <sup>1</sup> / <sub>2</sub> "	<b>75-1346-11</b>
13,0 cm, 5"	<b>75-1346-13</b>
14,5 cm, 5 <sup>3</sup> / <sub>4</sub> "	<b>75-1346-14</b>
15,0 cm, 6"	<b>75-1346-15</b>
16,0 cm, 6 <sup>1</sup> / <sub>4</sub> "	<b>75-1346-16</b>
18,0 cm, 7"	<b>75-1346-18</b>
20,0 cm, 8"	<b>75-1346-20</b>
25,0 cm, 10"	<b>75-1346-25</b>
30,0 cm, 12"	<b>75-1346-30</b>



schmal  
narrow  
estrechos  
stretti

**STANDARD**

10,5 cm, 4 <sup>1</sup> / <sub>8</sub> "	<b>75-1347-10</b>
11,5 cm, 4 <sup>1</sup> / <sub>2</sub> "	<b>75-1347-11</b>
13,0 cm, 5"	<b>75-1347-13</b>
14,5 cm, 5 <sup>3</sup> / <sub>4</sub> "	<b>75-1347-14</b>
15,0 cm, 6"	<b>75-1347-15</b>
16,0 cm, 6 <sup>1</sup> / <sub>4</sub> "	<b>75-1347-16</b>
18,0 cm, 7"	<b>75-1347-18</b>
20,0 cm, 8"	<b>75-1347-20</b>
25,0 cm, 10"	<b>75-1347-25</b>
30,0 cm, 12"	<b>75-1347-30</b>



fein  
fine  
finas  
fini

**STANDARD**

10,5 cm, 4 <sup>1</sup> / <sub>8</sub> "	<b>75-1348-10</b>
11,5 cm, 4 <sup>1</sup> / <sub>2</sub> "	<b>75-1348-11</b>
13,0 cm, 5"	<b>75-1348-13</b>
14,5 cm, 5 <sup>3</sup> / <sub>4</sub> "	<b>75-1348-14</b>
15,0 cm, 6"	<b>75-1348-15</b>
16,0 cm, 6 <sup>1</sup> / <sub>4</sub> "	<b>75-1348-16</b>
18,0 cm, 7"	<b>75-1348-18</b>
20,0 cm, 8"	<b>75-1348-20</b>
25,0 cm, 10"	<b>75-1348-25</b>
30,0 cm, 12"	<b>75-1348-30</b>

Anatomische Pinzetten  
Dissecting Forceps  
Pinzas de disección  
Pinze anatomiche per dissezione



fein  
fine  
finas  
fni



fein  
fine  
finas  
fni

mit Stift  
with pin  
con perno  
con espiga



schmal  
narrow  
estrechos  
stretti

10,5 cm, 4 <sup>1</sup> / <sub>8</sub> "	<b>75-1349-10</b>
11,5 cm, 4 <sup>1</sup> / <sub>2</sub> "	<b>75-1349-11</b>
13,0 cm, 5"	<b>75-1349-13</b>
14,5 cm, 5 <sup>3</sup> / <sub>4</sub> "	<b>75-1349-14</b>
16,0 cm, 6 <sup>1</sup> / <sub>4</sub> "	<b>75-1349-16</b>
18,0 cm, 7"	<b>75-1349-18</b>
20,0 cm, 8"	<b>75-1349-20</b>
25,0 cm, 10"	<b>75-1349-25</b>
30,0 cm, 12"	<b>75-1349-30</b>

10,5 cm, 4 <sup>1</sup> / <sub>8</sub> "	<b>75-1350-10</b>
11,5 cm, 4 <sup>1</sup> / <sub>2</sub> "	<b>75-1350-11</b>
13,0 cm, 5"	<b>75-1350-13</b>
14,5 cm, 5 <sup>3</sup> / <sub>4</sub> "	<b>75-1350-14</b>
16,0 cm, 6 <sup>1</sup> / <sub>4</sub> "	<b>75-1350-16</b>
18,0 cm, 7"	<b>75-1350-18</b>
20,0 cm, 8"	<b>75-1350-20</b>
25,0 cm, 10"	<b>75-1350-25</b>
30,0 cm, 12"	<b>75-1350-30</b>

MOD. USA	
12,0 cm, 4 <sup>3</sup> / <sub>4</sub> "	<b>75-1351-10</b>
13,0 cm, 5"	<b>75-1351-11</b>
14,5 cm, 5 <sup>3</sup> / <sub>4</sub> "	<b>75-1351-14</b>
15,0 cm, 6"	<b>75-1351-15</b>
18,0 cm, 7"	<b>75-1351-18</b>
20,0 cm, 8"	<b>75-1351-20</b>
25,5 cm, 10"	<b>75-1351-25</b>
30,0 cm, 12"	<b>75-1351-30</b>

MOD. USA	
12,0 cm, 4 <sup>3</sup> / <sub>4</sub> "	<b>75-1352-11</b>
13,0 cm, 5"	<b>75-1352-13</b>
14,5 cm, 5 <sup>3</sup> / <sub>4</sub> "	<b>75-1352-14</b>
15,0 cm, 6"	<b>75-1352-15</b>
18,0 cm, 7"	<b>75-1352-18</b>
20,0 cm, 8"	<b>75-1352-20</b>
25,5 cm, 10"	<b>75-1352-25</b>

**Anatomische Pinzetten**  
**Dissecting Forceps**  
**Pinzas de disección**  
**Pinze anatomiche per dissezione**



**ADSON**  
12,0 cm, 4<sup>3</sup>/<sub>4</sub>" **75-1353-12**  
15,0 cm, 6" **75-1353-15**



**MICRO-ADSON**  
12,0 cm, 4<sup>3</sup>/<sub>4</sub>" **75-1354-12**  
15,0 cm, 6" **75-1354-15**



**STILLE**  
15,0 cm, 6"  
**75-1355-15**



**MC INDOE**  
15,0 cm, 6"  
**75-1356-15**



**TAYLOR**  
17,5 cm, 6<sup>5</sup>/<sub>8</sub>"  
**75-1357-17**



**TAYLOR**  
17,5 cm, 6<sup>5</sup>/<sub>8</sub>"  
**75-1358-17**



**TAYLOR**  
18,5 cm, 7<sup>1</sup>/<sub>4</sub>"  
**75-1359-18**



**GERALD**  
18,0 cm, 7"  
**75-1360-18**

Anatomische Pinzetten  
Dissecting Forceps  
Pinzas de disección  
Pinze anatomiche per dissezione



**GERALD**  
18,0 cm, 7"  
**75-1361-18**



**POTTS-SMITH**  
18,0 cm, 7" **75-1362-18**  
21,0 cm, 8<sup>1</sup>/<sub>4</sub>" **75-1362-21**  
25,0 cm, 10" **75-1362-25**



**POTTS-SMITH**  
18,0 cm, 7" **75-1363-18**  
21,0 cm, 8<sup>1</sup>/<sub>4</sub>" **75-1363-21**  
25,0 cm, 10" **75-1363-25**



englische Modelle  
english patterns  
modelos ingleses  
modelli inglese

13,0 cm, 5" **75-1364-13**  
14,5 cm, 5<sup>3</sup>/<sub>4</sub>" **75-1364-14**  
15,0 cm, 6" **75-1364-15**



**SEMKEN**  
12,5 cm, 5" **75-1365-12**  
15,0 cm, 6" **75-1365-15**



**CUSHING**  
17,5 cm, 6<sup>5</sup>/<sub>8</sub>"  
**75-1366-17**



**CUSHING**  
17,5 cm, 6<sup>5</sup>/<sub>8</sub>"  
**75-1367-17**



20,0 cm, 8"  
**75-1368-20**

**Anatomische Pinzetten**  
**Dissecting Forceps**  
**Pinzas de disección**  
**Pinze anatomiche per dissezione**



**BROPHY**  
20,0 cm, 8"  
75-1369-20



**BONNEY**  
18,0 cm, 7"  
75-1370-18



**SINGLE-TUTTLE**  
23,0 cm, 9"  
75-1371-23



**DENNIS BROWN**  
20,0 cm, 8"  
75-1372-20



**DUEHRSEN**  
20,0 cm, 8"  
75-1373-20



**WAUGH**  
15,0 cm, 6"    **75-1374-15**  
20,0 cm, 8"    **75-1374-20**



**RAMSEY**  
18,0 cm, 7"  
75-1375-18

Chirurgische Pinzetten  
Tissue Forceps  
Pinzas quirúrgicas  
Pinze per chirurgia



STANDARD	
10,5 cm, 4 <sup>1</sup> / <sub>8</sub> "	<b>75-1376-10</b>
11,5 cm, 4 <sup>1</sup> / <sub>2</sub> "	<b>75-1376-11</b>
13,0 cm, 5"	<b>75-1376-13</b>
14,5 cm, 5 <sup>3</sup> / <sub>4</sub> "	<b>75-1376-14</b>
15,0 cm, 6"	<b>75-1376-15</b>
16,0 cm, 6 <sup>1</sup> / <sub>4</sub> "	<b>75-1376-16</b>
18,0 cm, 7"	<b>75-1376-18</b>
20,0 cm, 8"	<b>75-1376-20</b>
25,0 cm, 10"	<b>75-1376-25</b>
30,0 cm, 12"	<b>75-1376-30</b>



11,5 cm, 4 <sup>1</sup> / <sub>2</sub> "	<b>75-1377-11</b>
13,0 cm, 5"	<b>75-1377-13</b>
14,5 cm, 5 <sup>3</sup> / <sub>4</sub> "	<b>75-1377-14</b>
16,0 cm, 6 <sup>1</sup> / <sub>4</sub> "	<b>75-1377-16</b>
18,0 cm, 7"	<b>75-1377-18</b>
20,0 cm, 8"	<b>75-1377-20</b>
25,0 cm, 10"	<b>75-1377-25</b>
30,0 cm, 12"	<b>75-1377-30</b>



13,0 cm, 5"	<b>75-1378-13</b>
14,5 cm, 5 <sup>3</sup> / <sub>4</sub> "	<b>75-1378-14</b>
16,0 cm, 6 <sup>1</sup> / <sub>4</sub> "	<b>75-1378-16</b>
18,0 cm, 7"	<b>75-1378-18</b>
20,0 cm, 8"	<b>75-1378-20</b>



13,0 cm, 5"	<b>75-1379-13</b>
14,5 cm, 5 <sup>3</sup> / <sub>4</sub> "	<b>75-1379-14</b>
16,0 cm, 6 <sup>1</sup> / <sub>4</sub> "	<b>75-1379-16</b>
18,0 cm, 7"	<b>75-1379-18</b>
20,0 cm, 8"	<b>75-1379-20</b>

**Chirurgische Pinzetten**  
**Tissue Forceps**  
**Pinzas quirúrgicas**  
**Pinze per chirurgia**

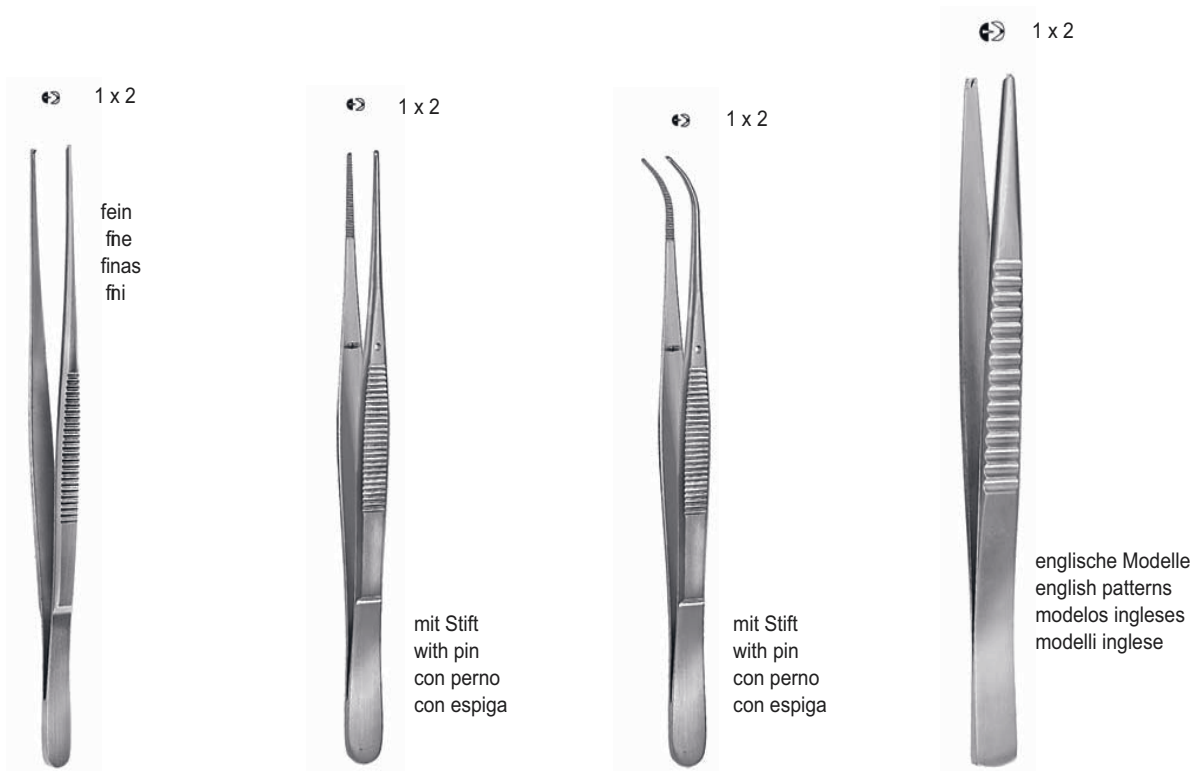

fein  
fne  
finas  
fni

mit Stift  
with pin  
con perno  
con espiga

mit Stift  
with pin  
con perno  
con espiga

englische Modelle  
english patterns  
modelos ingleses  
modelli inglese

13,0 cm, 5"	<b>75-1380-13</b>
14,5 cm, 5 <sup>3</sup> / <sub>4</sub> "	<b>75-1380-14</b>
15,5 cm, 6"	<b>75-1380-15</b>
16,0 cm, 6 <sup>1</sup> / <sub>4</sub> "	<b>75-1380-16</b>
18,0 cm, 7"	<b>75-1380-18</b>
20,0 cm, 8"	<b>75-1380-20</b>
25,0 cm, 10"	<b>75-1380-25</b>
30,0 cm, 12"	<b>75-1380-30</b>

13,0 cm, 5"	<b>75-1218-13</b>
14,5 cm, 5 <sup>3</sup> / <sub>4</sub> "	<b>75-1218-14</b>
15,5 cm, 6"	<b>75-1218-15</b>
16,0 cm, 6 <sup>1</sup> / <sub>4</sub> "	<b>75-1218-16</b>
18,0 cm, 7"	<b>75-1218-18</b>
20,0 cm, 8"	<b>75-1218-20</b>
25,0 cm, 10"	<b>75-1218-25</b>
30,0 cm, 12"	<b>75-121-30</b>

13,0 cm, 5"	<b>75-1219-13</b>
14,5 cm, 5 <sup>3</sup> / <sub>4</sub> "	<b>75-1219-14</b>
16,0 cm, 6 <sup>1</sup> / <sub>4</sub> "	<b>TF-1219-16</b>
18,0 cm, 7"	<b>75-1219-18</b>
20,0 cm, 8"	<b>75-1219-20</b>

13,0 cm, 5"	<b>75-1236-13</b>
14,5 cm, 5 <sup>3</sup> / <sub>4</sub> "	<b>75-1236-14</b>
15,0 cm, 6"	<b>75-1236-15</b>

Chirurgische Pinzetten  
Tissue Forceps  
Pinzas quirúrgicas  
Pinze per chirurgia



MOD. USA	
12,0 cm, 4 <sup>3</sup> / <sub>4</sub> "	<b>75-1384-12</b>
13,0 cm, 5"	<b>75-1384-13</b>
14,5 cm, 5 <sup>3</sup> / <sub>4</sub> "	<b>75-1384-14</b>
15,5 cm, 6"	<b>75-1384-15</b>
18,0 cm, 7"	<b>75-1384-18</b>
20,0 cm, 8"	<b>75-1384-20</b>
25,0 cm, 10"	<b>75-1384-25</b>
30,0 cm, 12"	<b>AK-1384-30</b>



MOD. USA	
12,0 cm, 4 <sup>3</sup> / <sub>4</sub> "	<b>75-1385-12</b>
13,0 cm, 5"	<b>75-1385-13</b>
14,5 cm, 5 <sup>3</sup> / <sub>4</sub> "	<b>75-1385-14</b>
15,5 cm, 6"	<b>75-1385-15</b>
18,0 cm, 7"	<b>75-1385-18</b>
20,0 cm, 8"	<b>75-1385-20</b>
25,0 cm, 10"	<b>75-1385-25</b>
30,0 cm, 12"	<b>AK-1385-30</b>



ADSON	
12,0 cm, 4 <sup>3</sup> / <sub>4</sub> "	<b>75-1386-12</b>
15,0 cm, 6"	<b>75-1386-15</b>



MICRO-ADSON	
12,0 cm, 4 <sup>3</sup> / <sub>4</sub> "	<b>75-1387-12</b>
15,0 cm, 6"	<b>75-1387-15</b>



Chirurgische Pinzetten  
Tissue Forceps  
Pinzas quirúrgicas  
Pinze per chirurgia



**ADSON**  
12,0 cm, 4<sup>3/4</sup>" **75-1388-12**  
15,0 cm, 6" **75-1388-15**



**ADSON-BROWN**  
12,0 cm, 4<sup>3/4</sup>" **75-1389-12**  
15,0 cm, 6" **75-1389-15**



**ADSON**  
12,0 cm, 4<sup>3/4</sup>" **75-1390-12**



**STILLE**  
15,0 cm, 6" **75-1391-15**



**STILLE**  
15,0 cm, 6" **75-1392-15**



**GILLIES**  
15,0 cm, 6" **75-1393-15**



**ADLERKREUTZ**  
15,0 cm, 6" **75-1394-15**  
20,0 cm, 8" **75-1394-20**



**ADLERKREUTZ**  
15,0 cm, 6" **75-1395-15**  
20,0 cm, 8" **75-1395-20**

Chirurgische Pinzetten  
Tissue Forceps  
Pinzas quirúrgicas  
Pinze per chirurgia

1 x 2



**SEMKEN**  
12,5 cm, 5" **75-1396-12**  
15,5 cm, 6" **75-1396-15**

2 x 3



**SEMKEN**  
12,5 cm, 5"  
**75-1397-12**

1 x 2



**MC INDOE**  
15,0 cm, 6"  
**75-1398-15**

1 x 2



**TAYLOR**  
17,5 cm, 6<sup>5</sup>/<sub>8</sub>"  
**75-1399-17**

1 x 2



**TAYLOR**  
17,5 cm, 6<sup>5</sup>/<sub>8</sub>"  
**75-1400-17**

1 x 2



**TAYLOR**  
17,5 cm, 6<sup>5</sup>/<sub>8</sub>"  
**75-1401-17**

1 x 2



**GERALD**  
18,0 cm, 7"  
**75-1402-18**

1 x 2



**GERALD**  
18,0 cm, 7"  
**75-1403-18**

Chirurgische Pinzetten  
Tissue Forceps  
Pinzas quirúrgicas  
Pinze per chirurgia



**CUSHING**  
17,5 cm, 6<sup>5</sup>/<sub>8</sub>"  
75-1404-17



**CUSHING**  
17,5 cm, 6<sup>5</sup>/<sub>8</sub>"  
75-1405-17



**POTTS-SMITH**  
18,0 cm, 7" **75-1406-18**  
21,0 cm, 8<sup>1</sup>/<sub>4</sub>" **75-1406-21**  
25,0 cm, 10" **75-1406-25**



**POTTS-SMITH**  
18,0 cm, 7" **75-1407-18**  
21,0 cm, 8<sup>1</sup>/<sub>4</sub>" **75-1407-21**  
25,0 cm, 10" **75-1407-25**



**WAUGH**  
15,0 cm, 6" **75-1408-15**  
20,0 cm, 8" **75-1408-20**



**BROPHY**  
20,0 cm, 8"  
75-1409-20



**BROPHY**  
20,0 cm, 8"  
75-1410-20



**RUSS. MODEL**  
15,0 cm, 6" **75-1411-15**  
20,0 cm, 8" **75-1411-20**  
25,0 cm, 10" **75-1411-25**

Chirurgische Pinzetten  
Tissue Forceps  
Pinzas quirúrgicas  
Pinze per chirurgia



**DURANTE**

14,5 cm, 5 <sup>3</sup> / <sub>4</sub> "	<b>75-1413-14</b>
16,0 cm, 6 <sup>1</sup> / <sub>4</sub> "	<b>75-1413-16</b>
20,0 cm, 8"	<b>75-1413-20</b>



**DUEHRSEN**

20,0 cm, 8"

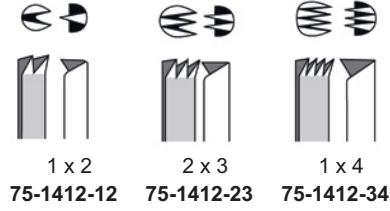

**NELSON**

15,0 cm, 6"	<b>75-1414-15</b>
20,0 cm, 8"	<b>75-1414-20</b>
23,0 cm, 9"	<b>75-1414-23</b>



**DUVAL**

14,0 cm, 5<sup>1</sup>/<sub>2</sub>"

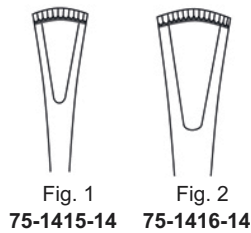

**COLLIN-DUVAL**

20,0 cm, 8"

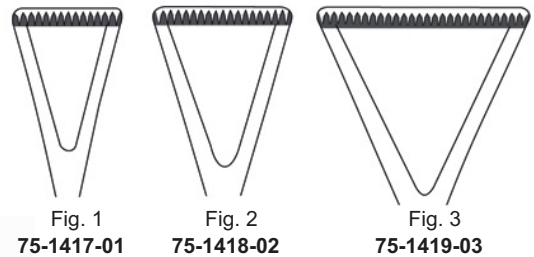

Chirurgische Pinzetten  
Tissue Forceps  
Pinzas quirúrgicas  
Pinze per chirurgia



**LANE**  
14,5 cm, 5<sup>3</sup>/<sub>4</sub>" **75-1420-14**  
20,0 cm, 8" **75-1420-20**



**LANE**  
14,5 cm, 5<sup>3</sup>/<sub>4</sub>" **75-1421-14**  
20,0 cm, 8" **75-1421-20**



**BROWN**  
15,0 cm, 6" **75-1422-15**  
20,0 cm, 8" **75-1422-20**  
25,0 cm, 10" **75-1422-25**



**TREVES**  
13,0 cm, 5" **75-1423-13**  
15,0 cm, 6" **75-1423-15**



**RAMSEY**  
18,0 cm, 7"  
**75-1424-18**



**RAMSEY**  
18,0 cm, 7"  
**75-1425-18**



**RAMSEY**  
18,0 cm, 7"  
**75-1426-18**



**RAMSEY**  
18,0 cm, 7"  
**75-1427-18**

Splitterpinzetten  
Splinter Forceps  
Pinzas para espinas  
Pinze per schegge

1 x 2



8,0 cm, 3<sup>1</sup>/<sub>4</sub>" **75-1428-08**  
9,0 cm, 3<sup>1</sup>/<sub>2</sub>" **75-1428-09**  
10,5 cm, 4<sup>1</sup>/<sub>8</sub>" **75-1428-10**  
11,5 cm, 4<sup>1</sup>/<sub>2</sub>" **75-1428-11**  
13,0 cm, 5" **75-1428-13**  
14,5 cm, 5<sup>1</sup>/<sub>2</sub>" **75-1428-14**



8,0 cm, 3<sup>1</sup>/<sub>4</sub>" **75-1429-08**  
9,0 cm, 3<sup>1</sup>/<sub>2</sub>" **75-1429-09**  
10,5 cm, 4<sup>1</sup>/<sub>8</sub>" **75-1429-10**  
11,5 cm, 4<sup>1</sup>/<sub>2</sub>" **75-1429-11**  
13,0 cm, 5" **75-1429-13**  
14,5 cm, 5<sup>1</sup>/<sub>2</sub>" **75-1429-14**



8,0 cm, 3<sup>1</sup>/<sub>4</sub>" **75-1430-08**  
9,0 cm, 3<sup>1</sup>/<sub>2</sub>" **75-1430-09**  
10,5 cm, 4<sup>1</sup>/<sub>8</sub>" **75-1430-10**  
11,5 cm, 4<sup>1</sup>/<sub>2</sub>" **75-1430-11**  
13,0 cm, 5" **75-1430-13**  
14,5 cm, 5<sup>1</sup>/<sub>2</sub>" **75-1430-14**



8,0 cm, 3<sup>1</sup>/<sub>4</sub>" **016-1431-08**  
9,0 cm, 3<sup>1</sup>/<sub>2</sub>" **016-1431-09**  
10,5 cm, 4<sup>1</sup>/<sub>8</sub>" **016-1431-10**  
11,5 cm, 4<sup>1</sup>/<sub>2</sub>" **016-1431-11**  
13,0 cm, 5" **016-1431-13**  
14,5 cm, 5<sup>1</sup>/<sub>2</sub>" **016-1431-14**

Splitterpinzetten, Mikro-Pinzetten  
Splinter Forceps, Micro Forceps  
Pinzas para espinas, Pinzas para microscopia  
Pinze per schegge, Pinze per microscopia



**HUNTER**  
10,5 cm, 4 1/4"  
75-1432-10



**HUNTER**  
10,5 cm, 4 1/4"  
75-1433-10



**WALTER-CARMALT**  
10,5 cm, 4 1/4"  
75-1434-10



**WALTER-CARMALT**  
10,5 cm, 4 1/4"  
75-1435-10



**FEILCHENFELD**  
7,5 cm, 3 1/8" **75-1436-07**  
9,0 cm, 3 1/2" **75-1436-09**  
11,5 cm, 4 1/2" **75-1436-11**



10,0 cm, 4"  
**75-1437-10**



10,0 cm, 4"  
**75-1438-10**



10,0 cm, 4"  
**75-1439-10**  
selbsthaltend  
glatt

Mikro-Pinzetten  
Micro Forceps  
Pinzas para microscopia  
Pinze per microscopia



**GRAEFE**  
10,0 cm, 4"  
75-1440-10



**GRAEFE**  
10,0 cm, 4"  
75-1441-10



**GRAEFE**  
10,0 cm, 4"  
75-1442-10



**GRAEFE**  
10,0 cm, 4"  
75-1443-10



**GRAEFE**  
10,0 cm, 4"  
75-1444-10



**GRAEFE**  
10,0 cm, 4"  
75-1445-10



**Uhrmacher Pinzetten, Gefäßdilatoren  
Jeweller's Forceps, Vessel Dilators  
Pinzas de relojería, Diladores vasculares  
Pinze per orologiaio, Dilatori vascolari**



Fig. 3  
11,5 cm, 4 1/2"  
75-1446-03

0,3 mm x 45°



Fig. 4  
11,5 cm, 4 1/2"  
75-1447-04

0,3 mm x 90°



Fig. 5  
11,5 cm, 4 1/2"  
75-1448-05

0,3 mm



Fig. 7  
11,5 cm, 4 1/2"  
75-1449-07

0,3 mm x 45°



11,0 cm, 4 3/8"  
75-1450-01

9 mm



11,0 cm, 4 3/8"  
75-1451-02

9 mm



11,0 cm, 4 3/8"  
75-1452-03

9 mm



11,0 cm, 4 3/8"  
75-1453-04

9 mm

diamantbeschichtet  
diamond coated  
diamantado  
diamantato

**Gefäßdilatoren, Atraumatische Pinzetten**  
**Vessel Dilators, Atraumatic Forceps**  
**Dilatadores vasculares, Pinzas atraumáticas**  
**Dilatatori vascolari, Pinze anatomiche atraumatica**

0,3 mm



9 mm

12,0 cm, 4<sup>3</sup>/<sub>4</sub>"  
75-1454-12

0,3 mm



9 mm

13,5 cm, 5<sup>3</sup>/<sub>8</sub>"  
75-1455-13

0,4 mm



9 mm

13,5 cm, 5<sup>3</sup>/<sub>8</sub>"  
75-1456-13

0,3 mm x 45°



9 mm

13,5 cm, 5<sup>3</sup>/<sub>8</sub>"  
75-1457-13



1,5 mm



2,0 mm



2,4 mm



2,8 mm



16,0 cm, 6 <sup>1</sup> / <sub>4</sub> "	75-1458-16	75-1459-16	75-1460-16	75-1461-16
20,0 cm, 8"	75-1458-20	75-1459-20	75-1460-20	75-1461-20
24,0 cm, 9 <sup>1</sup> / <sub>2</sub> "	75-1458-24	75-1459-24	75-1460-24	75-1461-24
30,0 cm, 12"	75-1458-30	75-1459-30	75-1460-30	75-1461-30

2,8 mm



3,5 mm



3,5 mm



16,0 cm, 6 <sup>1</sup> / <sub>4</sub> "	75-1462-16	75-1463-16	75-1464-16
20,0 cm, 8"	75-1462-20	75-1463-20	75-1464-20
24,0 cm, 9 <sup>1</sup> / <sub>2</sub> "	75-1462-24	75-1463-24	75-1464-24
30,0 cm, 12"	75-1462-30	75-1463-30	75-1464-30



1,5 mm



2,0 mm



16,0 cm, 6 <sup>1</sup> / <sub>4</sub> "	75-1465-16	75-1466-16
20,0 cm, 8"	75-1465-20	75-1466-20
24,0 cm, 9 <sup>1</sup> / <sub>2</sub> "	75-1465-24	75-1466-24
30,0 cm, 12"	75-1465-30	75-1466-30

DE BAKEY

DE BAKEY

Pinzetten mit Hartmetalleinlagen  
 Forceps with tungsten carbide inserts  
 Pinzas con bocas de carburo tungsteno  
 Pinze con morsi in carburo di tungsteno



STANDARD	
14,5 cm, 5 <sup>3</sup> / <sub>4</sub> "	<b>AK-1467-14</b>
16,0 cm, 6 <sup>1</sup> / <sub>4</sub> "	<b>75-1467-16</b>
18,0 cm, 7"	<b>75-1467-18</b>
20,0 cm, 8"	<b>75-1467-20</b>
25,0 cm, 10"	<b>75-1467-25</b>
30,0 cm, 12"	<b>75-1467-30</b>

STANDARD	
14,0 cm, 5 <sup>1</sup> / <sub>2</sub> "	<b>75-1468-14</b>
16,0 cm, 6 <sup>1</sup> / <sub>4</sub> "	<b>75-1468-16</b>
18,0 cm, 7"	<b>75-1468-18</b>
20,0 cm, 8"	<b>75-1468-20</b>
25,0 cm, 10"	<b>75-1468-25</b>
30,0 cm, 12"	<b>75-1468-30</b>

STANDARD	
12,5 cm, 5"	<b>75-1469-12</b>
15,0 cm, 6"	<b>75-1469-15</b>

STANDARD	
15,0 cm, 6"	<b>75-1470-15</b>
23,0 cm, 9"	<b>75-1470-23</b>
25,0 cm, 10"	<b>75-1470-25</b>

Pinzetten mit Hartmetalleinlagen  
Forceps with tungsten carbide inserts  
Pinzas con bocas de carburo tungsteno  
Pinze con morsi in carburo di tungsteno



**GILLIES**  
15,0 cm, 6"  
75-1471-15



**MC INDOE**  
15,0 cm, 6"  
AK-1472-15



**GERALD**  
17,0 cm, 6<sup>3</sup>/<sub>4</sub>"



**POTTS-SMITH**  
15,0 cm, 6" **AK-1473-15**  
18,0 cm, 7" **AK-1473-18**  
20,0 cm, 8" **AK-1473-20**

75-1474-17

75-1475-17



**BONNEY**  
17,5 cm, 6<sup>5</sup>/<sub>8</sub>"  
75-1476-17



**CUSHING**  
17,5 cm, 6<sup>5</sup>/<sub>8</sub>"

75-1477-17

75-1478-17



**CUSHING-TAYLOR**  
18,0 cm, 7"  
75-1482-18



**ADSON**  
17,5 cm, 6<sup>5</sup>/<sub>8</sub>"

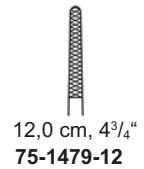

12,0 cm, 4<sup>3</sup>/<sub>4</sub>"  
75-1479-12

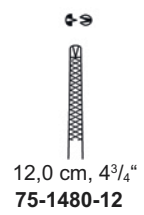

12,0 cm, 4<sup>3</sup>/<sub>4</sub>"  
75-1480-12

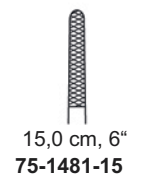

15,0 cm, 6"  
75-1481-15

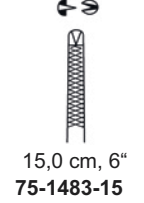

15,0 cm, 6"  
75-1483-15



**Tuch-, Schlauchklemmen, Tupferzangen**

**Towel Clamps, Sponge and Dressing Forceps, Tubing Clamps**

**Pinzas de campo, Pinzas para vendajes y torundas y para tubos**

**Pinze per fissare le compresse, per medicatura e tamponi, e per tubi**

Tuchklemmen  
Towel Clamps  
Pinzas de campo  
Pinze per fissare le compresse



**SCHAEDEL**  
9,0 cm, 3 1/2"  
75-1484-09



**ENGL. MODELL**  
9,0 cm, 3 1/2"  
75-1485-09



**JONES**

5,0 cm, 2"	<b>75-1486-05</b>
7,0 cm, 2 3/4"	<b>75-1486-07</b>
9,0 cm, 3 1/2"	<b>75-1486-09</b>



**JONES**  
9,0 cm, 3 1/2"  
75-1487-09

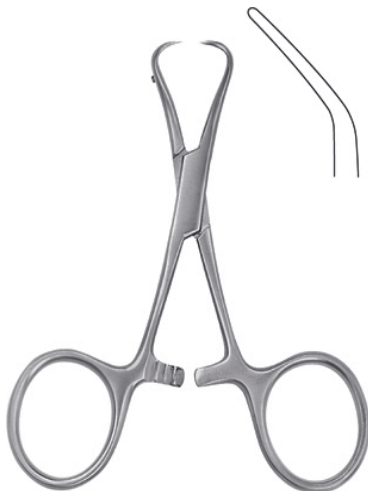

**BACKHAUS**

9,0 cm, 3 1/2"	<b>75-1488-09</b>
11,0 cm, 4 3/8"	<b>75-1488-11</b>
13,0 cm, 5"	<b>75-1488-13</b>
15,0 cm, 6"	<b>75-1488-15</b>



mit Schlauch- oder Kabelhalter  
with clip for tubing or cable  
con porta-tubo o porta-cable  
con porta-tubo o porta-cavo

11,0 cm, 4 3/8"  
75-1489-11



**ROEDER**  
13,0 cm, 5"  
75-1490-13

Tuchklemmen  
Towel Clamps  
Pinzas de campo  
Pinze per fissare le compresse



**ROEDER**  
15,0 cm, 5"  
75-1491-15



**BERNHARD**  
16,5 cm, 6½"  
75-1492-16

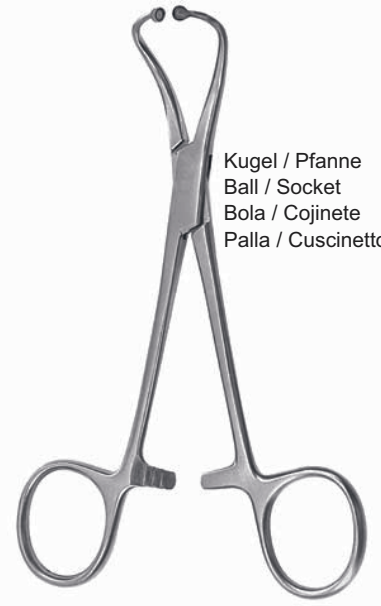

Kugel / Pfanne  
Ball / Socket  
Bola / Cojinete  
Palla / Cuscinetto

13,0 cm, 5"  
75-1493-13

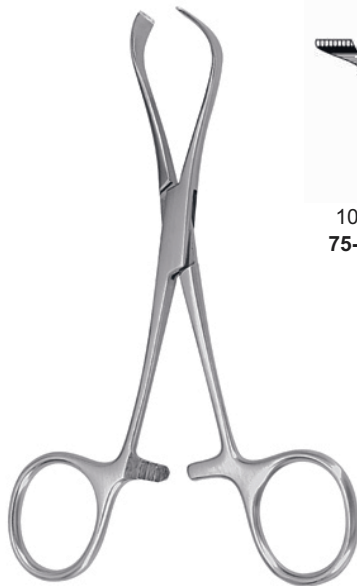

**LORNA**



10,0 cm, 4" 75-1494-10    13,0 cm, 5" 75-1494-13



**LANE**  
15,0 cm, 6" 75-1495-15  
18,0 cm, 7" 75-1495-18  
20,0 cm, 8" 75-1495-20

Tuchklemmen, Korn- und Tupferzangen  
Towel Clamps, Sponge and Dressing Forceps  
Pinzas de campo, Pinzas para vendajes y torundas  
Pinze per fissare le compresse, Pinze per medicatura e tamponi



**TOHOKU**

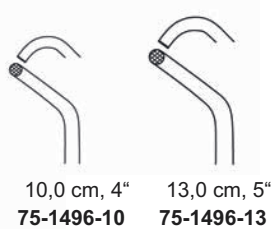

**PEERS**  
14,5 cm, 5<sup>3</sup>/<sub>4</sub>"  
75-1497-14



**LISTER**  
13,0 cm, 5" 75-1498-13  
16,0 cm, 6<sup>1</sup>/<sub>4</sub>" 75-1498-16  
18,0 cm, 7" 75-1498-18



**BRYANT**  
13,0 cm, 5"  
75-1499-13

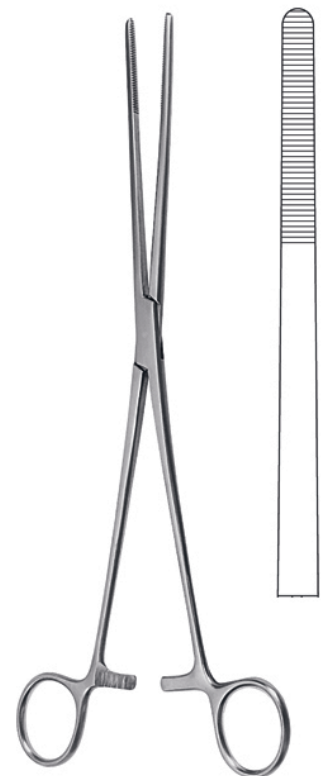

**BOZEMANN**  
26,0 cm, 10<sup>1</sup>/<sub>4</sub>"  
75-1500-26



**Korn- und Tupferzangen**  
**Sponge and Dressing Forceps**  
**Pinzas para vendajes y torundas**  
**Pinze per medicatura e tamponi**

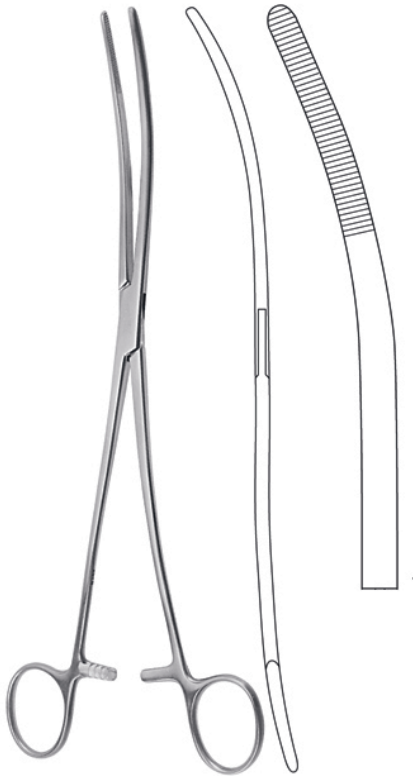

**BOZEMANN**  
26,0 cm, 10<sup>1</sup>/<sub>4</sub>"  
75-1501-26



**COLLIN**  
25,0 cm, 9<sup>3</sup>/<sub>4</sub>"  
75-1502-25



**CHERON**  
25,0 cm, 9<sup>3</sup>/<sub>4</sub>"  
75-1503-25



**PERLMANN**  
25,0 cm, 9<sup>3</sup>/<sub>4</sub>"

75-1504-25

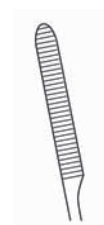

75-1505-25



**ULRICH**

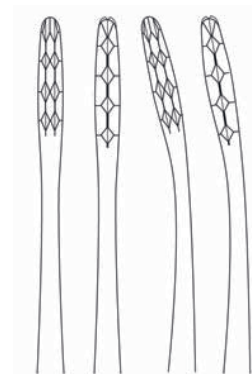

22,0 cm, 8 <sup>5</sup> / <sub>8</sub> "	<b>75-1506-22</b>	<b>AK-1507-22</b>
25,0 cm, 9 <sup>3</sup> / <sub>4</sub> "	<b>AK-1506-22</b>	<b>AK-1507-25</b>
27,0 cm, 10 <sup>5</sup> / <sub>8</sub> "	<b>AK-1506-22</b>	<b>AK-1507-27</b>

**Korn- und Tupferzangen**  
**Sponge and Dressing Forceps**  
**Pinzas para vendajes y torundas**  
**Pinze per medicatura e tamponi**



20,0 cm, 8"	<b>75-1508-20</b>	<b>75-1509-20</b>
22,0 cm, 8 <sup>5</sup> / <sub>8</sub> "	<b>75-1508-22</b>	<b>75-1509-22</b>
25,0 cm, 9 <sup>3</sup> / <sub>4</sub> "	<b>75-1508-25</b>	<b>75-1509-25</b>
27,0 cm, 10 <sup>5</sup> / <sub>8</sub> "	<b>AK-1508-22</b>	<b>AK-1509-27</b>

**GROSS-MAIER**



25,0 cm, 9<sup>3</sup>/<sub>4</sub>"  
**75-1510-25**

25,0 cm, 9<sup>3</sup>/<sub>4</sub>"  
**75-1511-25**

**FOERSTER**



18,0 cm, 7"	<b>AK-1512-18</b>	<b>AK-1513-18</b>	<b>75-1514-18</b>	<b>75-1515-18</b>
20,0 cm, 8"	<b>AK-1512-20</b>	<b>AK-1513-20</b>	<b>75-1514-20</b>	<b>AK-1515-20</b>
25,0 cm, 9 <sup>3</sup> / <sub>4</sub> "	<b>75-1512-25</b>	<b>75-1513-25</b>	<b>75-1514-25</b>	<b>75-1515-25</b>

**FOERSTER-BALLEGER**



**RAMPLEY**  
18,0 cm, 7" **75-1516-18**  
25,0 cm, 9<sup>3</sup>/<sub>4</sub>" **75-1516-25**

Schlauchklemmen  
Tubing Clamps  
Pinzas para tubos  
Pinze per tubi

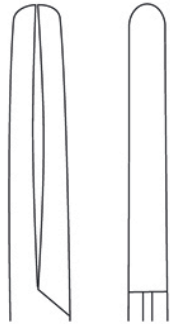

**PRESBYTERIAN**



16,5 cm, 6 <sup>1</sup> / <sub>2</sub> "	75-1517-16
18,0 cm, 7"	75-1517-18
20,0 cm, 8"	75-1517-20





**BERLIN**

14,5 cm, 5 <sup>3</sup> / <sub>4</sub> "	75-1518-14
--	------------



		
15,0 cm, 6"	18,0 cm, 7"	20,0 cm, 8"
75-1519-15	75-1519-18	75-1519-20



		
15,0 cm, 6"	18,0 cm, 7"	20,0 cm, 8"
75-1520-15	75-1520-18	75-1520-20

**MIT BÜGEL**



**Klemmen**

**Forceps**

**Pinas**

**Pinze**

Bulldogklemmen  
Bulldog Clamps  
Clamps Bulldog  
Pinze Bulldog



3,5 cm, 1 1/2"	<b>75-1521-03</b>	<b>75-1522-03</b>
5,0 cm, 2"	<b>75-1521-05</b>	<b>75-1522-05</b>



**DIEFFENBACH**



**HESS**  
75-1523-01



**HESS**  
75-1524-02



3,8 cm, 1 1/2"	<b>75-1525-04</b>	<b>75-1526-04</b>
5,0 cm, 2"	<b>75-1525-05</b>	<b>75-1526-05</b>
6,3 cm, 2 1/2"	<b>75-1525-06</b>	<b>75-1526-06</b>
7,6 cm, 3"	<b>75-1525-07</b>	<b>75-1526-07</b>
9,0 cm, 3 1/2"	<b>75-1525-09</b>	<b>75-1526-09</b>

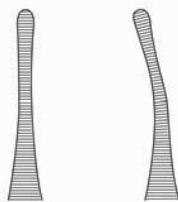

**JOHNS-HOPKINS**



**JOHNS-HOPKINS**  
23,0 cm, 9"  
75-1527-23

**Bulldogklemmen**  
**Bulldog Clamps**  
**Clamps Bulldog**  
**Pinze Bulldog**



mit atraumatischer Riefung  
with non-traumatic serration  
con bocas atraumáticas  
con presa atraumatica

		L	
7,5 cm, 3"	<b>75-1528-07</b>	2,5 cm, 1"	
8,5 cm, 3 1/4"	<b>75-1528-08</b>	3,5 cm, 1 3/8"	
10,5 cm, 4 1/8"	<b>AK-1528-10</b>	5,0 cm, 2"	
12,0 cm, 4 3/4"	<b>AK-1528-12</b>	6,8 cm, 2 3/4"	

**DE BAKEY**



mit atraumatischer Riefung  
with non-traumatic serration  
con bocas atraumáticas  
con presa atraumatica

		L	
7,0 cm, 2 3/4"	<b>75-1529-07</b>	2,5 cm, 1"	
8,0 cm, 3 1/8"	<b>75-1529-08</b>	3,5 cm, 1 3/8"	
10,0 cm, 3 3/4"	<b>75-1529-10</b>	5,0 cm, 2"	
11,5 cm, 4 1/2"		6,8 cm, 2 3/4"	

**DE BAKEY**



**TITANIUM**  
3,5 cm, 1 3/8"  
vena **75-1530-35**  
arteria **AK-1531-35**



**TITANIUM**  
3,5 cm, 1 3/8"  
vena **75-1532-35**  
arteria **75-1533-35**



**TITANIUM**  
4,0 cm, 1 5/8"  
vena **75-1534-40**  
arteria **75-1535-40**



**TITANIUM**  
4,0 cm, 1 5/8"  
vena **75-1536-40**  
arteria **75-1537-40**

**Bulldogklemmen, Darm- und Gewebefäßzangen**  
**Bulldog Clamps, Intestinal and Tissue Grasping Forceps**  
**Clamps Bulldog, Pinzas intestinales y para tejidos**  
**Pinze Bulldog, Pinze da presa per intestino e tessuti**

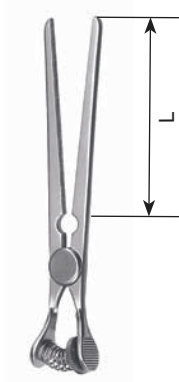

		L	
6,8 cm, 2 <sup>3</sup> / <sub>4</sub> "	<b>75-1538-07</b>	3,3 cm, 1 <sup>3</sup> / <sub>8</sub> "	
9,6 cm, 3 <sup>3</sup> / <sub>4</sub> "	<b>75-1538-09</b>	5,0 cm, 2"	
11,7 cm, 4 <sup>3</sup> / <sub>4</sub> "	<b>75-1538-11</b>	6,9 cm, 2 <sup>3</sup> / <sub>4</sub> "	

**GLOVER**

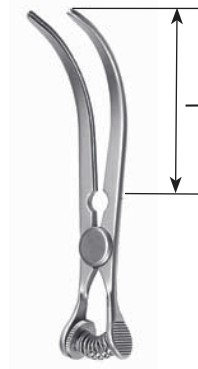

		L	
6,5 cm, 2 <sup>1</sup> / <sub>2</sub> "	<b>AK-1539-06</b>	3,3 cm, 1 <sup>3</sup> / <sub>8</sub> "	
9,1 cm, 3 <sup>1</sup> / <sub>2</sub> "	<b>75-1539-09</b>	5,0 cm, 2"	
11,0 cm, 4 <sup>3</sup> / <sub>8</sub> "	<b>75-1539-11</b>	6,9 cm, 2 <sup>3</sup> / <sub>4</sub> "	

**GLOVER**



**CHAPUT**  
 13,0 cm, 5"  
**75-1540-13**



**TUFFIER**  
 13,0 cm, 5"  
**75-1541-13**



**COLLIN**  
 16,0 cm, 6<sup>1</sup>/<sub>4</sub>"  
**75-1542-16**

Darm- und Gewebefäßzangen  
Intestinal and Tissue Grasping Forceps  
Pinzas intestinales y para tejidos  
Pinze da presa per intestino e tessuti



**PENNINGTON**

15,5 cm, 6"	<b>75-1543-15</b>
20,0 cm, 8"	<b>75-1543-20</b>



**ATRAUMA**



25,0 cm, 9<sup>3</sup>/<sub>4</sub>"  
**75-1544-25**



27,0 cm, 10<sup>1</sup>/<sub>2</sub>"  
**75-1544-27**

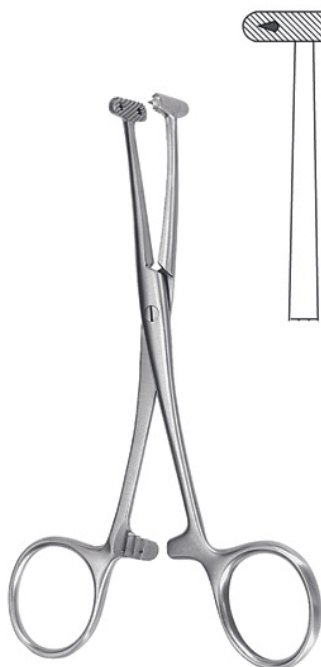

**MARTEL**

14,0 cm, 5<sup>1</sup>/<sub>2</sub>"  
**75-1545-14**

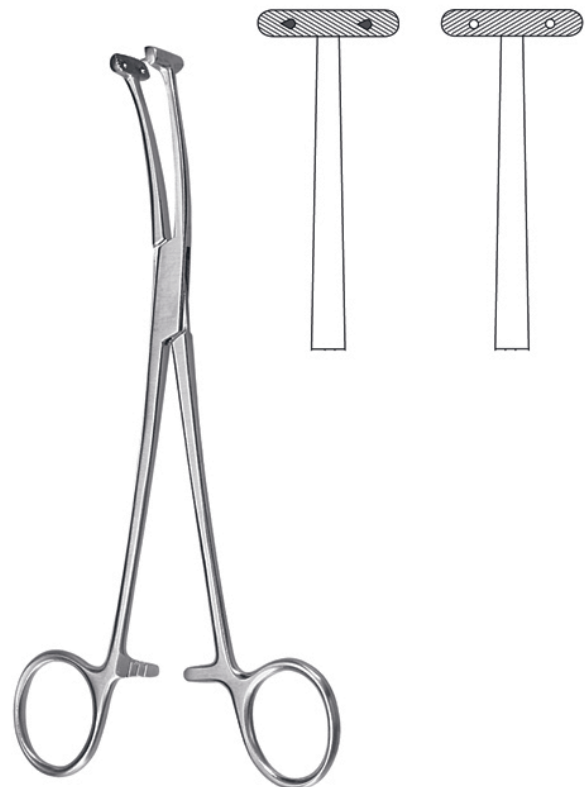

**WILLET-MARTEL**

19,0 cm, 7<sup>1</sup>/<sub>2</sub>"  
**75-1546-19**



Arterienklemmen  
Haemostatic Forceps  
Pinzas hemostáticas  
Pinze emostatiche



**PRATT**  
15,0 cm, 6"  
75-1549-15



**FERGUSSON**

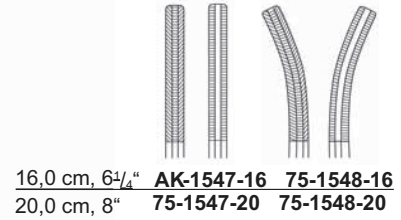

**CARREL**  
10,0 cm, 4"  
75-1550-10



**TERRIER**  
10,0 cm, 4"  
75-1551-10



**KROENLEIN**  
13,0 cm, 5"  
75-1552-13

Arterienklemmen  
Haemostatic Forceps  
Pinzas hemostáticas  
Pinze emostatiche



**PEAN**

14,0 cm, 5 1/2"	<b>75-1555-14</b>
16,0 cm, 6 1/4"	<b>75-1555-16</b>



**BABY-MIXTER**

14,0 cm, 5 1/2"

75-1553-01

75-1554-02



**SPENCER-WELLS**

13,0 cm, 5"	<b>75-1556-13 AK -1557-13</b>
15,0 cm, 6"	<b>AK-1556-15 AK -1557-15</b>
18,0 cm, 7"	<b>AK-1556-18 AK -1557-18</b>
20,0 cm, 8"	<b>75-1556-20 75-1557-20</b>



**HARTMANN**

10,0 cm, 4"

75-1558-10

75-1559-10

Arterienklemmen  
Haemostatic Forceps  
Pinzas hemostáticas  
Pinze emostatiche

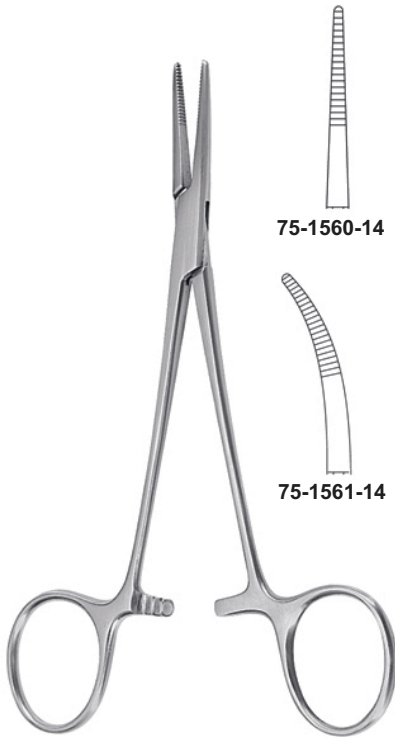

75-1560-14

75-1561-14

**PROVINCENCE-HOSPITAL**  
14,0 cm, 5 1/2"



12,5 cm, 5" **75-1562-12** **75-1563-12**  
25,0 cm, 9 3/4" **75-1562-14** **75-1563-14**

1 x 2 1 x 2  
12,5 cm, 5" **75-1564-12** **75-1565-12**  
25,0 cm, 9 3/4" **75-1564-14** **75-1565-14**

**HALSTED-MOSQUITO**



**HALSTED-MOSQUITO**



18,0 cm, 7"  
**75-1565-18**



18,0 cm, 7"  
**75-1566-18**



21,0 cm, 8 1/4"  
**75-1567-21**



21,0 cm, 8 1/4"  
**75-1568-21**

1 x 2  



18,0 cm, 7"  
**75-1569-18**

1 x 2  

18,0 cm, 7"  
**75-1570-18**

1 x 2  

21,0 cm, 8 1/4"  
**75-1571-21**

1 x 2  

21,0 cm, 8 1/4"  
**75-1572-21**

Arterienklemmen  
Haemostatic Forceps  
Pinzas hemostáticas  
Pinze emostatiche



		1 x 2	1 x 2
10,0 cm, 4"	<b>75-1573-10</b>	<b>75-1574-10</b>	<b>75-1575-10</b> <b>75-1576-10</b>
12,0 cm, 4 <sup>3</sup> / <sub>4</sub> "	<b>75-1573-12</b>	<b>75-1574-12</b>	<b>75-1575-12</b> <b>75-1576-12</b>

**MICRO-MOSQUITO**

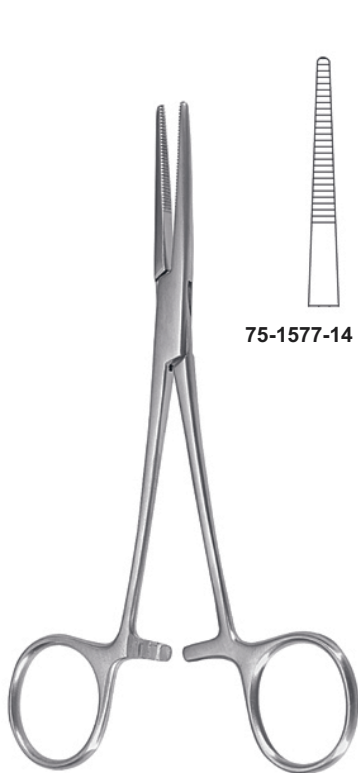

**75-1577-14**

**KELLY**  
14,0 cm, 5<sup>1</sup>/<sub>2</sub>"



**75-1578-14**

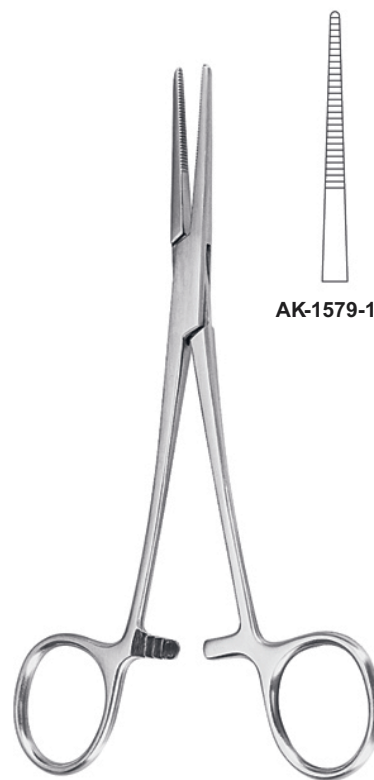

**KELLY-RANKIN**  
16,0 cm, 6<sup>1</sup>/<sub>4</sub>"

**AK-1579-16**

**75-1580-16**

Arterienklemmen  
Haemostatic Forceps  
Pinzas hemostáticas  
Pinze emostatiche



**LERICHE**  
15,0 cm, 6"



75-1581-15



75-1582-15

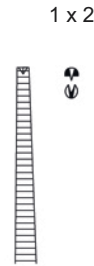

75-1583-15

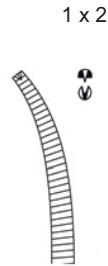

75-1584-15



**BABY-OVERHOLT**  
13,5 cm, 5 1/4"  
75-1585-14

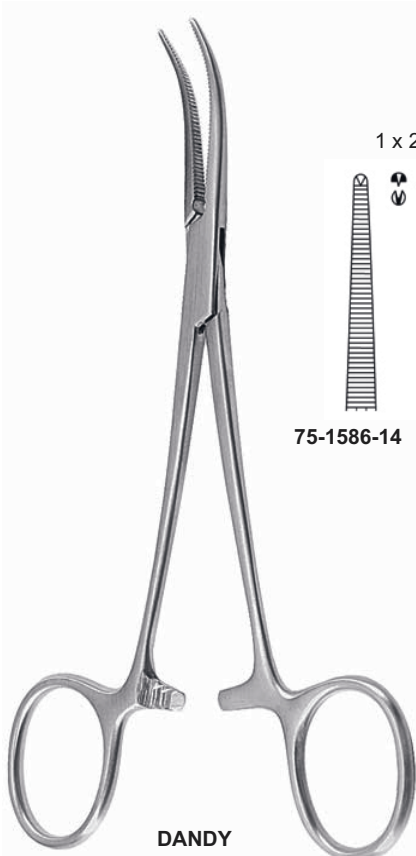

**DANDY**  
14,0 cm, 5 1/2"



75-1586-14



**CRILE**



75-1587-14



75-1588-14

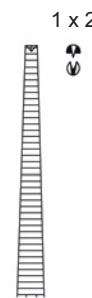

75-1589-14

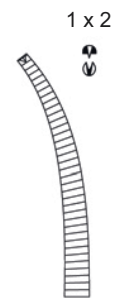

75-1590-14

14,0 cm, 5 1/2"

Arterienklemmen  
Haemostatic Forceps  
inzas hemostáticas  
Pinze emostatiche

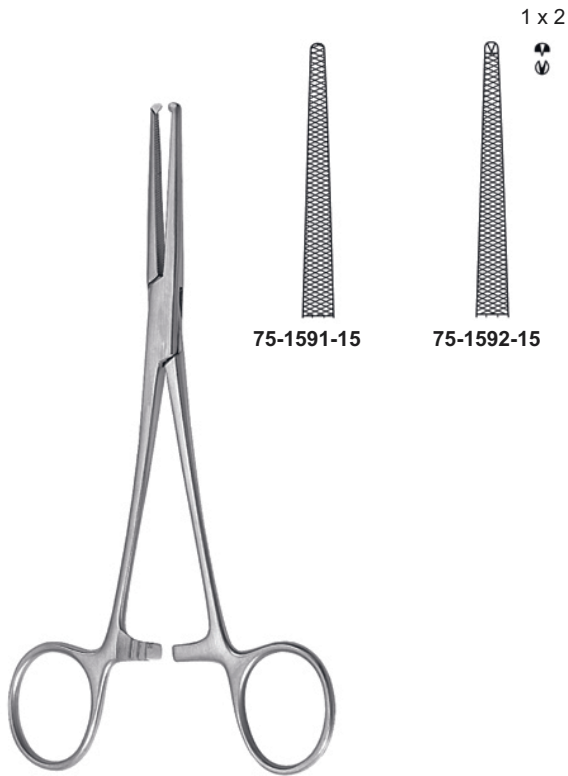

**DIXON-LOVELACE**  
15,0 cm, 6"

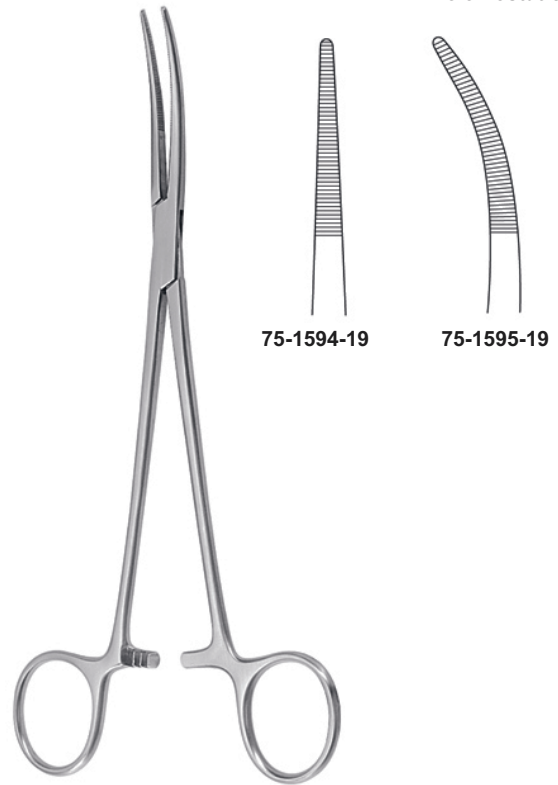

**BIRKETT**  
19,0 cm, 7 1/2"



**CRILE-RANKIN**  
16,0 cm, 6 1/4"

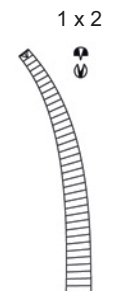
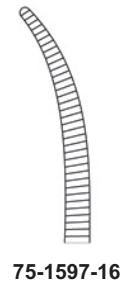
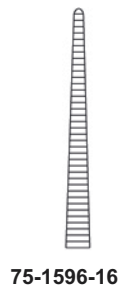

Arterienklemmen  
Haemostatic Forceps  
Pinzas hemostáticas  
Pinze emostatiche



75-1600-19



75-1601-19



75-1602-19

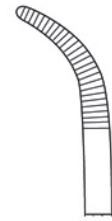

75-1603-19

**SCHNIDT**  
19,0 cm, 7 1/2"

**SCHNITZ-SAWTELL**  
19,0 cm



**ADSON**  
18,5 cm, 7 1/4"



75-1604-16



75-1605-16

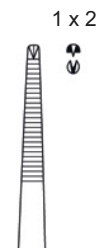

75-1606-16

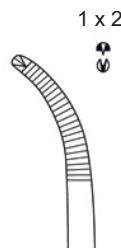

75-1607-16

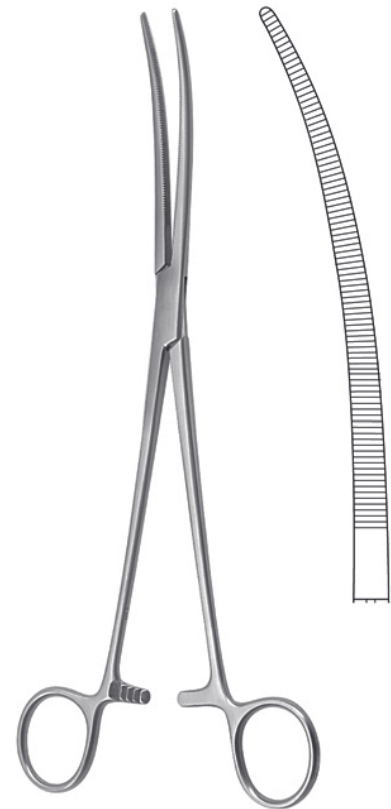

**CRAFOORD**  
24,0 cm, 9 1/2"  
75-1608-24

Arterienklemmen  
Haemostatic Forceps  
Pinzas hemostáticas  
Pinze emostatiche



15,0 cm, 6" **75-1609-15 75-1610-15**  
18,5 cm, 7 1/4" **75-1609-18 75-1610-18**

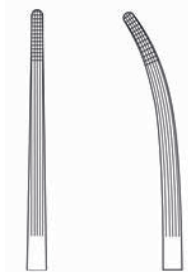

**BAINBRIDGE**



16,0 cm, 6 1/4" **75-1611-16 75-1612-16**  
20,0 cm, 8" **75-1611-20 75-1612-20**

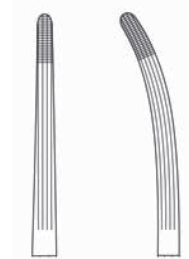

**ROCHESTER-CARMALT**



13,0 cm, 5" **75-1613-13 75-1614-13**  
14,0 cm, 5 1/2" **75-1613-14 75-1614-14**  
16,0 cm, 6 1/4" **75-1613-16 75-1614-16**

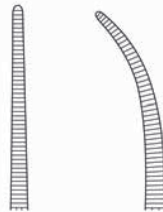

**PEAN DELICATE**



13,0 cm, 5" **75-1615-13 75-1616-13**  
14,0 cm, 5 1/2" **75-1615-14 75-1616-14**  
16,0 cm, 6 1/4" **75-1615-16 75-1616-16**

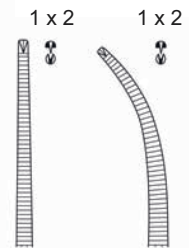

**KOCHER DELICATE**



Arterienklemmen  
Haemostatic Forceps  
Pinzas hemostáticas  
Pinze emostatiche

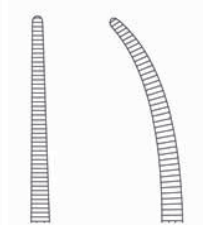

14,0 cm, 5½"	75-1617-14	75-1618-14
16,0 cm, 6¼"	75-1617-16	75-1618-16
18,0 cm, 7"	75-1617-18	75-1618-18
20,0 cm, 8"	75-1617-20	75-1618-20
22,0 cm, 8⅝"	75-1617-22	75-1618-22
24,0 cm, 9½"	75-1617-24	75-1618-24
26,0 cm, 10¼"	75-1617-26	75-1618-26
30,0 cm, 12"	75-1617-30	75-1618-30

ROCHESTER-PEAN

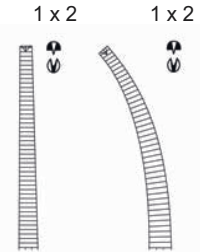
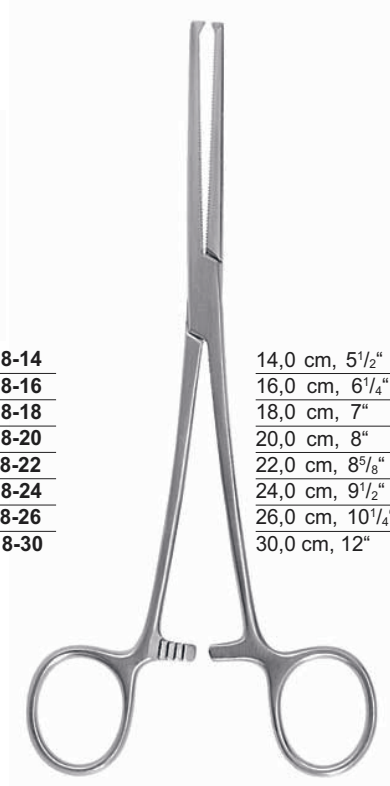

14,0 cm, 5½"	75-1619-14	75-1620-14
16,0 cm, 6¼"	75-1619-16	75-1620-16
18,0 cm, 7"	75-1619-18	75-1620-18
20,0 cm, 8"	75-1619-20	75-1620-20
22,0 cm, 8⅝"	75-1619-22	75-1620-22
24,0 cm, 9½"	75-1619-24	75-1620-24
26,0 cm, 10¼"	75-1619-26	75-1620-26
30,0 cm, 12"	75-1619-30	75-1620-30

KOCHER-OCHSNER

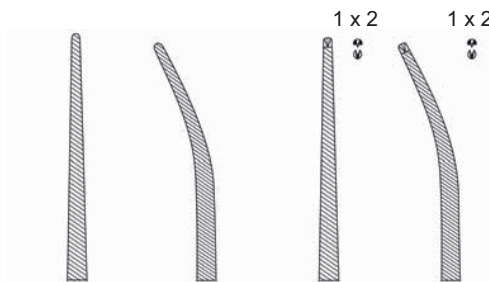

20,0 cm, 8"	75-1621-20	75-1622-20	75-1623-20	75-1624-20
26,0 cm, 10¼"	75-1621-26	75-1622-26	75-1623-26	75-1624-26

BENGOLEA

Arterienklemmen  
Haemostatic Forceps  
Pinzas hemostáticas  
Pinze emostatiche

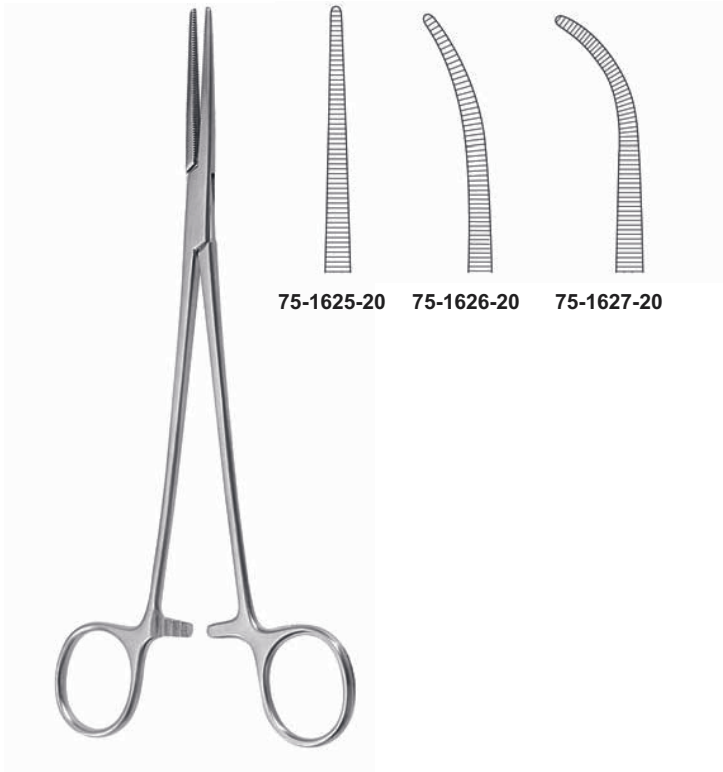

**HEISS**  
20,0 cm, 8"

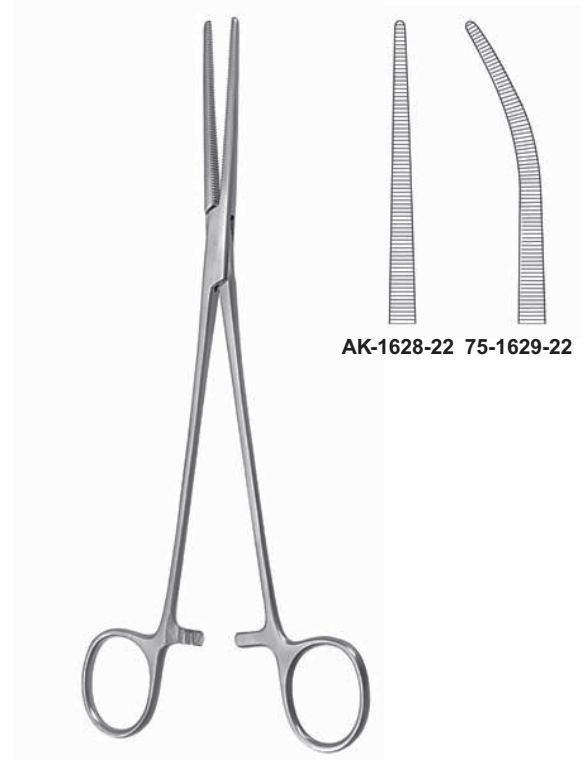

**ROBERTS**  
22,0 cm, 8<sup>5</sup>/<sub>8</sub>"



**SAROT**  
24,0 cm, 9<sup>1</sup>/<sub>2</sub>"



**NEGUS**  
19,0 cm, 7<sup>1</sup>/<sub>2</sub>"

**Präparier- und Ligaturklemmen**  
**Dissecting and Ligature Forceps**  
**Pinzas de disección y ligaduras**  
**Pinze per preparazioni e legature**



14,0 cm, 5½" 75-1634-14  
18,0 cm, 7" 75-1635-18

**BABY-ADSON**



**MICRO-ADSON**  
14,0 cm, 5½"  
75-1636-14



**BABY-MIXTER**  
18,0 cm, 7"  
75-1637-18



**OVERHOLT-MIXTER**  
21,0 cm, 8¼"  
75-1638-21



**JOHNS HOPKINS**  
20,0 cm, 8"  
75-1639-20

Präparier- und Ligaturklemmen  
Dissecting and Ligature Forceps  
Pinzas de disección y ligaduras  
Pinze per preparazioni e legature



**OVERHOLT**

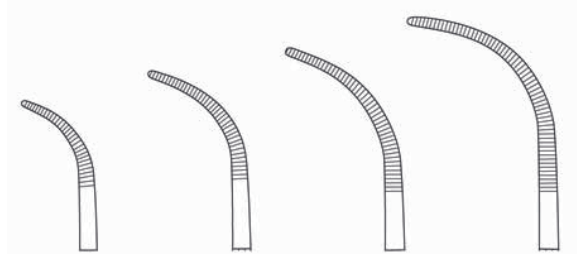

18,5 cm, 7<sup>1</sup>/<sub>4</sub>"  
**75-1640-01**

20,0 cm, 8"  
**75-1640-02**

21,0 cm, 8<sup>1</sup>/<sub>4</sub>"  
**75-1640-03**

21,5 cm, 8<sup>1</sup>/<sub>2</sub>"  
**75-1640-04**



**RUMEL**  
23,0 cm, 9"

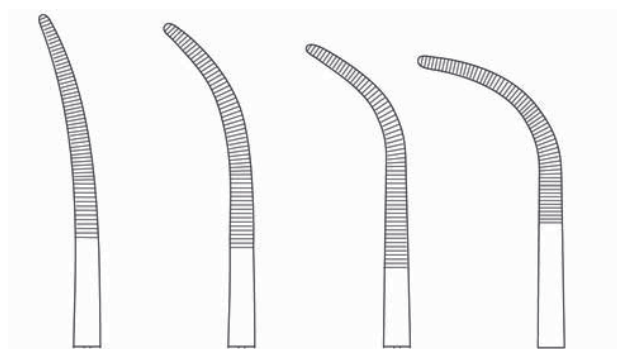

**AK-1641-01**

**AK-1641-02**

**AK-1641-03**

**75-1641-04**

**Präparier- und Ligaturklemmen**  
**Dissecting and Ligature Forceps**  
**Pinzas de disección y ligaduras**  
**Pinze per preparazioni e legature**



**OVERHOLT-GEISSENDOERFER**

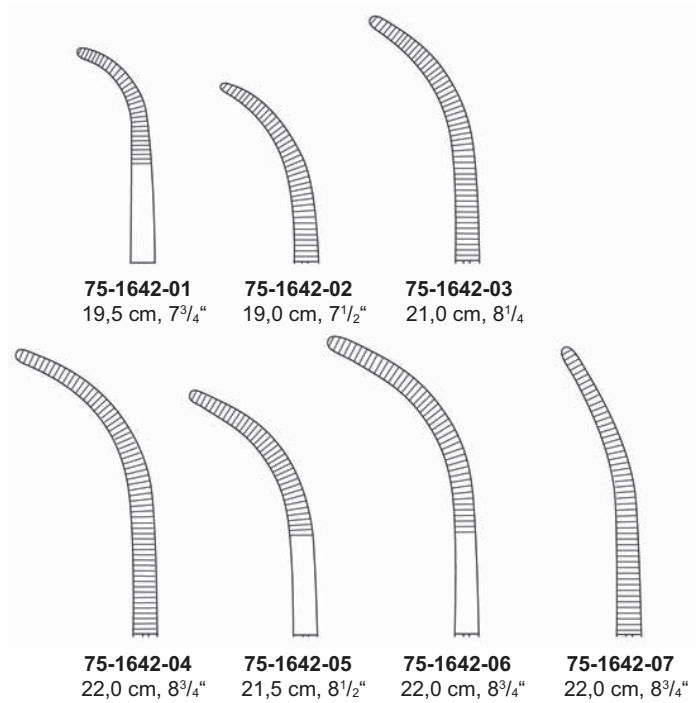

**OVERHOLT-GEISSENDOERFER**

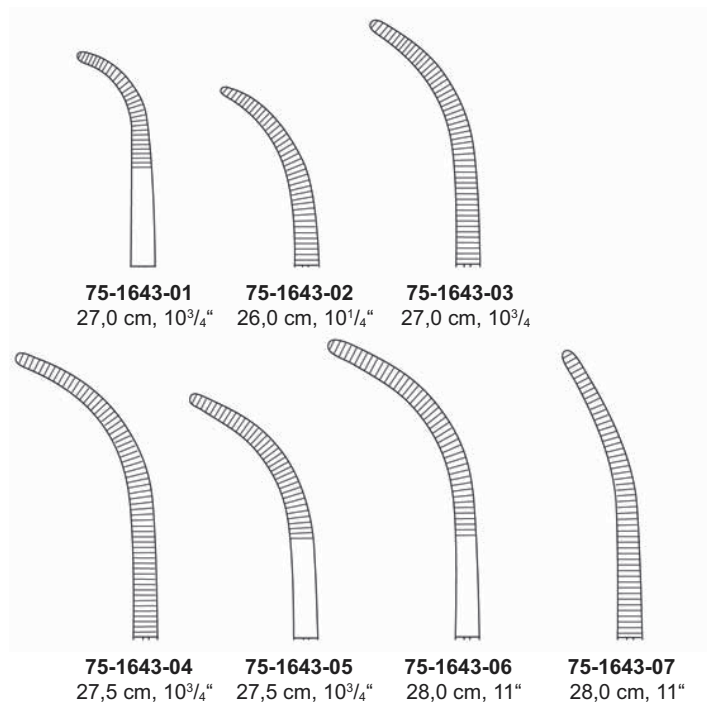

Präparier- und Ligaturklemmen  
Dissecting and Ligature Forceps  
Pinzas de disección y ligaduras  
Pinze per preparazioni e legature

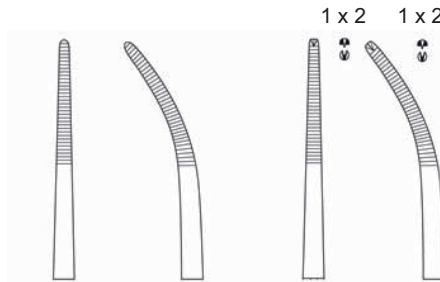

21,0 cm, 8 <sup>1</sup> / <sub>4</sub> "	<b>75-1644-21</b>	<b>75-1645-21</b>	<b>75-1646-21</b>	<b>75-1647-21</b>
26,0 cm, 10 <sup>1</sup> / <sub>4</sub> "	<b>AK-1644-26</b>	<b>75-1645-26</b>	<b>75-1646-26</b>	<b>75-1647-26</b>

**TOENNIS**

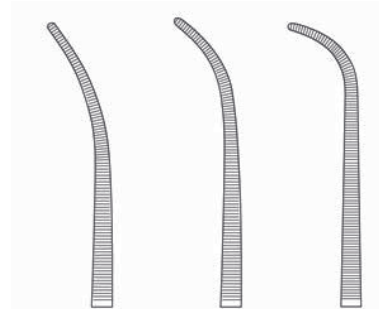

19,0 cm, 7 <sup>1</sup> / <sub>2</sub> "	<b>75-1648-19</b>	<b>75-1649-19</b>	<b>75-1650-19</b>
22,0 cm, 8 <sup>5</sup> / <sub>8</sub> "	<b>75-1648-22</b>	<b>75-1649-22</b>	<b>75-1650-22</b>
24,0 cm, 9 <sup>1</sup> / <sub>2</sub> "	<b>75-1648-24</b>	<b>75-1649-24</b>	<b>75-1650-24</b>

**KELLY**

**Präparier- und Ligaturklemmen**  
**Dissecting and Ligature Forceps**  
**Pinzas de disección y ligaduras**  
**Pinze per preparazioni e legature**



18,0 cm, 7"	<b>75-1651-18</b>
22,0 cm, 8 <sup>5</sup> / <sub>8</sub> "	<b>75-1651-22</b>
25,0 cm, 9 <sup>3</sup> / <sub>4</sub> "	<b>75-1651-25</b>
28,0 cm, 11"	<b>75-1651-28</b>

**MINI-GEMINI**

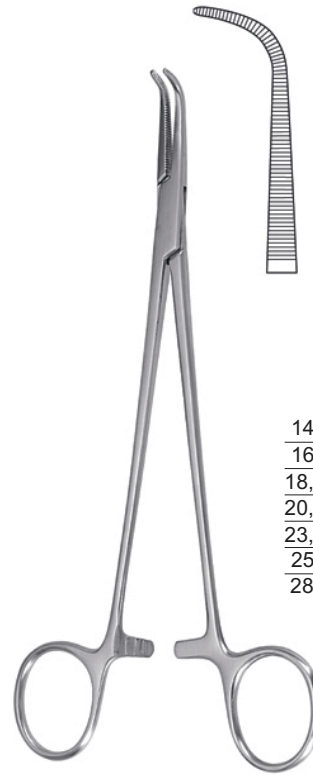

14,0 cm, 5 <sup>1</sup> / <sub>2</sub> "	<b>75-1652-14</b>
16,0 cm, 6 <sup>1</sup> / <sub>4</sub> "	<b>75-1652-16</b>
18,0 cm, 7"	<b>75-1652-18</b>
20,0 cm, 8"	<b>75-1652-20</b>
23,0 cm, 9"	<b>75-1652-23</b>
25,0 cm, 9 <sup>3</sup> / <sub>4</sub> "	<b>75-1652-25</b>
28,0 cm, 11"	<b>75-1652-28</b>

**GEMINI**

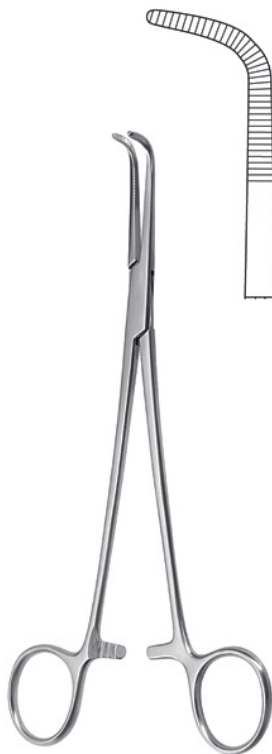

20,0 cm, 8"	<b>75-1653-20</b>
24,0 cm, 9 <sup>1</sup> / <sub>2</sub> "	<b>75-1653-24</b>
28,0 cm, 11"	<b>75-1653-28</b>

**KANTROWITZ**



19,0 cm, 7 <sup>1</sup> / <sub>2</sub> "	<b>75-1654-19</b>
21,0 cm, 8 <sup>1</sup> / <sub>4</sub> "	<b>75-1654-21</b>
24,0 cm, 9 <sup>1</sup> / <sub>2</sub> "	<b>75-1654-24</b>

**WIKSTROEM**

Präparier- und Ligaturklemmen  
Dissecting and Ligature Forceps  
Pinzas de disección y ligaduras  
Pinze per preparazioni e legature



**MIXTER**  
15,5 cm, 6" **AK-1655-15**  
19,0 cm, 7½" **AK-1655-19**



**MIXTER-O'SHAUGNESSY**  
15,5 cm, 6" **75-1656-15**  
19,0 cm, 7½" **75-1656-19**

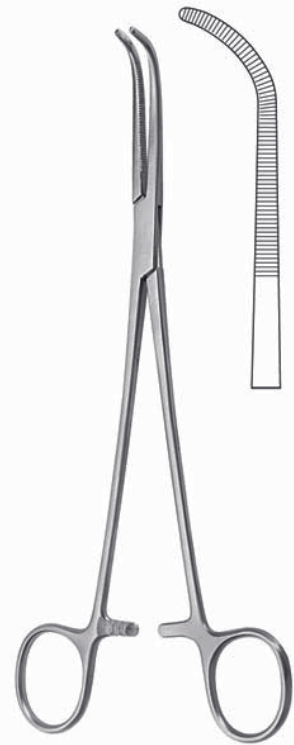

**MIXTER**  
22,0 cm, 8¾" **75-1657-22**



**MIXTER**  
23,0 cm, 9" **75-1473-23**

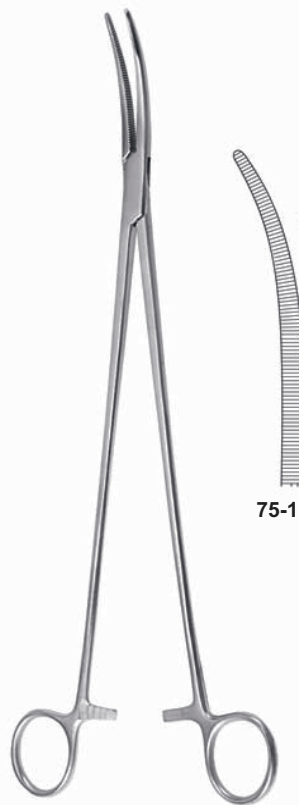

**ZENKER**

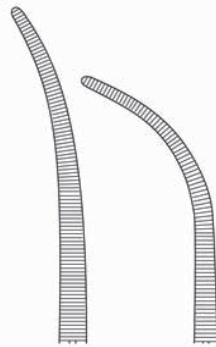

**75-1658-01 75-1659-02**



**ZENKER**

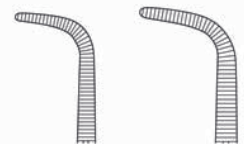

**AK-1660-18 75-1661-28**



Präparier- und Ligaturklemmen  
Dissecting and Ligature Forceps  
Pinzas de disección y ligaduras  
Pinze per preparazioni e legature



**LAWRENCE**  
27,5 cm, 10<sup>3</sup>/<sub>4</sub>"  
75-1664-28



**HOSEMANN**  
21,0 cm, 8<sup>1</sup>/<sub>4</sub>"

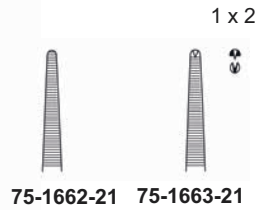

**DESJARDINS**  
21,0 cm, 8<sup>1</sup>/<sub>4</sub>"  
75-1665-21

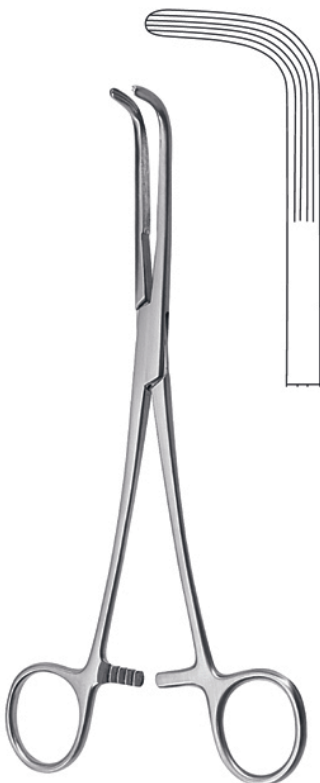

**MIXTER**  
22,0 cm, 8<sup>3</sup>/<sub>4</sub>" 75-1666-22  
25,0 cm, 9<sup>3</sup>/<sub>4</sub>" 75-1666-25  
28,0 cm, 11" 75-1666-28

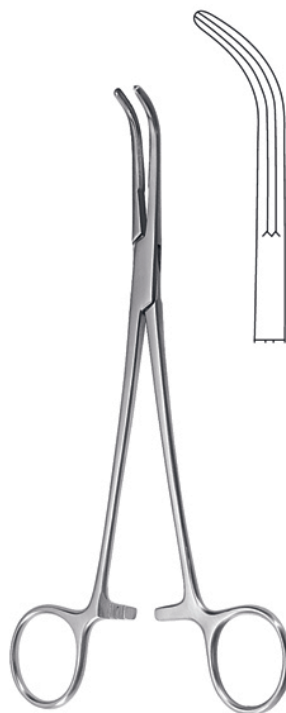

**LAHEY**  
19,0 cm, 7<sup>1</sup>/<sub>2</sub>" 75-1667-19  
23,0 cm, 9" 75-1667-23



18,0 cm, 7"  
75-1668-18

Präparier- und Ligaturklemmen  
Dissecting and Ligature Forceps  
Pinzas de disección y ligaduras  
Pinze per preparazioni e legature



**MC QUIGG-MIXTER**  
22,0 cm, 8<sup>3</sup>/<sub>4</sub>"  
AK-1671-22

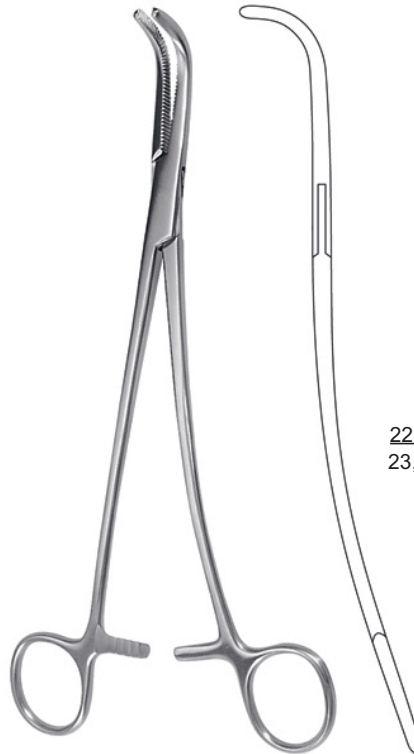

**GRAY**

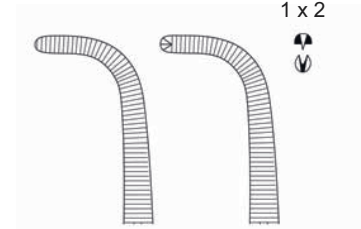

22,0 cm, 8<sup>3</sup>/<sub>4</sub>" 75-1669-22 75-1670-22  
23,0 cm, 9" 75-1669-23 75-1670-23



**CRAFOORD-SELLORS**

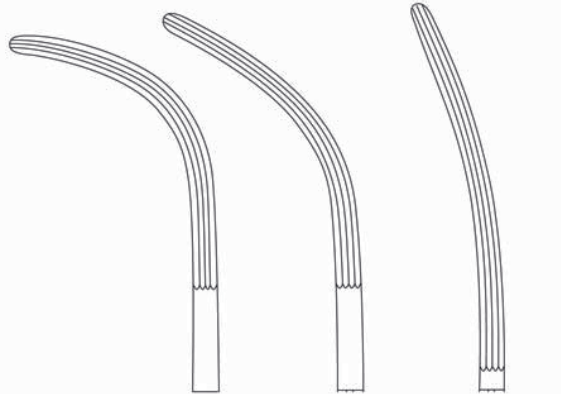

22,0 cm, 8<sup>3</sup>/<sub>4</sub>" 75-1672-22  
23,0 cm, 9" 75-1673-23  
24,0 cm, 9<sup>1</sup>/<sub>2</sub>" 75-1674-24



**FINOCCHIETTO**  
24,0 cm, 9<sup>1</sup>/<sub>2</sub>"  
75-1675-24

Gallenkanal- und Nierenstielklemmen  
 Gall Duct and Kidney Pedicle Clamps  
 Pinzas-clamps para pedúnculo renal  
 Pinze per peduncoli renali



**GUYON**  
 20,0 cm, 8" **75-1676-20**  
 22,0 cm, 8<sup>3</sup>/<sub>4</sub>" **75-1676-22**  
 24,0 cm, 9<sup>1</sup>/<sub>2</sub>" **75-1676-24**

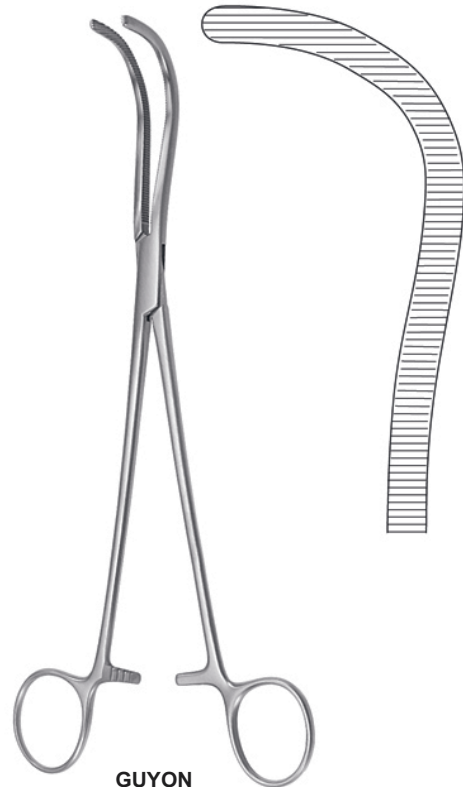

**GUYON**  
 23,0 cm, 9"  
**75-1677-23**



23,0 cm, 9"  
**75-1678-23**

24,0 cm, 9<sup>1</sup>/<sub>2</sub>"  
**75-1679-24**

**GUYON**

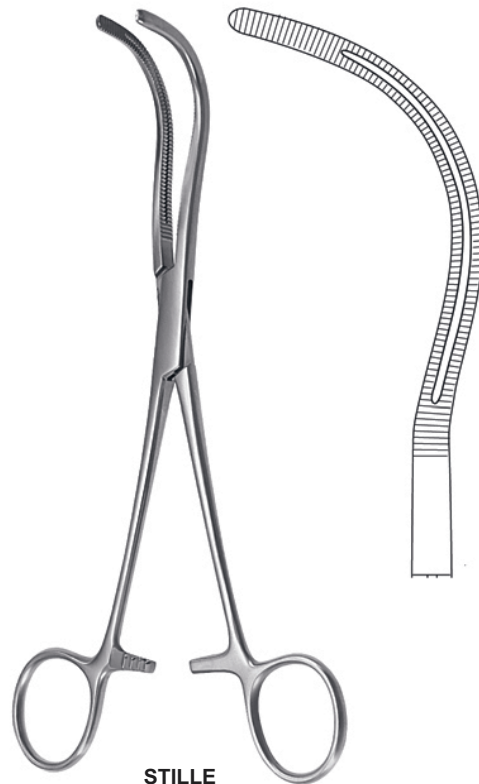

**STILLE**  
 23,0 cm, 9"  
**75-1680-23**

Bronchusklemmen, Peritoneumklemmen, Hysterektomieklemmen  
 Bronchus Forceps, Peritoneum Forceps, Hysterectomy Forceps  
 Pinzas-clamps para bronquios, Pinzas-clamps para peritoneo y para histerectomía  
 Pinze per legature, Pinze per peritoneo e per isterectomia



**PRICE-THOMAS**  
 22,0 cm, 8<sup>3</sup>/<sub>4</sub>"

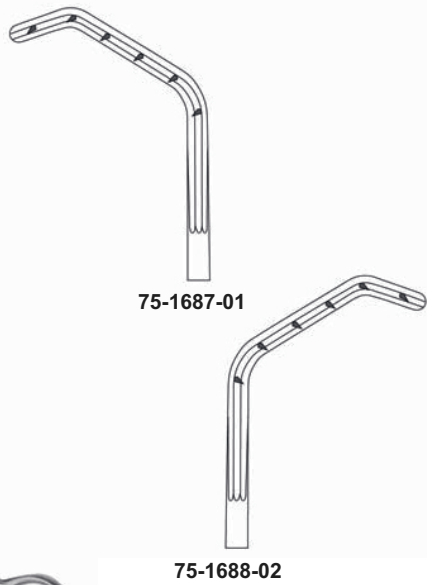

75-1687-01

75-1688-02



75-1689-01

75-1690-02

24,0 cm, 9<sup>1</sup>/<sub>2</sub>"

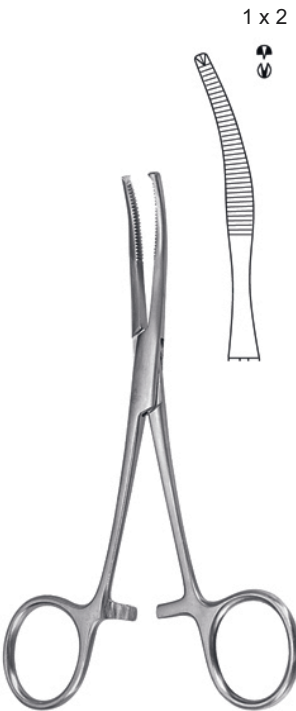

**BABY-MIKULICZ**  
 14,0 cm, 5<sup>1</sup>/<sub>2</sub>"  
 75-1691-14

1 x 2  



**MIKULICZ**  
 18,0 cm, 7"  
 75-1692-18

1 x 2  





**MIKULICZ**  
 20,0 cm, 8"  
 75-1693-20

1 x 2  

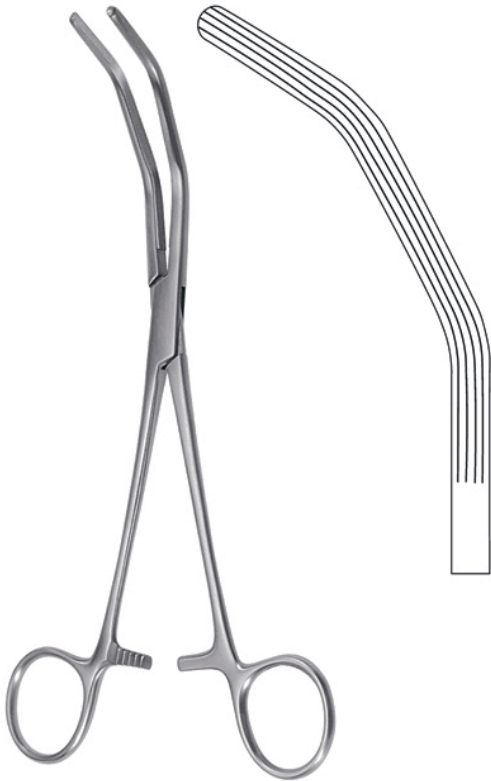

Gallenkanal- und Nierenstielklemmen, Bronchusklemmen  
 Gall Duct and Kidney Pedicle Clamps, Bronchus Forceps  
 Pinzas-clamps para pedúnculo renal, Pinzas-clamps para bronquios  
 Pinze per peduncoli renali, Pinze per legature

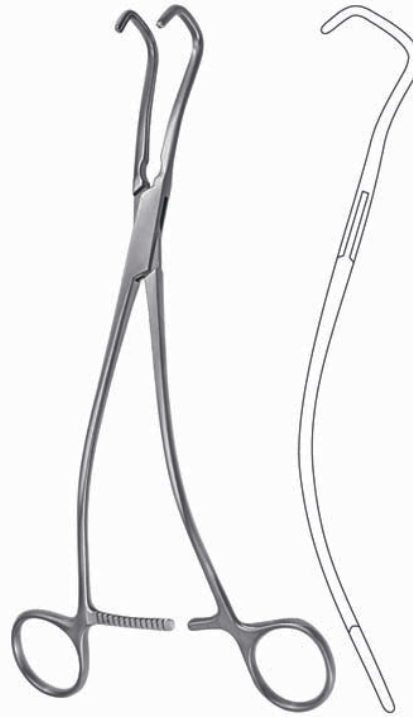

**HERRICK**  
23,0 cm, 9"  
75-1681-23

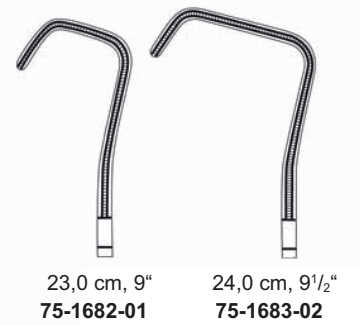

**URO-TANGENTIAL**  
26,0 cm, 10<sup>1</sup>/<sub>4</sub>"



**LOVELACE**  
20,0 cm, 8"  
75-1684-20



**LOVELACE**  
20,0 cm, 8"  
75-1685-20

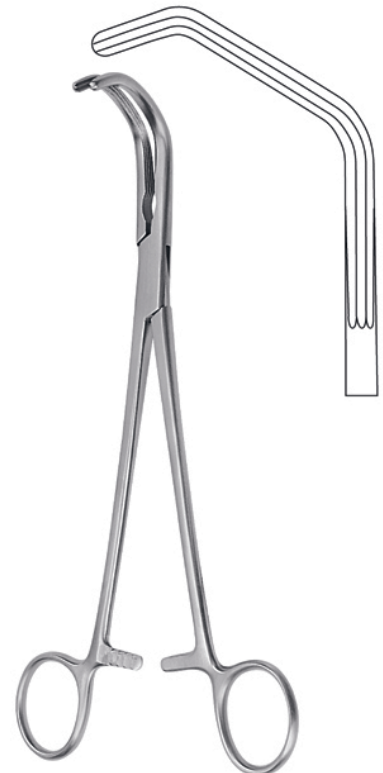

**PRICE-THOMAS**  
22,0 cm, 8<sup>3</sup>/<sub>4</sub>"  
75-1686-22

**Hysterektomieklemmen**  
**Hysterectomy Forceps**  
**Pinzas-clamps para histerectomía**  
**Pinze per isterectomia**



**WERTHEIM**  
23,0 cm, 9"

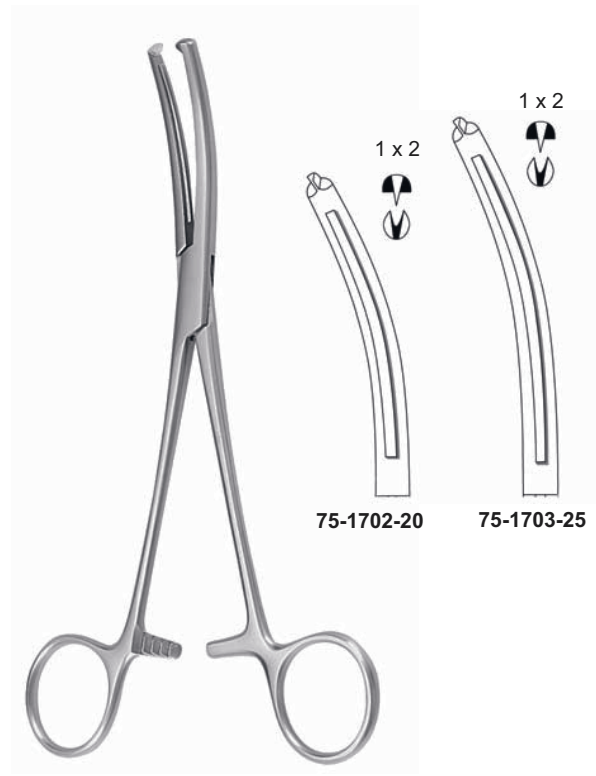
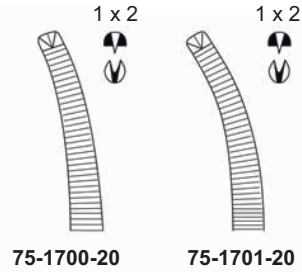

**MAINGOT**  
21,5 cm, 8½"

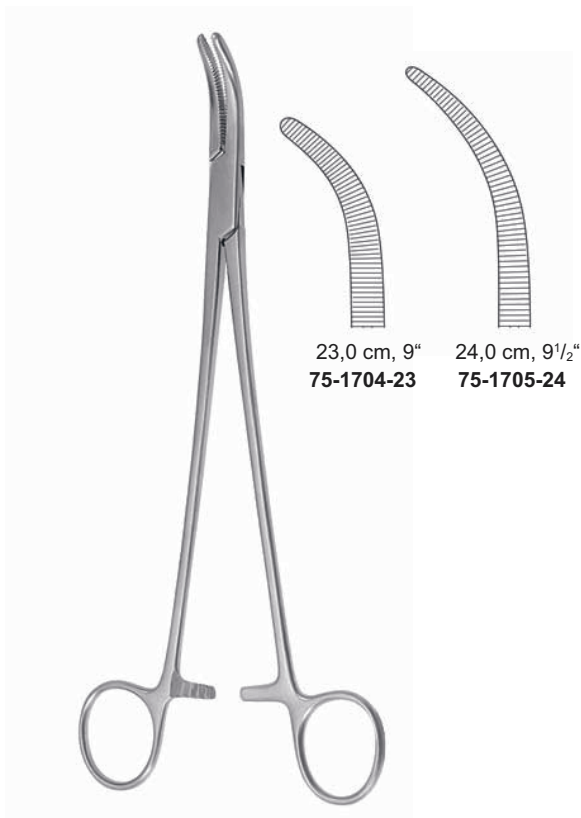
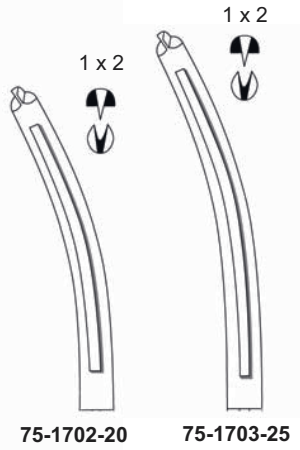

**MOYNIHAN**

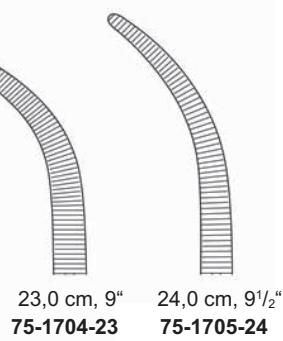

**WERTHEIM-CULLEN**  
21,5 cm, 8½"  
75-1706-21

Peritoneumklemmen, Hysterektomieklemmen  
Peritoneum Forceps, Hysterectomy Forceps  
Pinzas-clamps para peritoneo y para histerectomía  
Pinze per peritoneo e per isterectomia

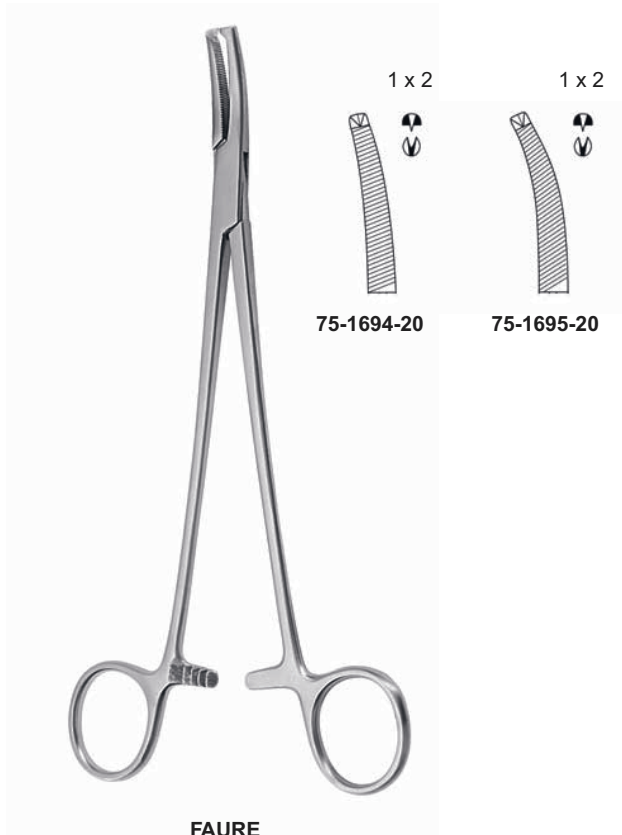

**FAURE**  
20,0 cm, 8"

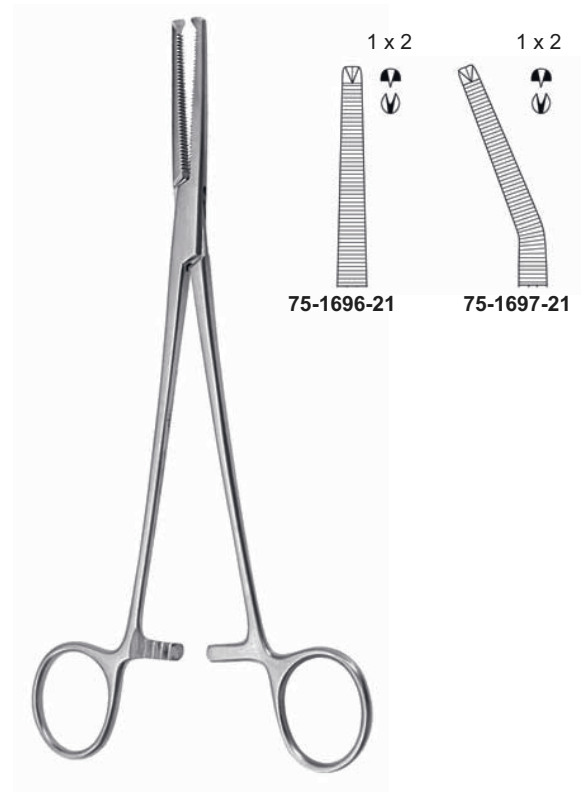

**PHANEUF**  
21,5 cm, 8 1/2"

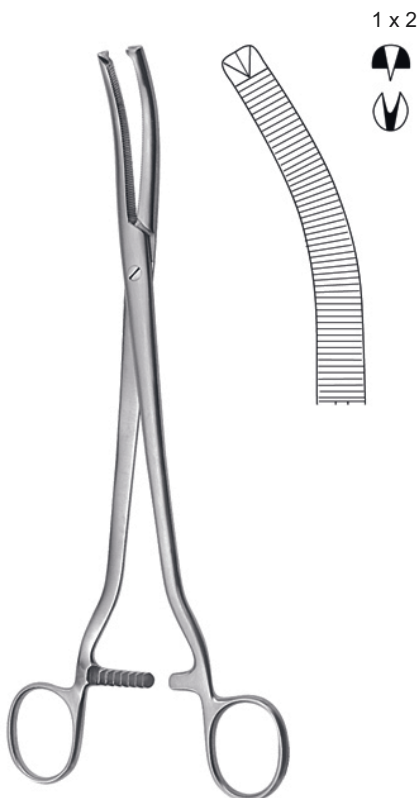

**WERTHEIM**  
24,0 cm, 9 1/2"  
75-1698-24



**WERTHEIM**  
25,0 cm, 10"  
75-1699-25

Hysterektomieklemmen  
Hysterectomy Forceps  
Pinzas-clamps para histerectomia  
Pinze per isterectomia

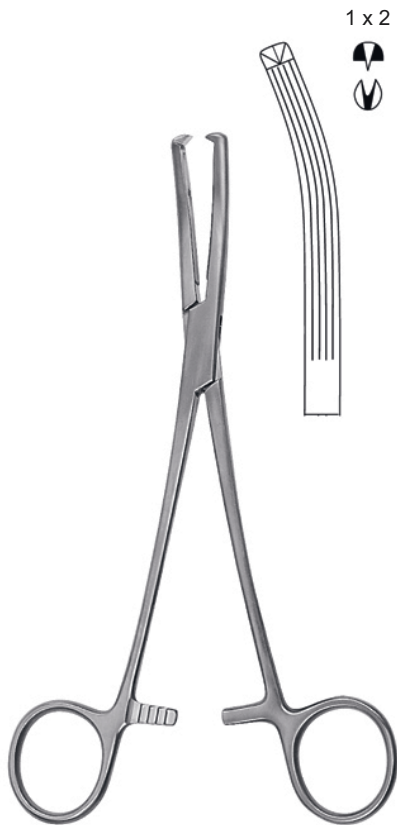

**LONG**  
19,0 cm, 7<sup>1</sup>/<sub>4</sub>"  
75-1707-19

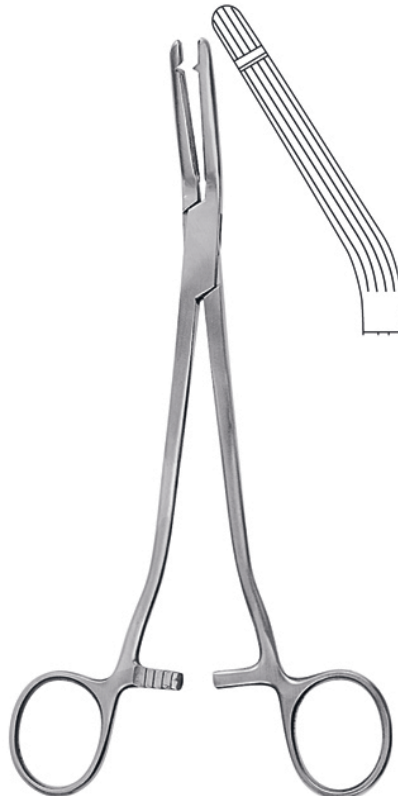

**GARLAND**  
21,0 cm, 8<sup>1</sup>/<sub>4</sub>"  
75-1708-21



**HEANEY**  
21,0 cm, 8<sup>1</sup>/<sub>4</sub>"  
75-1709-21

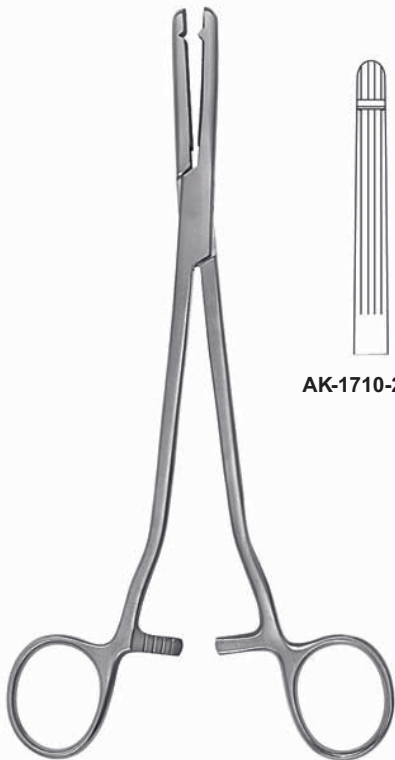

**HEANEY-BALLANTINE**  
21,0 cm, 8<sup>1</sup>/<sub>4</sub>"

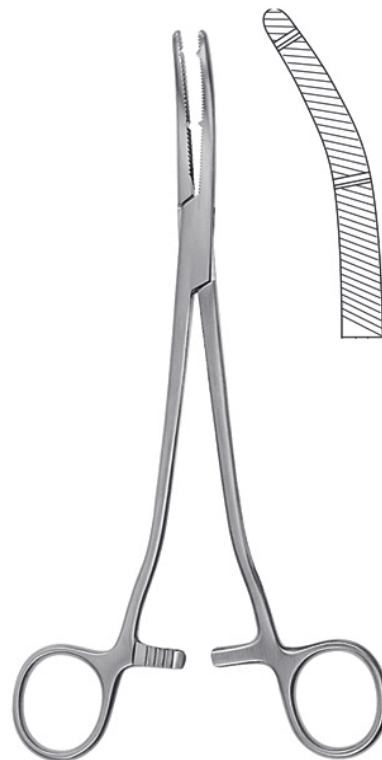
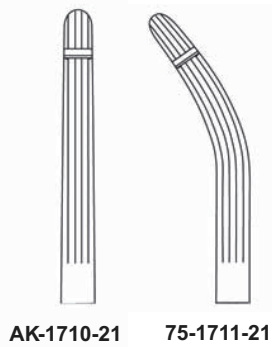

**HEANEY-KANTER**  
21,0 cm, 8<sup>1</sup>/<sub>4</sub>"  
75-1712-21



# Surgical Catalogue

Hysterektomieklemmen  
Hysterectomy Forceps  
Pinzas-clamps para histerectomia  
Pinze per isterectomia

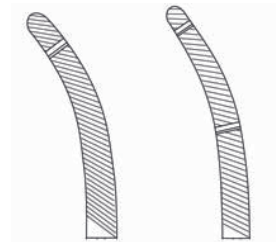

21,0 cm, 8 <sup>1</sup> / <sub>4</sub> "	<b>75-1713-21</b>	<b>75-1714-21</b>
23,0 cm, 9"	<b>75-1713-23</b>	<b>75-1714-23</b>



**Nahtinstrumente**  
**Suture Instruments**  
**Instrumentos para sutura**  
**Strumenti per sutura**

**Nadelhalter  
Needle Holders  
Porta-agujas  
Portaghi**



**75-1715-12**  
12,0 cm, 4<sup>3</sup>/<sub>4</sub>"



**75-1716-12**  
12,5 cm, 5"



**COLLIER**  
12,5 cm, 5"  
**75-1717-12**



**WEBSTER**  
13,0 cm, 5"  
**75-1718-13**



**HALSEY**  
13,0 cm, 5"

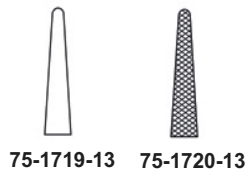

**75-1719-13**   **75-1720-13**



**NEIVERT**  
13,0 cm, 5"  
**75-1721-13**



**HEGAR-BAUMGARTNER**  
14,0 cm, 5<sup>1</sup>/<sub>2</sub>"  
**75-1722-14**

**Nadelhalter  
Needle Holders  
Porta-agujas  
Portaghi**



**75-1723-13**  
13,0 cm, 5"

**BROWN**



**CRILE-MURRAY**  
15,0 cm, 6"  
**75-1725-15**



**75-1724-15**  
15,0 cm, 6"

**CRILE-WOOD**



**ADSON**  
18,0 cm, 7"  
**75-1726-18**



**METZENBAUM**  
18,0 cm, 7"  
**75-1727-18**



**MASS.-GENERAL-HOSPITAL**  
17,0 cm, 6<sup>3</sup>/<sub>4</sub>"  
**75-1728-17**

Nadelhalter  
Needle Holders  
Porta-agujas  
Portaghi



**MAYO-HEGAR**



75-1729-14



75-1729-16



75-1729-18



75-1729-20



75-1729-24



75-1729-26



75-1729-30



**MAYO-HEGAR-DELICATE**



75-1730-16  
16,0 cm, 6<sup>1</sup>/<sub>4</sub>"



75-1730-18  
18,0 cm, 7"



75-1730-20  
20,0 cm, 8"



**LAWRENCE**  
15,0 cm, 6"  
75-1731-15

Nadelhalter  
Needle Holders  
Porta-agujas  
Portaghi



**HEANEY**

21,0 cm, 8<sup>1</sup>/<sub>4</sub>"  
75-1732-21



**JAMISON**

23,5 cm, 9<sup>1</sup>/<sub>4</sub>"  
75-1733-23



**MASSON**

27,0 cm, 10<sup>1</sup>/<sub>2</sub>"  
75-1734-27



**FINOCCHIETTO**  
27,0 cm, 10<sup>1</sup>/<sub>2</sub>"  
75-1735-27



**WANGENSTEEN**  
27,0 cm, 10<sup>1</sup>/<sub>2</sub>"  
75-1736-27



**JOHNSON**  
27,0 cm, 10<sup>1</sup>/<sub>2</sub>"  
75-1737-27

**Nadelhalter  
Needle Holders  
Porta-agujas  
Portaghi**

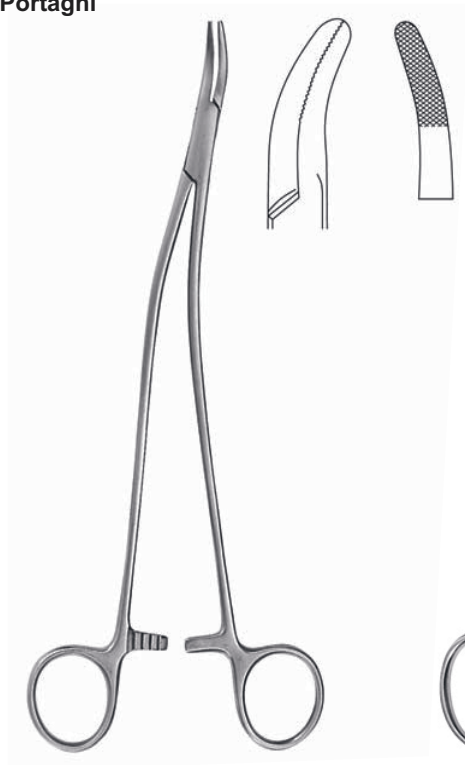

**STRATTE**  
23,0 cm, 9"  
75-1738-23



**OLSEN-HEGAR**  
17,0 cm, 6<sup>3</sup>/<sub>4</sub>"  
75-1739-17

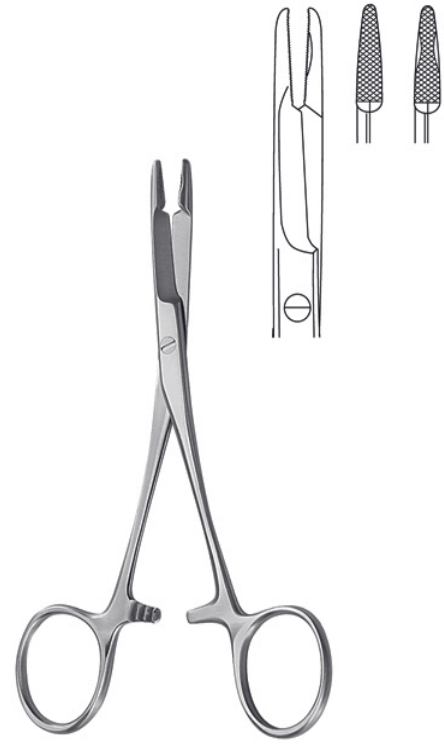

**OLSEN-HEGAR**  
14,0 cm, 5<sup>1</sup>/<sub>2</sub>"  
75-1740-14



**OLSEN-HEGAR**

14,0 cm, 5<sup>1</sup>/<sub>2</sub>"  
75-1741-14

18,0 cm, 7"  
75-1741-18



**TOENNIS**  
18,0 cm, 7"  
75-1742-18

**Nadelhalter, Mikro-Nadelhalter**  
**Needle Holders, Micro Needle Holders**  
**Porta-agujas, Micro Porta-agujas**  
**Portaghi, Micro Portaghi**



**MATHIEU-KOCHER**



**75-1747-14**  
14,0 cm, 5½"



**75-1747-17**  
17,0 cm, 6¾"



**75-1747-20**  
20,0 cm, 8"



**BARRAQUER-TROUTMAN**  
10,0 cm, 4"



**75-1748-10**



**75-1749-10**



**BARRAQUER**



**75-1750-10**



**75-1751-10**



**BARRAQUER**  
13,5 cm, 5⅜"  
**75-1752-13**



**GOMEL**  
14,0 cm, 5½"  
**75-1753-14**





**Nadelhalter  
Needle Holders  
Porta-agujas  
Portaghi**



**75-1743-14**  
14,0 cm, 5½"



**75-1743-17**  
17,0 cm, 6¾"



**75-1743-20**  
20,0 cm, 8"



**75-1744-17**  
17,0 cm, 6¾"



**75-1744-20**  
20,0 cm, 8"



**MATHIEU**

**MATHIEU**



**LICHTENBERG**  
20,0 cm, 8"  
**75-1746-20**



**75-1745-14**  
14,0 cm, 5½"



**75-1745-17**  
17,0 cm, 6¾"



**MATHIEU**

**Mikro-Nadelhalter**  
**Micro Needle Holders**  
**Micro Porta-agujas**  
**Micro Portaghi**



ohne Sperre  
without ratchet  
sin cremallera  
senza cremagliera

18,5 cm, 7<sup>1</sup>/<sub>4</sub>"

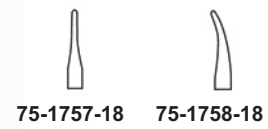

mit Sperre  
with ratchet  
con cremallera  
con cremagliera

18,5 cm, 7<sup>1</sup>/<sub>4</sub>"

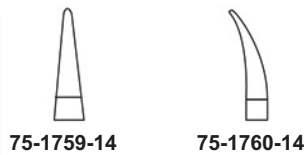

mit Sperre  
with ratchet  
con cremallera  
con cremagliera

**CASTROVIEJO**  
14,5 cm, 5<sup>3</sup>/<sub>4</sub>"

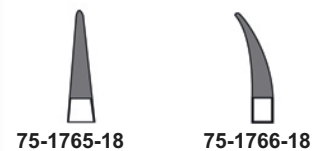
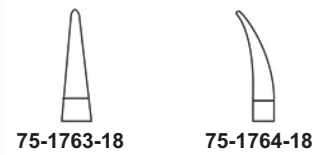

mit Sperre  
with ratchet  
con cremallera  
con cremagliera

**CASTROVIEJO**  
18,0 cm, 7"

**Mikro-Nadelhalter**  
**Micro Needle Holders**  
**Micro Porta-agujas**  
**Micro Portaghi**

0,4 mm



gerade, ohne Sperre  
straight, without ratchet  
recta, sin cremallera  
retta, senza cremagliera

14,0 cm, 5 1/2"  
75-1767-14

0,4 mm



gebogen, ohne Sperre  
curved, without ratchet  
curva, sin cremallera  
curva, senza cremagliera

14,0 cm, 5 1/2"  
75-1768-14

0,4 mm



14,0 cm, 5 1/2"  
75-1769-14

0,5 mm



gebogen, ohne Sperre  
curved, without ratchet  
curva, sin cremallera  
curva, senza cremagliera

Ø 10 mm

14,0 cm, 5 1/2"  
75-1770-14

0,5 mm



gebogen, ohne Sperre  
curved, without ratchet  
curva, sin cremallera  
curva, senza cremagliera

Ø 10 mm

14,0 cm, 5 1/2"  
75-1771-14

0,4 mm



gebogen, ohne Sperre  
curved, without ratchet  
curva, sin cremallera  
curva, senza cremagliera

Ø 8 mm

13,0 cm, 5"  
75-1772-13

0,4 mm



gebogen, ohne Sperre  
curved, without ratchet  
curva, sin cremallera  
curva, senza cremagliera

Ø 8 mm

13,0 cm, 5"  
75-1773-13

Nadelhalter mit Hartmetalleinlagen  
Needle Holders with tungsten carbide inserts  
Porta-agujas con bocas de carburo tungsteno  
Portaghi con morsi in carburo di tungsteno



**KALT**  
13,5 cm, 5<sup>3</sup>/<sub>8</sub>"  
75-1776-14



16,0 cm, 5 <sup>3</sup> / <sub>8</sub> "	<b>75-1775-16</b>
18,0 cm, 7"	<b>75-1775-18</b>
20,0 cm, 8"	<b>75-1775-20</b>
23,0 cm, 9"	<b>75-1775-23</b>
26,0 cm, 10 <sup>1</sup> / <sub>4</sub> "	<b>75-1775-26</b>

**DIETHRICH**



**WEBSTER**  
13,0 cm, 5"  
75-1777-13



**DERF**  
12,0 cm, 4<sup>3</sup>/<sub>4</sub>"  
75-1780-12



**75-1778-12**  
12,5 cm, 5"



**75-1779-14**  
14,0 cm, 5<sup>1</sup>/<sub>2</sub>"

**HEGAR-BAUMGARTNER**



**WEBSTER**  
13,0 cm, 5"  
75-1781-13

Nadelhalter mit Hartmetalleinlagen  
 Needle Holders with tungsten carbide inserts  
 Porta-agujas con bocas de carburo tungsteno  
 Portaghi con morsi in carburo di tungsteno



**HALSEY**  
13,0 cm, 5"

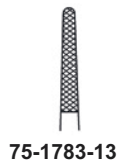

**CRILE-WOOD**

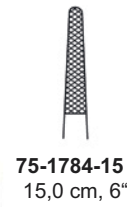

**SAROT**

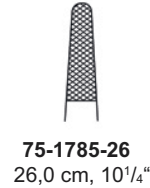

Nadelhalter mit Hartmetalleinlagen  
Needle Holders with tungsten carbide inserts  
Porta-agujas con bocas de carburo tungsteno  
Portaghi con morsi in carburo di tungsteno



**75-1786-16**  
16,0 cm, 6<sup>1</sup>/<sub>4</sub>"

**75-1786-18**  
18,0 cm, 7"

**75-1786-20**  
20,0 cm, 8"

**75-1786-24**  
24,0 cm, 9<sup>1</sup>/<sub>2</sub>"

**75-1786-26**  
26,0 cm, 10<sup>1</sup>/<sub>4</sub>"

**75-1786-30**  
30,0 cm, 12"

**MAYO-HEGAR**



**75-1787-20**  
20,0 cm, 8"

**75-1787-24**  
24,0 cm, 9<sup>1</sup>/<sub>4</sub>"

**75-1787-26**  
26,0 cm, 10<sup>1</sup>/<sub>4</sub>"

**MAYO-HEGAR (HEANEY)**

# Surgical Catalogue

Nadelhalter mit Hartmetalleinlagen  
 Needle Holders with tungsten carbide inserts  
 Porta-agujas con bocas de carburo tungsteno  
 Portaghi con morsi in carburo di tungsteno

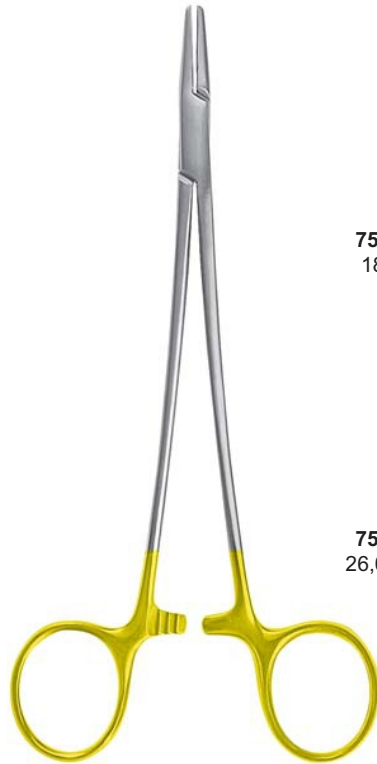

**DE BAKEY**



**75-1788-18**  
18,0 cm, 7"



**75-1788-20**  
20,0 cm, 8"



**75-1788-23**  
23,0 cm, 9"



**75-1788-26**  
26,0 cm, 10<sup>1</sup>/<sub>4</sub>"



**75-1788-31**  
31,0 cm, 12<sup>1</sup>/<sub>4</sub>"



**75-1788-37**  
37,0 cm, 14<sup>1</sup>/<sub>2</sub>"

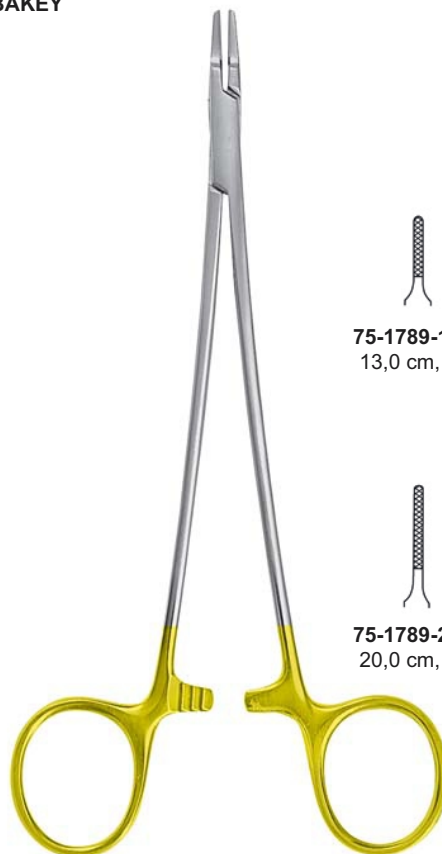

**RYDER-VASCULAR**



**75-1789-13**  
13,0 cm, 5"



**75-1789-15**  
15,0 cm, 6"

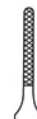

**75-1789-18**  
18,0 cm, 7"

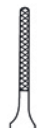

**75-1789-20**  
20,0 cm, 8"

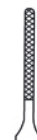

**75-1789-23**  
23,0 cm, 9"



**75-1789-26**  
26,0 cm, 10<sup>1</sup>/<sub>4</sub>"

**Nadelhalter mit Hartmetalleinlagen**  
**Needle Holders with tungsten carbide inserts**  
**Porta-agujas con bocas de carburo tungsteno**  
**Portaghi con morsi in carburo di tungsteno**



**RYDER**

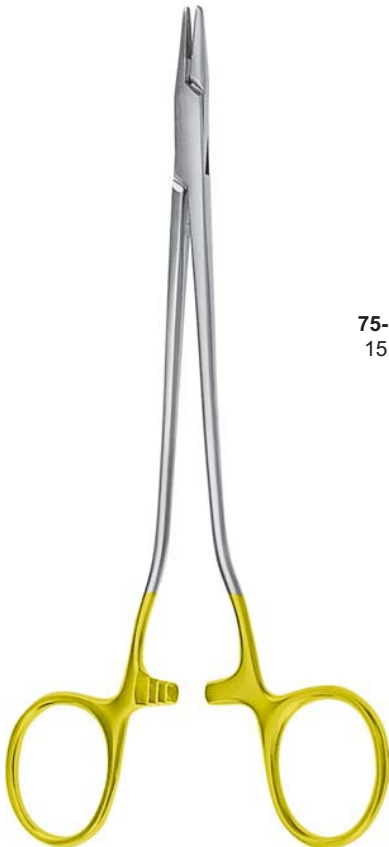
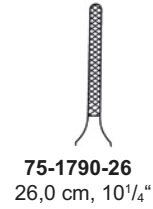
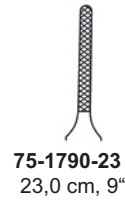
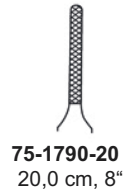
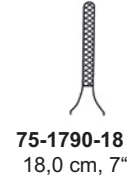
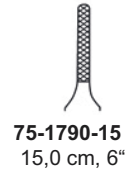
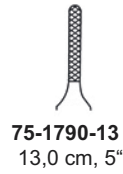

**SCHWEDISCHES MODELL**

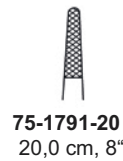
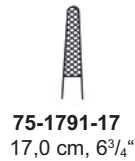
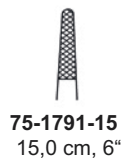



Nadelhalter mit Hartmetalleinlagen  
Needle Holders with tungsten carbide inserts  
Porta-agujas con bocas de carburo tungsteno  
Portaghi con morsi in carburo di tungsteno

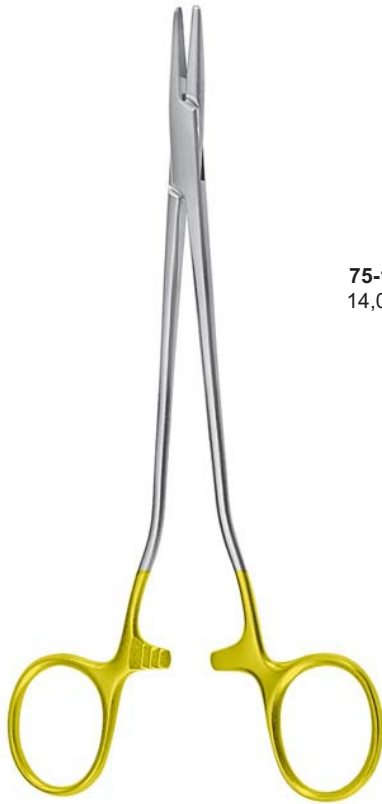

**MAYO-HEGAR (HEANEY)**



**75-1792-14**  
14,0 cm, 5½"



**75-1792-18**  
18,0 cm, 7"



**75-1792-20**  
20,0 cm, 8"



**75-1792-23**  
23,0 cm, 9"



**FINOCCHIETTO**  
27,0 cm, 10½"  
75-1793-27



**MASSON**  
27,0 cm, 10½"  
75-1794-27



**WANGENSTEIN**  
27,0 cm, 10½"  
75-1795-27

Nadelhalter mit Hartmetalleinlagen  
Needle Holders with tungsten carbide inserts  
Porta-agujas con bocas de carburo tungsteno  
Portaghi con morsi in carburo di tungsteno



**BOZEMANN**

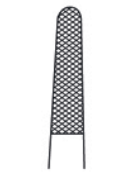

**75-1796-20**  
20,0 cm, 8"



**75-1796-24**  
24,0 cm, 9<sup>5</sup>/<sub>8</sub>"



**75-1796-26**  
26,0 cm, 10<sup>1</sup>/<sub>4</sub>"



**HEGAR**



**75-1797-20**  
20,0 cm, 8"



**75-1797-24**  
24,0 cm, 9<sup>5</sup>/<sub>8</sub>"



**BARRY STERNAL**



**75-1798-15**  
15,0 cm, 6"



**75-1798-20**  
20,0 cm, 8"

**Nadelhalter mit Hartmetalleinlagen**  
**Needle Holders with tungsten carbide inserts**  
**Porta-agujas con bocas de carburo tungsteno**  
**Portaghi con morsi in carburo di tungsteno**



**STRATTE**

**75-1799-22**  
22,0 cm, 8<sup>5</sup>/<sub>8</sub>"

**75-1799-23**  
23,0 cm, 9"



**GILLIES**  
16,0 cm, 6<sup>1</sup>/<sub>4</sub>"  
**75-1800-16**



**OLSEN-HEGAR**

**75-1801-14**  
14,0 cm, 5<sup>1</sup>/<sub>2</sub>"

**75-1801-17**  
17,0 cm, 6<sup>3</sup>/<sub>4</sub>"

**75-1801-18**  
18,0 cm, 7"



**TOENNIS**  
18,0 cm, 7"  
**75-1802-18**

Nadelhalter mit Hartmetalleinlagen  
Needle Holders with tungsten carbide inserts  
Porta-agujas con bocas de carburo tungsteno  
Portaghi con morsi in carburo di tungsteno



**MATHIEU-KOCHER**



**75-1803-14**  
14,0 cm, 5½"



**75-1803-17**  
17,0 cm, 6¾"



**75-1803-20**  
20,0 cm, 8"



**MATHIEU**



**75-1804-14**  
14,0 cm, 5½"



**75-1804-17**  
17,0 cm, 6¾"



**75-1804-20**  
20,0 cm, 8"

Nadelhalter mit Hartmetalleinlagen  
Needle Holders with tungsten carbide inserts  
Porta-agujas con bocas de carburo tungsteno  
Portaghi con morsi in carburo di tungsteno



LICHTENBERG



**75-1805-17**  
17,0 cm, 6<sup>3</sup>/<sub>4</sub>"



**75-1805-20**  
20,0 cm, 8"



MATHIEU



**75-1806-17**  
17,0 cm, 6<sup>3</sup>/<sub>4</sub>"



**75-1806-20**  
20,0 cm, 8"



**75-1806-23**  
23,0 cm, 9"

Nadelhalter mit Hartmetalleinlagen  
Needle Holders with tungsten carbide inserts  
Porta-agujas con bocas de carburo tungsteno  
Portaghi con morsi in carburo di tungsteno



**ZWEIFEL**



**75-1807-20**  
20,0 cm, 8"



**75-1807-23**  
23,0 cm, 9"



**LANGENBECK**



**75-1808-18**  
18,0 cm, 7"



**75-1808-20**  
20,0 cm, 8"



**75-1808-23**  
23,0 cm, 9"



**75-1809-18**  
18,0 cm, 7"



**75-1809-20**  
20,0 cm, 8"



**75-1809-23**  
23,0 cm, 9"

Nadelhalter mit Hartmetalleinlagen  
 Needle Holders with tungsten carbide inserts  
 Porta-agujas con bocas de carburo tungsteno  
 Portaghi con morsi in carburo di tungsteno



75-1810-14



75-1810-14



75-1810-14



75-1810-14

mit Sperre  
 with ratchet  
 con cremallera  
 con cremagliera

**CASTROVIEJO**  
 14,5 cm, 5<sup>3</sup>/<sub>4</sub>"



75-1811-18



75-1812-18



75-1813-18



75-1874-18

mit Sperre  
 with ratchet  
 con cremallera  
 con cremagliera

**CASTROVIEJO**  
 18,0 cm, 7"



75-1815-14



75-1816-14



75-1817-14



75-1818-14

mit Sperre  
 with ratchet  
 con cremallera  
 con cremagliera

**BARRAQUER**  
 14,5 cm, 5<sup>3</sup>/<sub>4</sub>"



**HEPP SCHEIDEL**  
 18,0 cm, 7"  
 75-1819-18

REVERDIN-Nadeln  
REVERDIN Needles  
Agujas de REVERDIN  
Aghi di REVERDIN



**REVERDIN**  
14,0 cm, 5 1/2"



75-1820-01

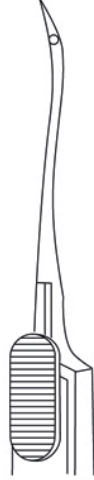

75-1820-02



75-1820-03



75-1820-04



**REVERDIN**

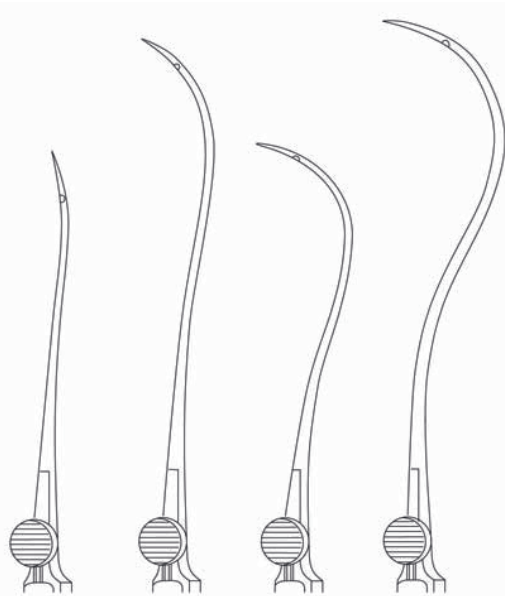

19,5 cm, 7 3/4" 75-1821-01 75-1821-02 75-1821-03 75-1821-04  
22,5 cm, 8 3/4" 75-1822-01 75-1822-02 75-1822-03 75-1822-04



**Unterbindungsnadeln  
Ligature Needles  
Agujas para ligaduras  
Aghi per legatura**

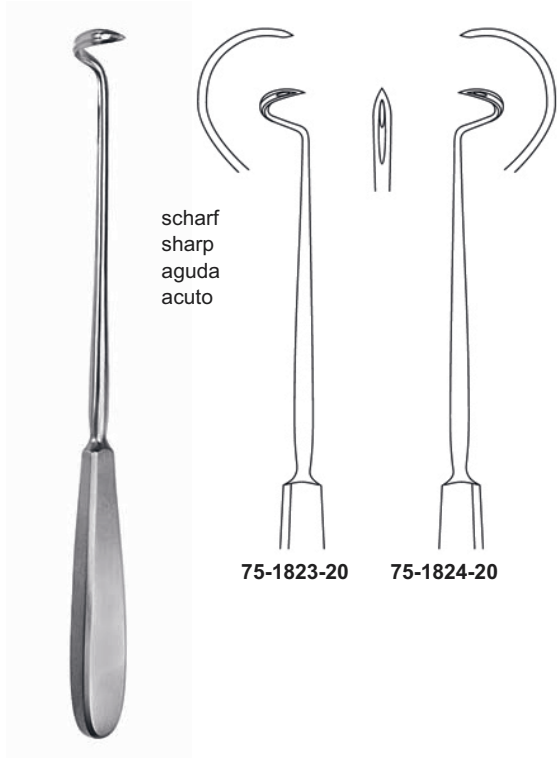

scharf  
sharp  
aguda  
acuto

75-1823-20

75-1824-20

**DESCHAMPS**  
20,0 cm, 8"

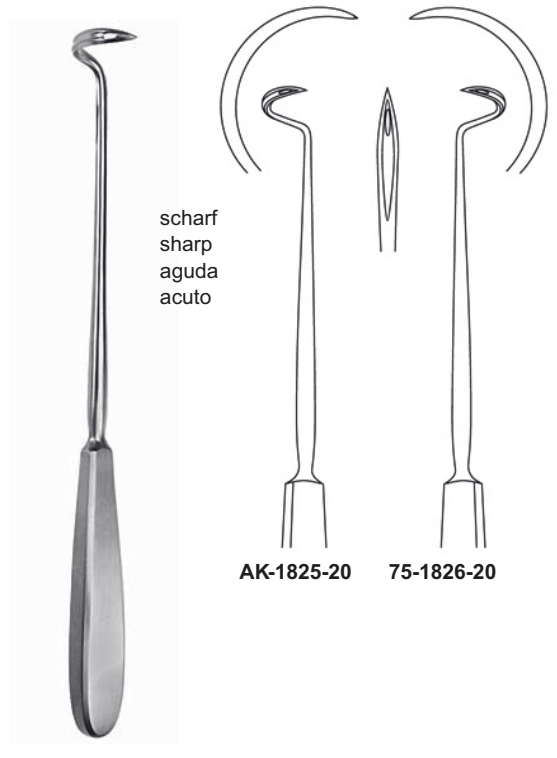

scharf  
sharp  
aguda  
acuto

AK-1825-20

75-1826-20

**DESCHAMPS**  
20,0 cm, 8"

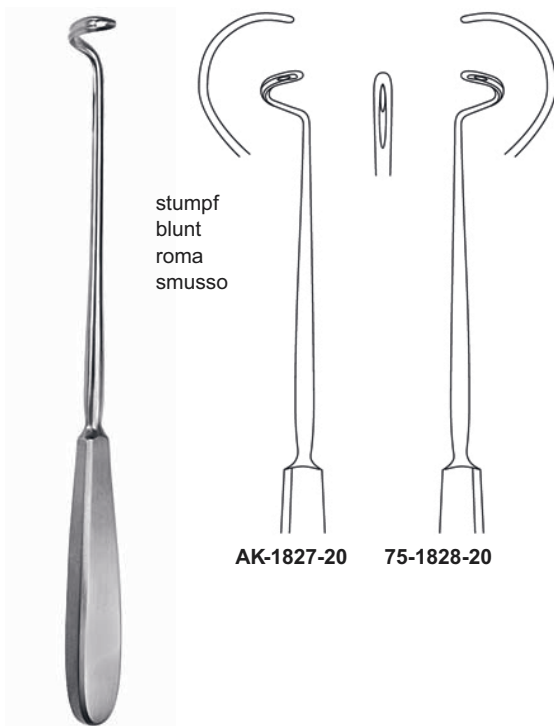

stumpf  
blunt  
roma  
smusso

AK-1827-20

75-1828-20

**DESCHAMPS**  
20,0 cm, 8"

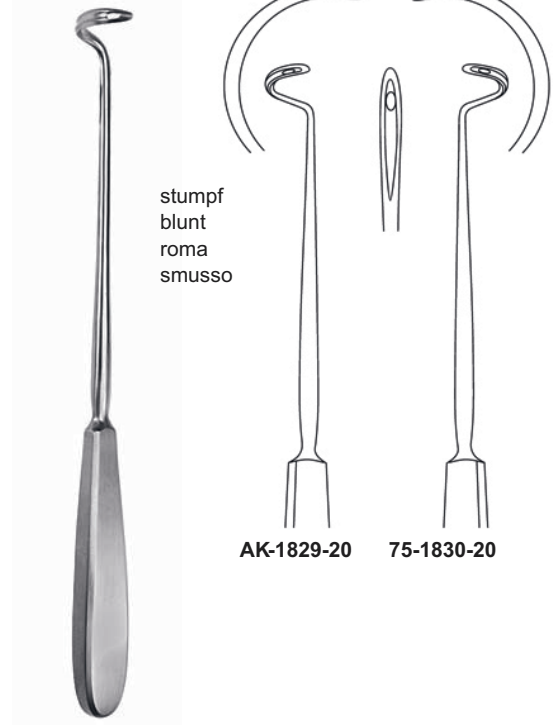

stumpf  
blunt  
roma  
smusso

AK-1829-20

75-1830-20

**DESCHAMPS**  
20,0 cm, 8"

Unterbindungsnadeln  
Ligature Needles  
Agujas para ligaduras  
Aghi per legatura

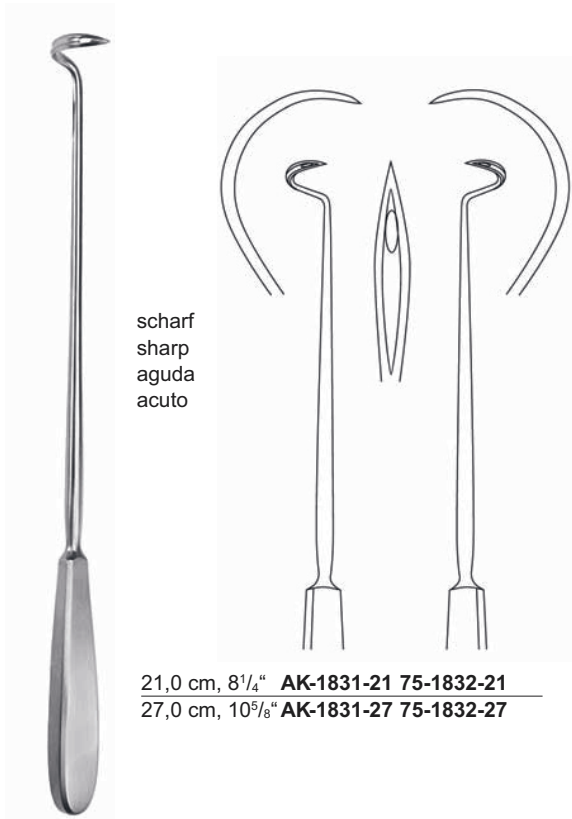

scharf  
sharp  
aguda  
acuto

21,0 cm, 8<sup>1</sup>/<sub>4</sub>" **AK-1831-21 75-1832-21**  
27,0 cm, 10<sup>5</sup>/<sub>8</sub>" **AK-1831-27 75-1832-27**

**DESCHAMPS**

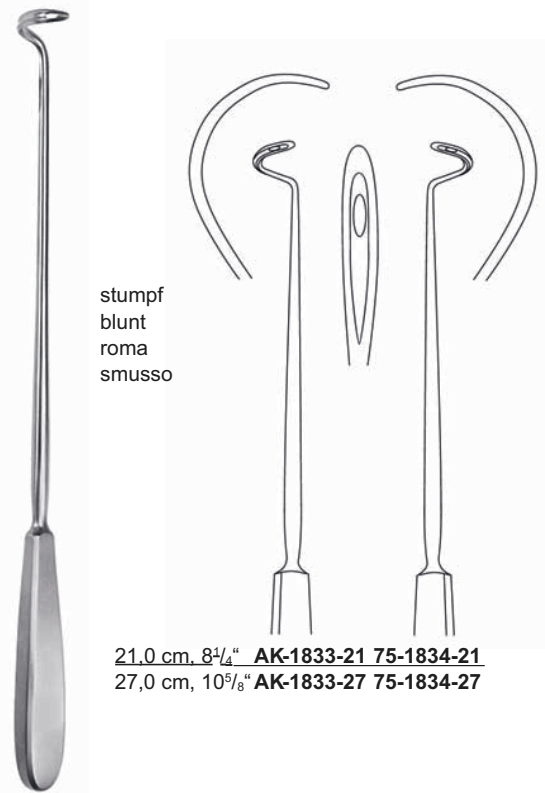

stumpf  
blunt  
roma  
smusso

21,0 cm, 8<sup>1</sup>/<sub>4</sub>" **AK-1833-21 75-1834-21**  
27,0 cm, 10<sup>5</sup>/<sub>8</sub>" **AK-1833-27 75-1834-27**

**DESCHAMPS**



biegsam  
malleable  
maleable  
malleabile

20,0 cm, 8"  
**75-1835-20**



**COOPER**  
19,0 cm, 7<sup>1</sup>/<sub>2</sub>"  
**75-1836-19**



**COOPER**  
20,0 cm, 8"  
**75-1837-20**



**SYME**  
15,0 cm, 6"  
**75-1838-15**

Unterbindungsnadeln  
Ligature Needles  
Agujas para ligaduras  
Aghi per legatura



**KOCHER**  
19,0 cm, 7 $\frac{1}{2}$ "



75-1839-01



75-1839-02



75-1839-03



**BRUNNER**  
25,0 cm, 9 $\frac{3}{4}$ "  
75-1840-25



**BRUNNER**  
30,0 cm, 11 $\frac{3}{4}$ "



75-1841-01



75-1841-02



**SCHMIEDEN**  
21,0 cm, 8 $\frac{1}{4}$ "  
75-1842-21

Unterbindungsnadeln  
Ligature Needles  
Agujas para ligaduras  
Aghi per legatura



**KRONECKER**  
15,0 cm, 6"  
75-1850-02



**TRÉLAT**  
23,0 cm, 9"  
75-1851-23



**CLAUS**  
23,0 cm, 9"  
75-1852-23



**HURD**  
21,0 cm, 8 1/4"  
75-1853-01



**HURD**  
21,0 cm, 8 1/4"  
75-1854-02



**NAGER**  
24,0 cm, 9 1/2"  
75-1855-24



**CLAUS-EICKEN**  
23,0 cm, 9"  
75-1856-23



**FALK**  
24,0 cm, 9 1/2"  
75-1857-01



**FALK**  
24,0 cm, 9 1/2"  
75-1858-02

Unterbindungsnadeln  
Ligature Needles  
Agujas para ligaduras  
Aghi per legatura



**YOUNG-HRYNTSCHAK**  
24,0 cm, 9 1/2"  
75-1844-24



75-1843-01



75-1843-02



75-1843-03



**DE LA ROZA**  
12,0 cm, 4 3/4"  
75-1845-01



**DE LA ROZA**  
12,0 cm, 4 3/4"  
75-1846-02



**JAKOBI**  
14,0 cm, 5 1/2"  
75-1847-14



**HESSEBERG**  
15,0 cm, 6"  
75-1848-15



**KRONECKER**  
15,0 cm, 6"  
75-1849-01

Führungshohlsonden  
Ligature Conductors  
Sondas conductoras  
Sonde conduttrici



**PAYR**  
22,0 cm, 8<sup>5</sup>/<sub>8</sub>"  
75-1860-22



**PAYR**  
22,0 cm, 8<sup>5</sup>/<sub>8</sub>"  
75-1861-22



mit Loch  
with hole  
con foro  
con ago

**SCHMIEDEN-PAYR**  
19,0 cm, 7<sup>1</sup>/<sub>2</sub>"  
75-1862-19



ohne Loch  
without hole  
sin foro  
senza ago

**SCHMIEDEN**  
19,0 cm, 7<sup>1</sup>/<sub>2</sub>"  
75-1863-19



**KÖNIG**  
19,5 cm, 7<sup>3</sup>/<sub>4</sub>"  
75-1864-03



**KÖNIG**  
19,5 cm, 7<sup>3</sup>/<sub>4</sub>"  
75-1865-05



**KÖNIG**  
19,5 cm, 7<sup>3</sup>/<sub>4</sub>"  
75-1866-07

Führungshohlsonden  
Ligature Conductors  
Sondas conductoras  
Sonde conduttrici

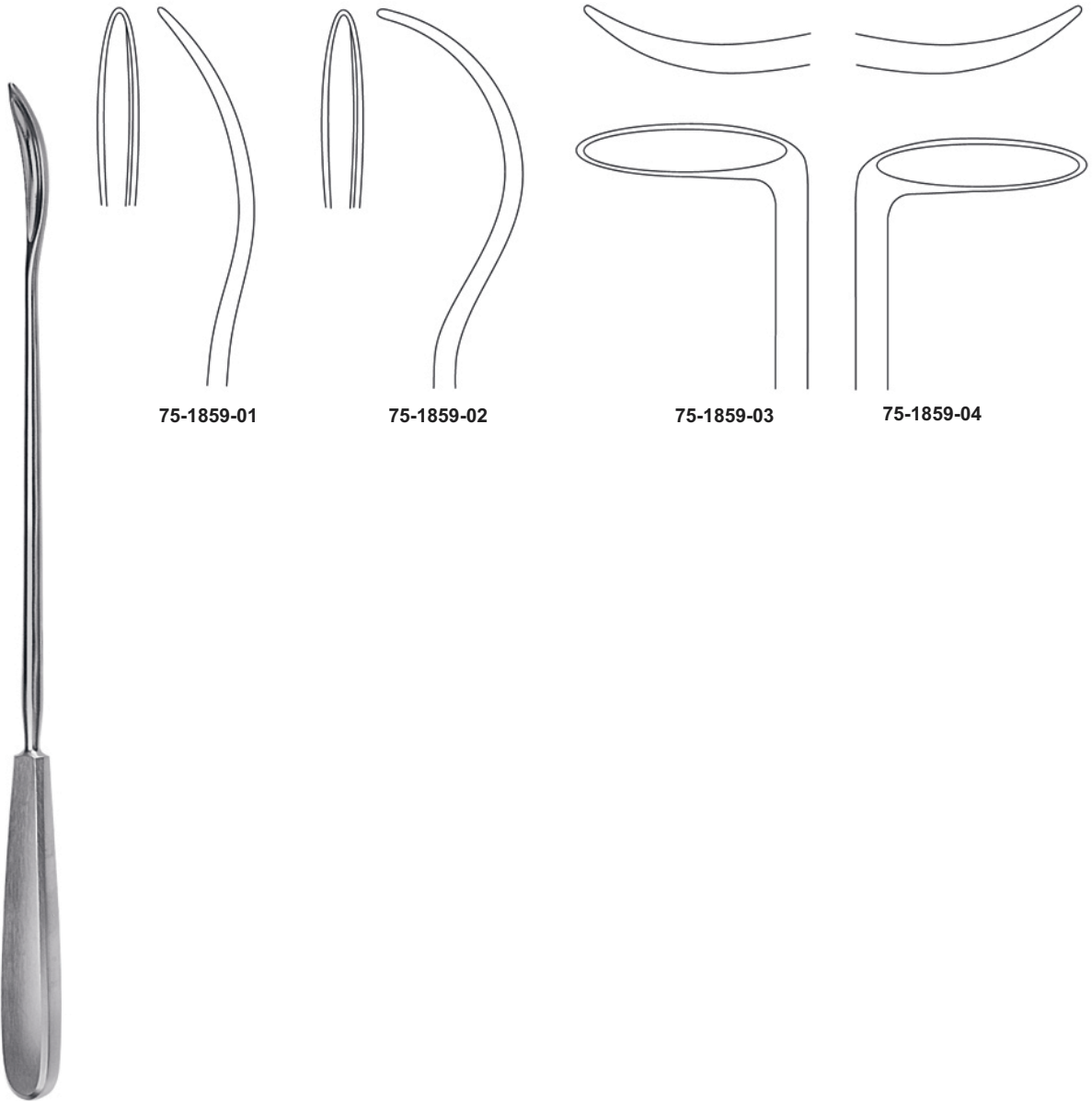

75-1859-01

75-1859-02

75-1859-03

75-1859-04

**BRUNNER**  
30,0 cm, 11<sup>3</sup>/<sub>4</sub>"

Nahtinstrumente  
Suture Instruments  
Instrumentos para sutura  
Strumenti per sutura



**MOD. WIEN**  
23,5 cm, 9<sup>1</sup>/<sub>4</sub>"  
75-1872-23



**BOZEMANN**  
21,0 cm, 8<sup>1</sup>/<sub>4</sub>"  
75-1873-21



23,0 cm, 9"  
75-1874-23



**MICHEL**  
12,0 cm, 4<sup>3</sup>/<sub>4</sub>"  
027-1875-12



**COLLIN**  
13,0 cm, 5"  
75-1876-13



**RICHTER-HEATH**  
14,0 cm, 5<sup>1</sup>/<sub>2</sub>"  
75-1877-14



**WACHENFELDT**  
12,5 cm, 5"  
75-1878-01



**HEGENBARTH**  
12,5 cm, 5"  
75-1879-12



Führungshohlsonden  
Ligature Conductors  
Sondas conductoras  
Sonde conduttrici



**KIRSCHNER**

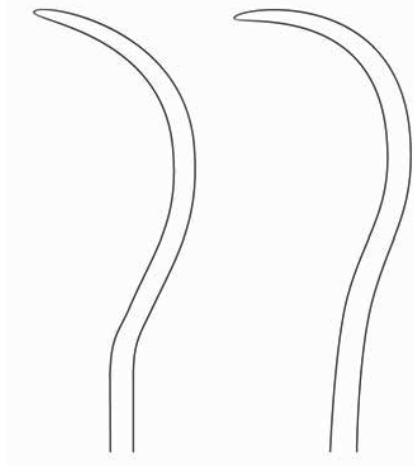

25,5 cm, 10"  
75-1867-25

28,0 cm, 11"  
75-1867-28



**BRUNNER-FERROZELL**

18,0 cm, 7"    75-1868-18  
27,0 cm, 10<sup>5</sup>/<sub>8</sub>"    75-1868-27



**KOCHER**



15,0 cm, 6"    **AK-1869-15 75-1870-15**  
16,0 cm, 6<sup>1</sup>/<sub>4</sub>"    **AK-1869-16 75-1870-16**



18,0 cm, 7"  
75-1871-18



**Wundhaken**  
**Retractors**  
**Separadores**  
**Divaricatori**

Nahtinstrumente  
Suture Instruments  
Instrumentos para sutura  
Strumenti per sutura



**MICHEL**  
12,0 cm, 4<sup>3/4</sup>"  
75-1880-12











**LANGE**  
10,0 cm, 4"  
75-1881-10



**CHILDE**  
18,0 cm, 7"  
75-1882-01



**CHILDE**  
18,0 cm, 7"  
75-1883-02

-  **75-1884-08** 7,5 x 1,75 mm
-  **75-1884-11** 11,0 x 2,0 mm
-  **75-1884-12** 12,0 x 3,0 mm
-  **75-1884-14** 14,0 x 3,0 mm
-  **75-1884-16** 16,0 x 3,0 mm
-  **75-1884-18** 18,0 x 3,0 mm
-  **75-1884-20** 20,0 x 3,0 mm
-  **75-1884-22** 22,0 x 3,0 mm

**MICHEL**



**CLIP-SET**  
**056-558-00**

bestehend aus, consisting of, compuesto de, composto da

- 1 x **75-1885-12**
- 1 x **75-1886-12**
- 50 x **75-1887-14**
- 1 x **75-1888-01** (Etui)

Dura- und Hauthäkchen  
Dura and Skin Retractors  
Gancho para piel y dura-madre  
Unico per pelle e dura-madre



16,0 cm, 6 1/4"



Fig. 1  
75-1899-01



Fig. 2  
75-1900-02



Fig. 3  
75-1901-03



Fig. 4  
75-1902-04



**GUTHRIE**  
16,0 cm, 6 1/4"



Fig. 1  
75-1903-01



Fig. 2  
75-1904-02



**JOSEPH**  
16,0 cm, 6 1/4"



Fig. 1  
75-1905-01



Fig. 2  
75-1906-02



Fig. 3  
75-1907-03



Fig. 4  
75-1908-04

**Dura- und Hauthäkchen**  
**Dura and Skin Retractors**  
**Gancho para piel y dura-madre**  
**Unico per pelle e dura-madre**



**GILLIES**  
18,0 cm, 7"



**KILNER**  
15,0 cm, 6"  
75-1891-15



**FRAZIER**  
13,0 cm, 5"  
75-1892-13



**O'CONNOR**  
16,0 cm, 6 1/4"  
75-1893-16



**KLEINE75-KUTZ**  
16,0 cm, 6 1/4"

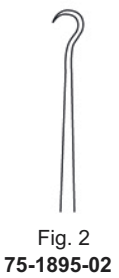

**JOSEPH**  
16,0 cm, 6 1/4"  
75-1898-16



**GRAEFE**  
16,0 cm, 6 1/4"



**Wundhaken  
Retractors  
Separadores  
Divaricatori**

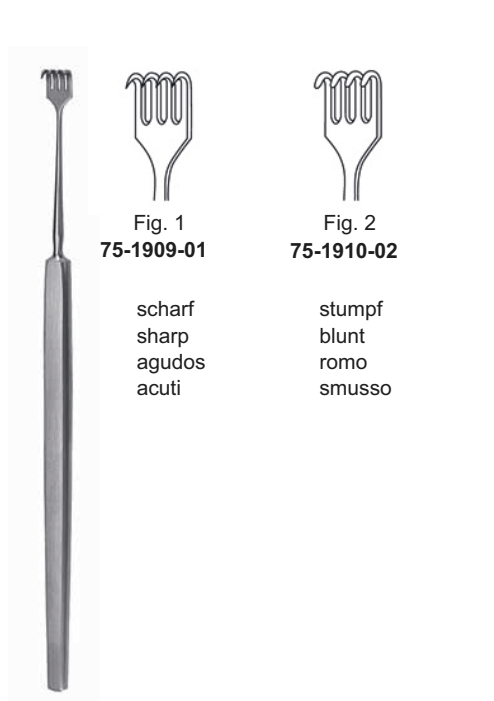

**KNAPP**  
13,0 cm, 5"

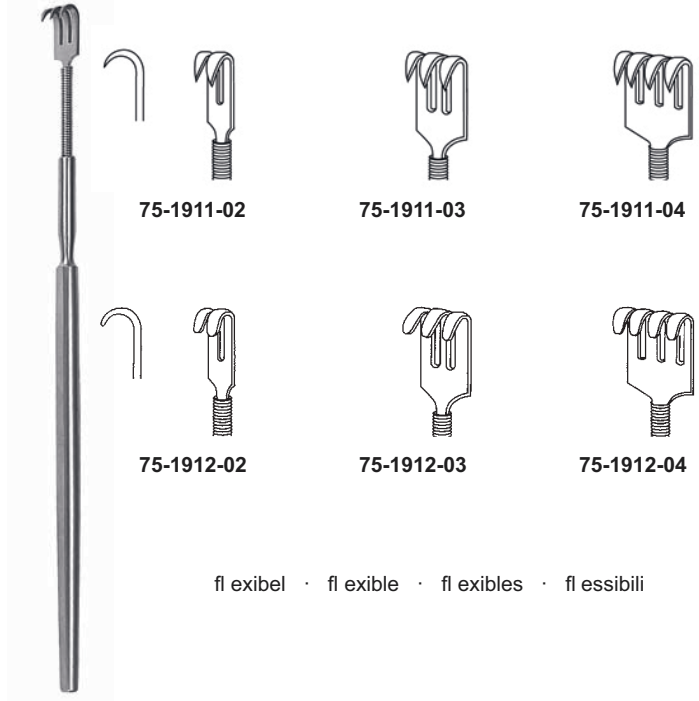

16,0 cm, 6 1/4"

Fig. 1  
75-1909-01

scharf  
sharp  
agudos  
acuti

Fig. 2  
75-1910-02

stumpf  
blunt  
romo  
smusso

75-1911-02

75-1911-03

75-1911-04

75-1912-02

75-1912-03

75-1912-04

fl exibel · fl exible · fl exibles · fl essibili



16,0 cm, 6 1/4"

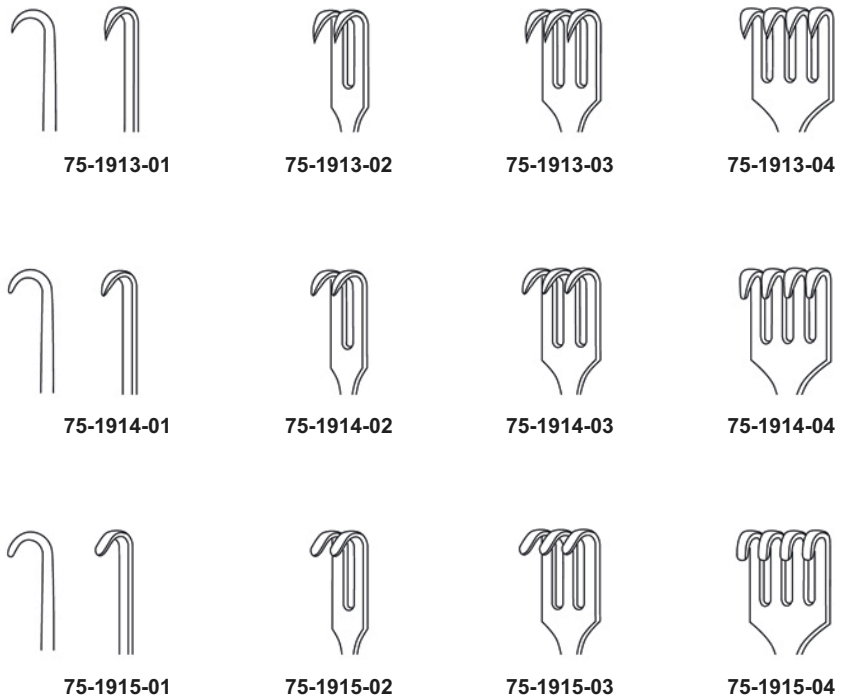

75-1913-01

75-1913-02

75-1913-03

75-1913-04

75-1914-01

75-1914-02

75-1914-03

75-1914-04

75-1915-01

75-1915-02

75-1915-03

75-1915-04

scharf  
sharp  
agudos  
acuti

halbscharf  
semi-sharp

semi-acuti  
semi-agudos

stumpf  
blunt  
romo  
smusso

**Wundhaken  
Retractors  
Separadores  
Divaricatori**



16,0 cm, 6<sup>1</sup>/<sub>4</sub>"

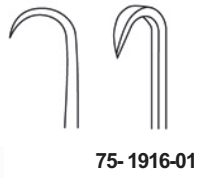

scharf  
sharp  
agudos  
acuti

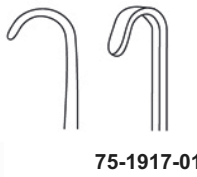

stumpf  
blunt  
romo  
smusso



**CUSHING**  
19,0 cm, 7<sup>1</sup>/<sub>2</sub>"

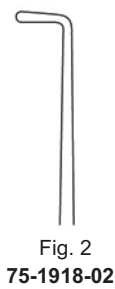
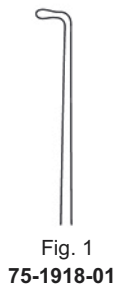

**LANGENBECK-GREEN**  
16,0 cm, 6<sup>1</sup>/<sub>4</sub>"

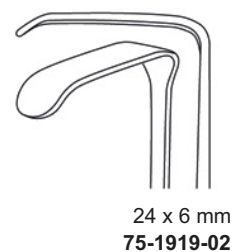
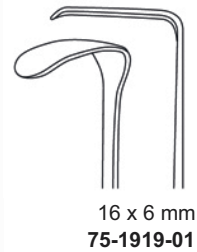

Wundhaken  
Retractors  
Separadores  
Divaricatori



**MEYERDING**  
18,0 cm, 7"



18 x 7 mm  
75-1920-01



16 x 5 mm  
75-1920-02



7 x 4 mm  
75-1920-03



10 x 3 mm  
75-1921-04



7 x 4 mm  
75-1921-05



4 x 10 mm  
75-1921-06



16,0 cm, 6 1/4"



14 x 8 mm  
75-1923-16



**SENN-GREEN**  
15,0 cm, 6"



10 x 6 mm  
75-1924-10



20 x 6 mm  
75-1924-20



**MINI-LANGENBECK**  
16,0 cm, 6 1/4"



10 x 6 mm  
75-1925-01

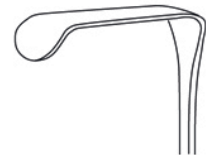

17 x 5 mm  
75-1925-02



20 x 6 mm  
75-1926-03



22 x 8 mm  
75-1926-04



Wundhaken  
Retractors  
Separadores  
Divaricatori



**RAGNELL-DAVIS**  
14,0 cm, 5 1/2"  
75-1927-14



**RAGNELL**  
15,0 cm, 6"  
75-1928-15

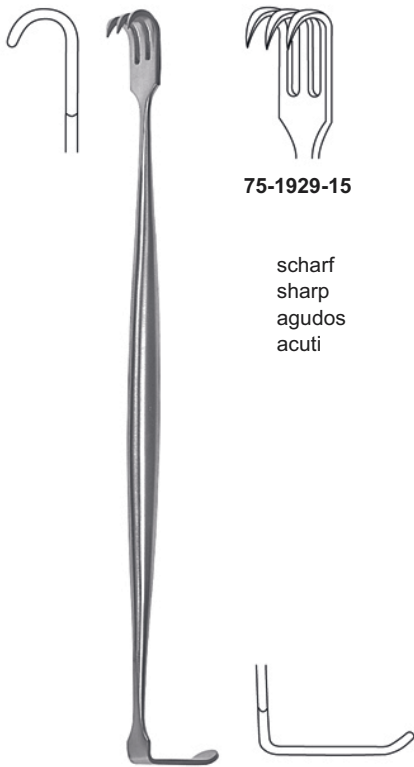

**BABY SENN-MILLER**  
15,0 cm, 6"

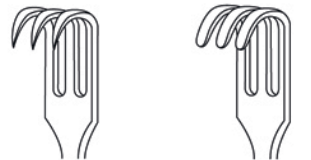

75-1929-15

scharf  
sharp  
agudos  
acuti

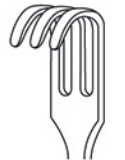

75-1930-15

stumpf  
blunt  
romo  
smusso

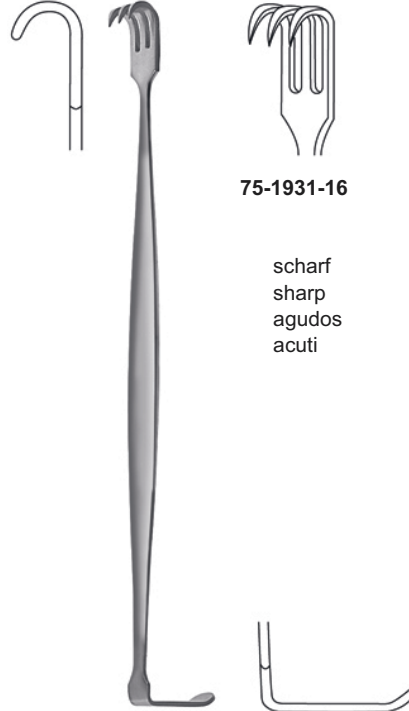

**SENN-MILLER**  
16,0 cm, 6 1/4"

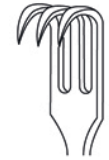

75-1931-16

scharf  
sharp  
agudos  
acuti



75-1932-16

stumpf  
blunt  
romo  
smusso

Wundhaken  
Retractors  
Separadores  
Divaricatori



**DESMARRES**  
13,0 cm, 5"



8 mm  
**75-1933-08**



10 mm  
**75-1933-10**



12 mm  
**75-1933-12**



14 mm  
**75-1933-14**

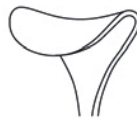

16 mm  
**75-1933-16**

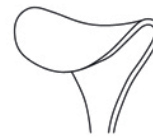

18 mm  
**75-1933-18**



**DESMARRES**  
16,0 cm, 6 1/4"



8 mm  
**75-1934-08**



10 mm  
**75-1934-10**



12 mm  
**75-1934-12**



14 mm  
**75-1934-14**



16 mm  
**75-1934-16**

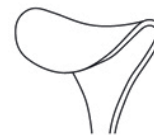

18 mm  
**75-1934-18**

Wundhaken  
Retractors  
Separadores  
Divaricatori

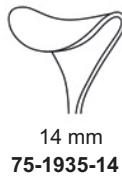

**CUSHING**  
20,0 cm, 8"

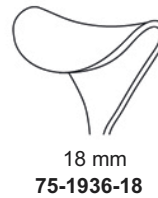
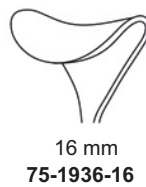
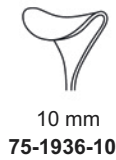

**CUSHING**  
24,0 cm, 9 1/2"

**Wundhaken  
Retractors  
Separadores  
Divaricatori**



**ROUX**  
75-1939-00

- Fig. 1 24 x 20 mm
- Fig. 2 29 x 26 mm
- Fig. 3 33 x 29 mm
- Fig. 4 29 x 24 mm

Satz, Fig. 1-3  
Set, fig. 1-3  
Juego, fig. 1-3  
Serie, fig. 1-3

- Fig. 1 30 x 28 mm
- Fig. 2 36 x 36 mm
- Fig. 3 38 x 43 mm
- Fig. 4 45 x 28 mm

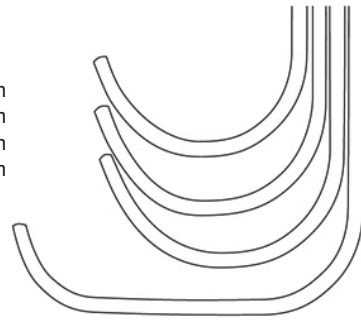
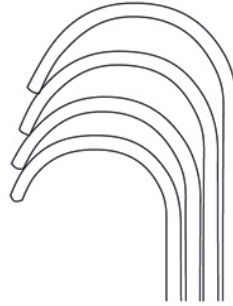

- |          |  |                   |
|----------|--|-------------------|
| Fig. 1-3 | 17,0 cm, 6 <sup>3</sup> / <sub>4</sub> " | <b>75-1940-00</b> |
| Fig. 1   | 14,0 cm, 5 <sup>1</sup> / <sub>2</sub> " | <b>75-1940-01</b> |
| Fig. 2   | 15,0 cm, 6"                              | <b>75-1940-02</b> |
| Fig. 3   | 17,0 cm, 6 <sup>3</sup> / <sub>4</sub> " | <b>75-1940-03</b> |
| Fig. 4   | 18,0 cm, 7"                              | <b>75-1940-04</b> |



**FARABEUF**  
12,0 cm, 4<sup>3</sup>/<sub>4</sub>"  
75-1941-12

- Fig. 2 30 x 10 mm
- Fig. 1 26 x 10 mm

- Fig. 1 30 x 13 mm
- Fig. 2 34 x 13 mm

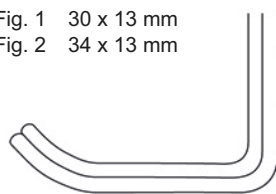

**FARABEUF**  
15,0 cm, 5<sup>3</sup>/<sub>4</sub>"  
75-1941-15

- Fig. 2 23 x 16 mm
- Fig. 1 27 x 16 mm

- Fig. 1 26 x 16 mm
- Fig. 2 30 x 16 mm

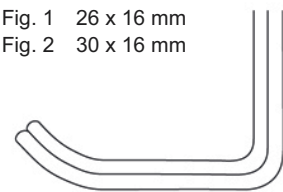
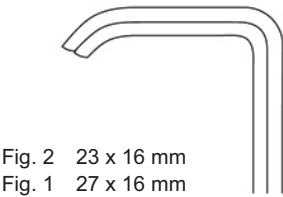

Wundhaken  
Retractors  
Separadores  
Divaricatori



**GIL-VERNET**  
24,0 cm, 9 1/2"

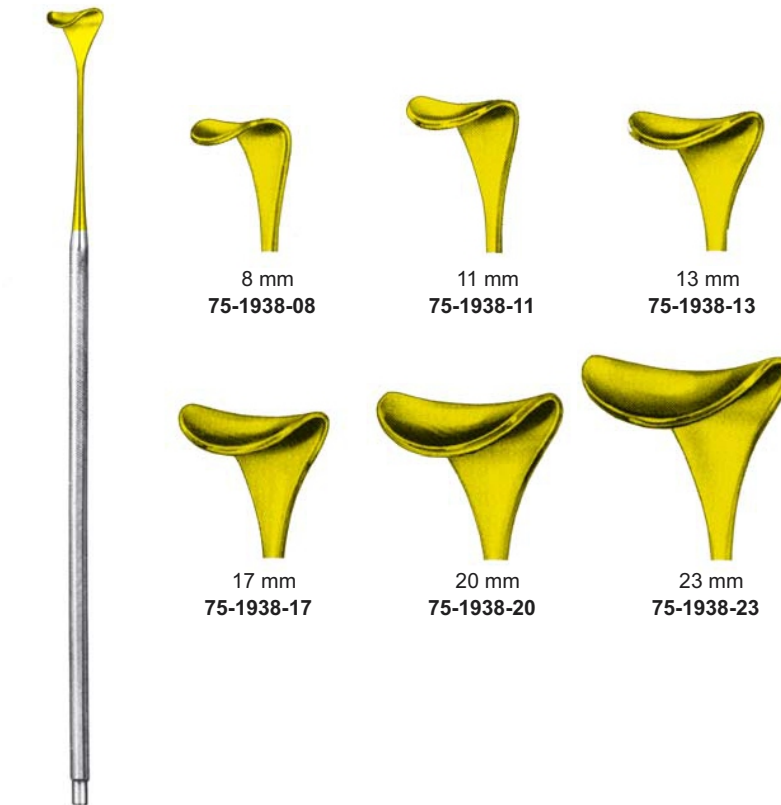

**GIL-VERNET**  
24,0 cm, 9 1/2"

Wundhaken  
Retractors  
Separadores  
Divaricatori



**GOELET**  
19,0 cm, 7 1/2"  
75-1947-19

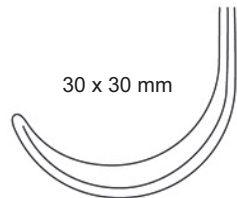
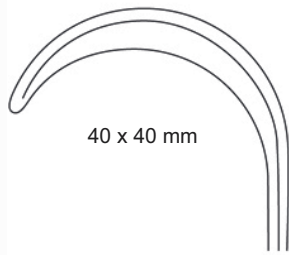

**PARKER-LANGENBECK**  
21,0 cm, 8 1/4"  
75-1948-00

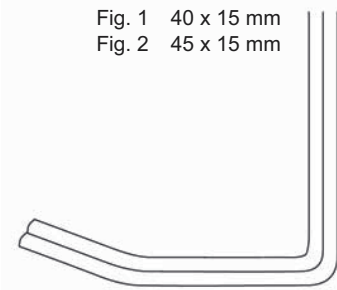
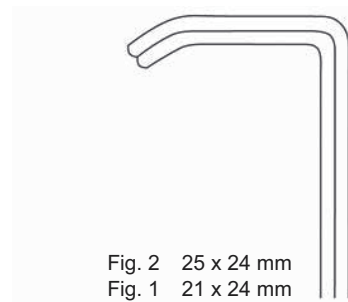

**CANNY RYAL**

16 mm	19,0 cm, 7 1/2"	<b>75-1949-16</b>
20 mm	19,0 cm, 7 1/2"	<b>75-1949-20</b>
25 mm	20,0 cm, 8"	<b>75-1949-25</b>

Wundhaken  
Retractors  
Separadores  
Divaricatori



**MINI-ROUX**  
14,0 cm, 5 1/2"  
75-1942-06



**BABY-ROUX**  
13,0 cm, 5"  
75-1943-13

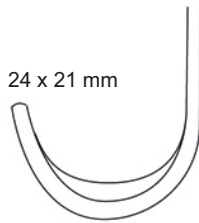

**PARKER**  
13,5 cm, 5 3/8"  
75-1944-00

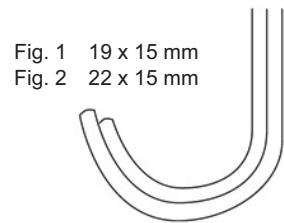
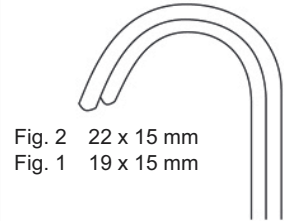

**CZERNY**  
17,5 cm, 7"  
75-1945-00

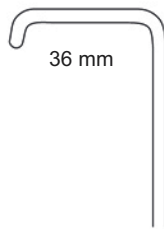

**MATHIEU**  
20,0 cm, 8"  
75-1946-00

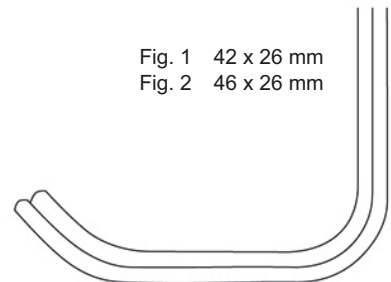
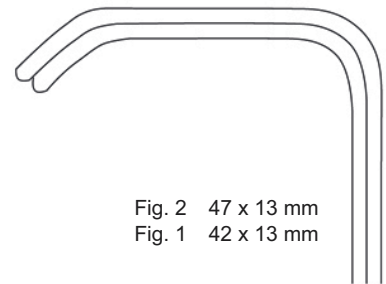

**Wundhaken**  
**Retractors**  
**Separadores**  
**Divaricatori**



**VOLKMANN**  
21,5 cm, 8½"



**75-1952-01**



9 x 8 mm  
**75-1952-02**



9 x 13 mm  
**75-1952-03**



9 x 19 mm  
**75-1952-04**



9 x 29 mm  
**75-1952-06**

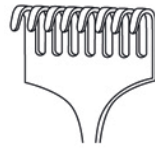

9 x 40 mm  
**75-1952-08**

stumpf  
blunt  
romo  
smusso



**75-1953-01**



9 x 8 mm  
**75-1953-02**



15 x 15 mm  
**75-1953-03**



15 x 20 mm  
**75-1953-04**



15 x 30 mm  
**75-1953-06**

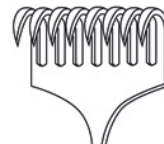

15 x 40 mm  
**75-1953-08**

scharf  
sharp  
agudos  
acuti



**KOCHER**  
22,0 cm, 8⅝"



Wundhaken  
Retractors  
Separadores  
Divaricatori



**VOLKMANN**  
21,5 cm, 8 1/2"



**75-1950-01**



9 x 8 mm  
**75-1950-02**



9 x 13 mm  
**75-1950-03**



9 x 19 mm  
**75-1950-04**



9 x 29 mm  
**75-1950-06**

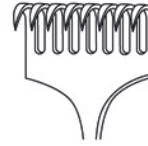

9 x 40 mm  
**75-1950-08**

scharf  
sharp  
agudos  
acuti



**VOLKMANN**  
21,5 cm, 8 1/2"



**75-1951-01**



9 x 8 mm  
**75-1951-02**



9 x 13 mm  
**75-1951-03**



9 x 19 mm  
**75-1951-04**



9 x 29 mm  
**75-1951-06**

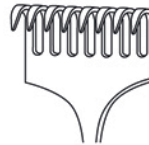

9 x 40 mm  
**75-1951-08**

halbscharf  
semi-sharp  
semi-agudos  
semi-acuti

Wundhaken  
Retractors  
Separadores  
Divaricatori

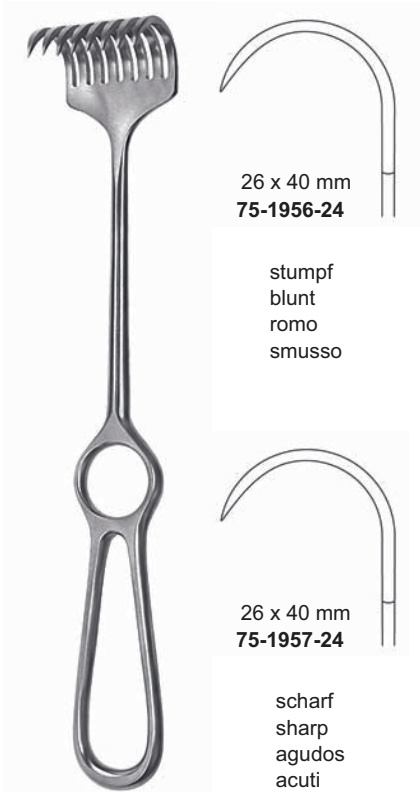

**KOERTE**  
24,0 cm, 9½"

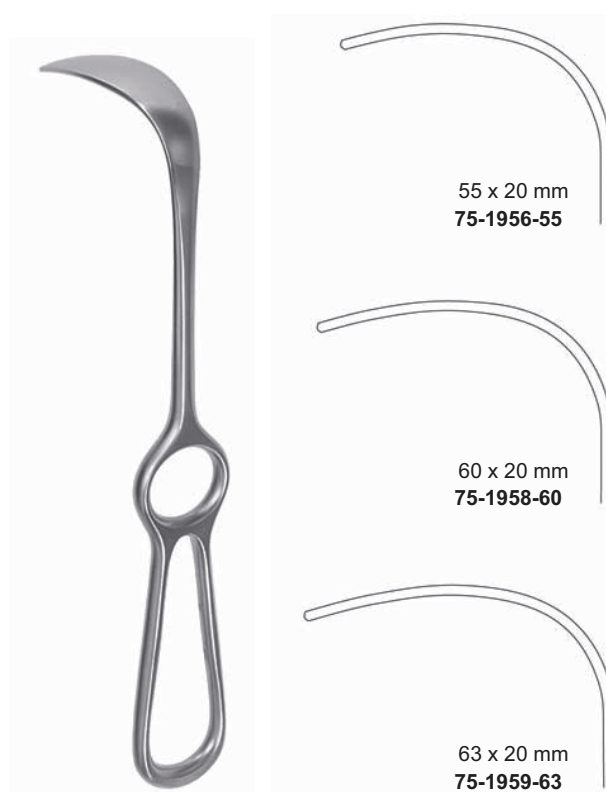

**LANGENBECK**  
21,0 cm, 8¼"



**ISRAEL**  
25,0 cm, 9¾"

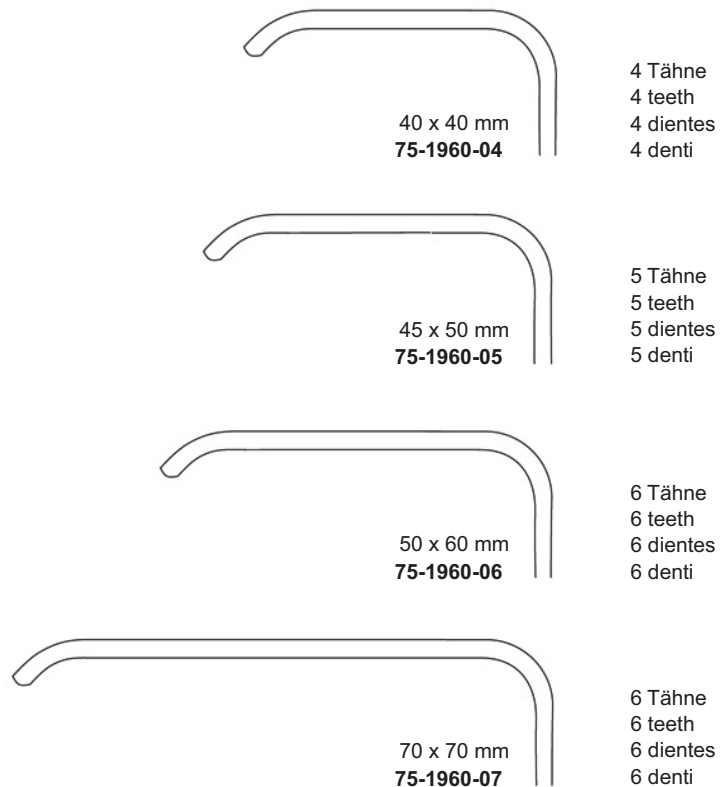

Wundhaken  
Retractors  
Separadores  
Divaricatori



**KOCHER**  
22,0 cm, 8<sup>5</sup>/<sub>8</sub>"



75-1954-01



9 x 8 mm  
75-1954-02



15 x 15 mm  
75-1954-03



15 x 20 mm  
75-1954-04

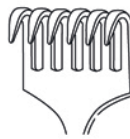

15 x 30 mm  
75-1954-06

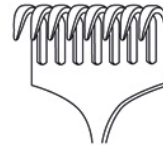

15 x 40 mm  
75-1954-08

halbscharf  
semi-sharp  
semi-agudos  
semi-acuti



**KOCHER**  
22,0 cm, 8<sup>5</sup>/<sub>8</sub>"



75-1955-01



9 x 8 mm  
75-1955-02



15 x 15 mm  
75-1955-03



15 x 20 mm  
75-1955-04

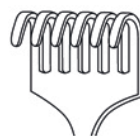

15 x 30 mm  
75-1955-06

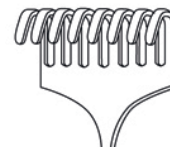

15 x 40 mm  
75-1955-08

stumpf  
blunt  
romo  
smusso

**Wundhaken  
Retractors  
Separadores  
Divaricatori**



**KOCHER-LANGENBECK**  
21,5 cm, 8½"



22 x 6 mm  
**75-1963-22**



25 x 6 mm  
**75-1963-25**



25 x 8 mm  
**75-1963-26**



35 x 8 mm  
**75-1963-35**



35 x 11 mm  
**75-1963-36**



35 x 15 mm  
**75-1963-37**



40 x 11 mm  
**75-1963-40**



70 x 15 mm  
**75-1963-70**



80 x 12 mm  
**75-1963-80**



80 x 15 mm  
**75-1963-85**

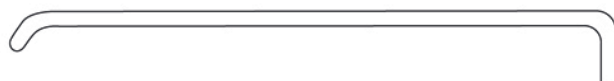

22 x 6 mm  
**75-1963-22**

Wundhaken  
Retractors  
Separadores  
Divaricatori



**LANGENBECK**  
22,0 cm, 8<sup>5</sup>/<sub>8</sub>"



30 x 11 mm  
75-1961-30

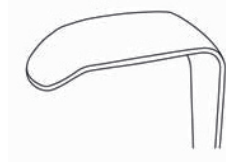

30 x 14 mm  
75-1961-31



30 x 16 mm  
75-1961-32

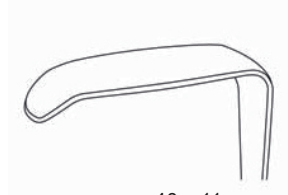

40 x 11 mm  
75-1961-40



50 x 11 mm  
75-1961-50



**LANGENBECK**  
22,0 cm, 8<sup>5</sup>/<sub>8</sub>"

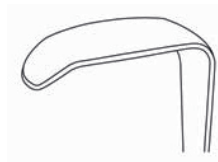

30 x 11 mm  
75-1962-30



30 x 14 mm  
75-1962-31



30 x 16 mm  
75-1962-32

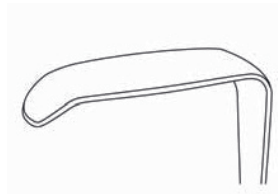

40 x 11 mm  
75-1962-40

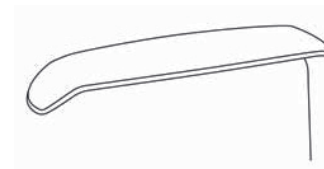

50 x 11 mm  
75-1962-50

Wundhaken  
Retractors  
Separadores  
Divaricatori



**MIDDELDORPF**



21,5 cm, 8 1/2"  
14 x 17 mm  
**75-1966-01**



22,0 cm, 8 5/8"  
20 x 22 mm  
**75-1966-02**



23,5 cm, 9 1/4"  
26 x 30 mm  
**75-1966-03**



**MIDDELDORPF**



21,5 cm, 8 1/2"  
14 x 17 mm  
**75-1967-01**



22,0 cm, 8 5/8"  
20 x 22 mm  
**75-1967-02**



23,5 cm, 9 1/4"  
26 x 30 mm  
**75-1967-03**



**RICHARDSON (KELLY)**  
24,0 cm, 9 1/2"



**75-1968-01**



9 x 8 mm  
**75-1968-02**



15 x 15 mm  
**75-1968-03**

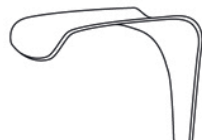

15 x 20 mm  
**75-1968-04**

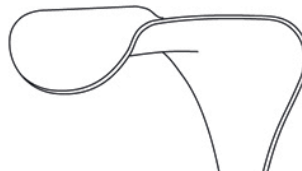

15 x 30 mm  
**75-1968-06**



15 x 40 mm  
**75-1968-08**

Wundhaken  
Retractors  
Separadores  
Divaricatori



**KOCHER**  
23,0 cm, 9"

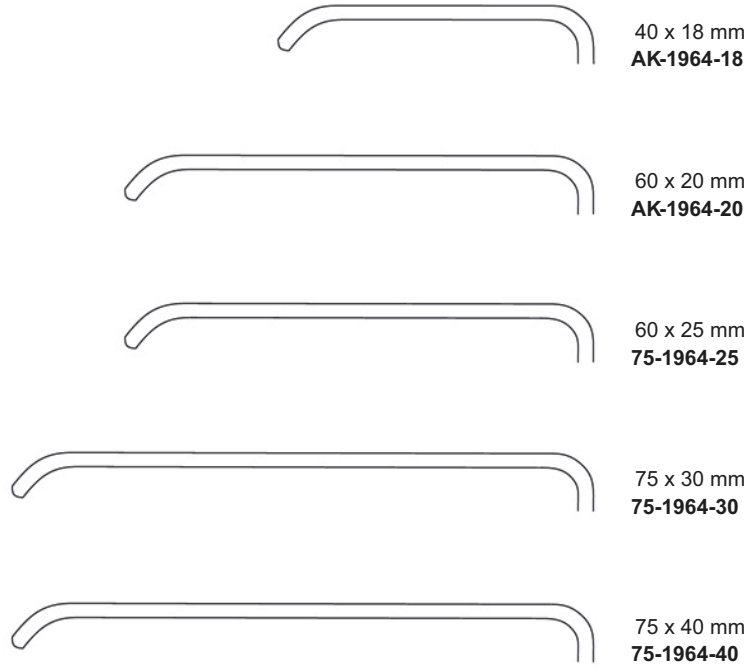

**SAUERBRUCH**  
22,5 cm, 8<sup>3</sup>/<sub>4</sub>"

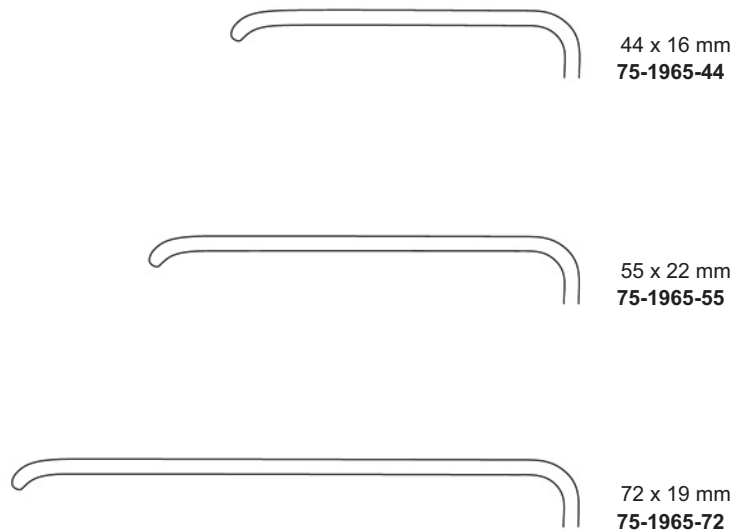

**Wundhaken  
Retractors  
Separadores  
Divaricatori**

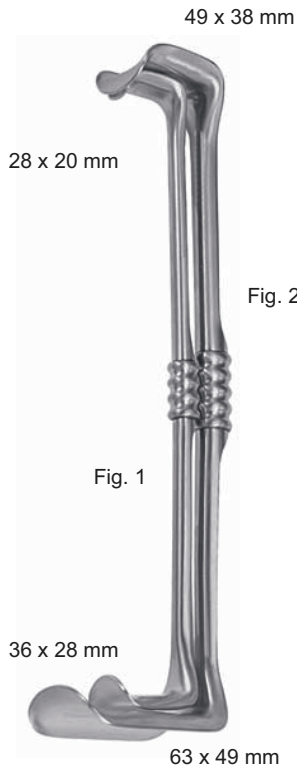
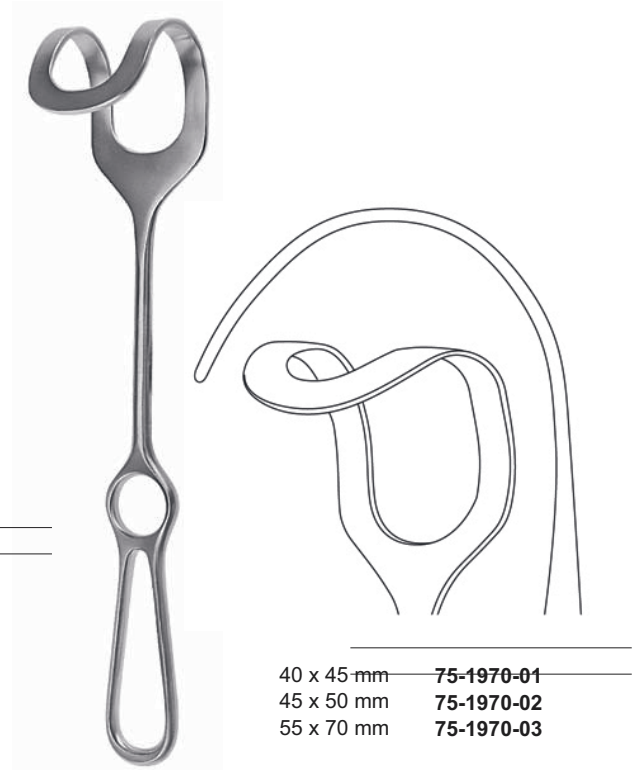

Fig. 2

Fig. 1+2 28,0 cm, 11" **75-1969-00**  
 Fig. 1 26,0 cm, 10<sup>1</sup>/<sub>4</sub>" **75-1969-01**  
 Fig. 2 28,0 cm, 11" **75-1969-02**



**75-1970-01**  
**75-1970-02**  
**75-1970-03**

**RICHARDSON-EASTMAN**

**MIDDELDORPF**  
25,5 cm, 10"



**FRITSCH**  
24,0 cm, 9<sup>1</sup>/<sub>2</sub>"



**DOYEN**  
25,0 cm, 10"  
**75-1972-86**



Wundhaken  
Retractors  
Separadores  
Divaricatori



**DOYEN-STILLE**  
22,0 cm, 8<sup>5</sup>/<sub>8</sub>"

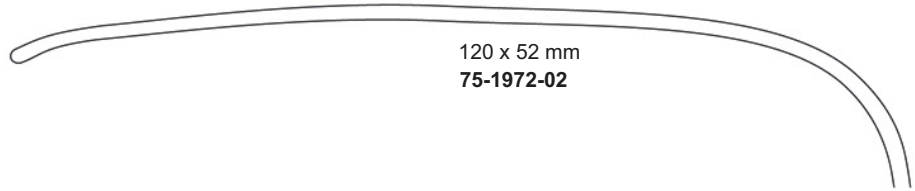

120 x 52 mm  
75-1972-02

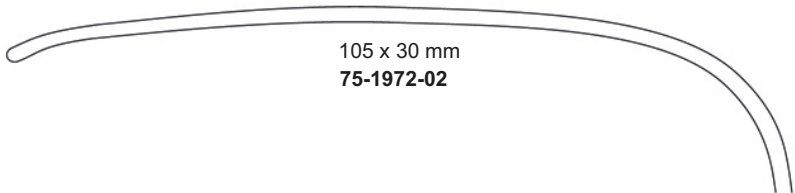

105 x 30 mm  
75-1972-02

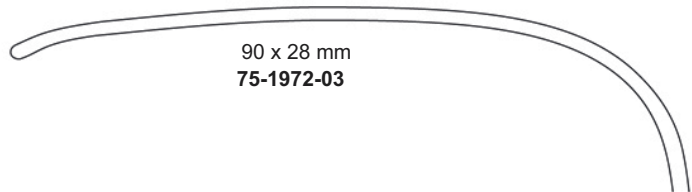

90 x 28 mm  
75-1972-03

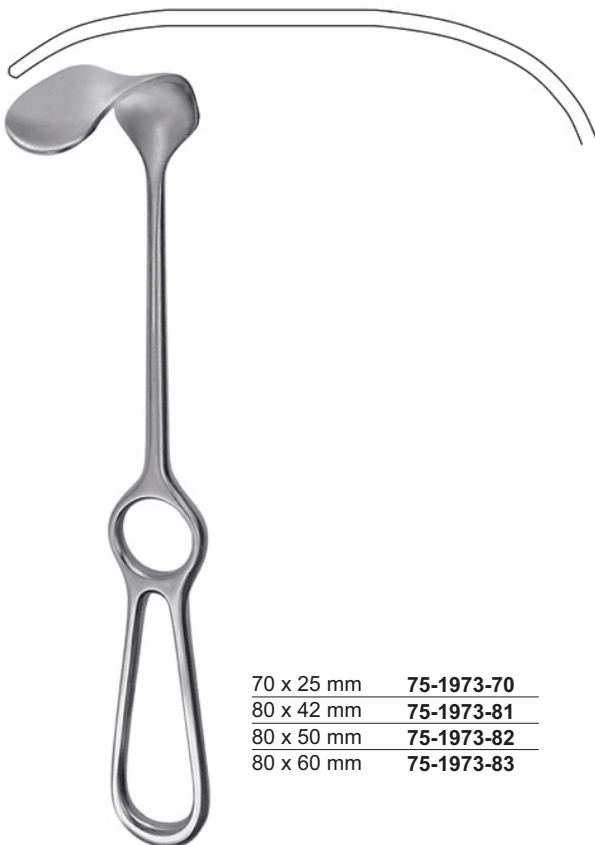

**KOCHER**  
25,0 cm, 10"

- |            |            |
|------------|------------|
| 70 x 25 mm | 75-1973-70 |
| 80 x 42 mm | 75-1973-81 |
| 80 x 50 mm | 75-1973-82 |
| 80 x 60 mm | 75-1973-83 |



**LAHEY**  
19,0 cm, 7<sup>1</sup>/<sub>2</sub>"  
75-1974-19

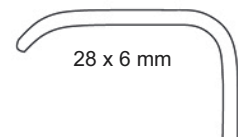

28 x 6 mm

Wundhaken  
Retractors  
Separadores  
Divaricatori



**LITTLE**  
20,0 cm, 8"  
75-1976-20



115 x 22 mm **75-1975-01**  
115 x 27 mm **75-1975-02**

**SIMON**  
28,0 cm, 11"

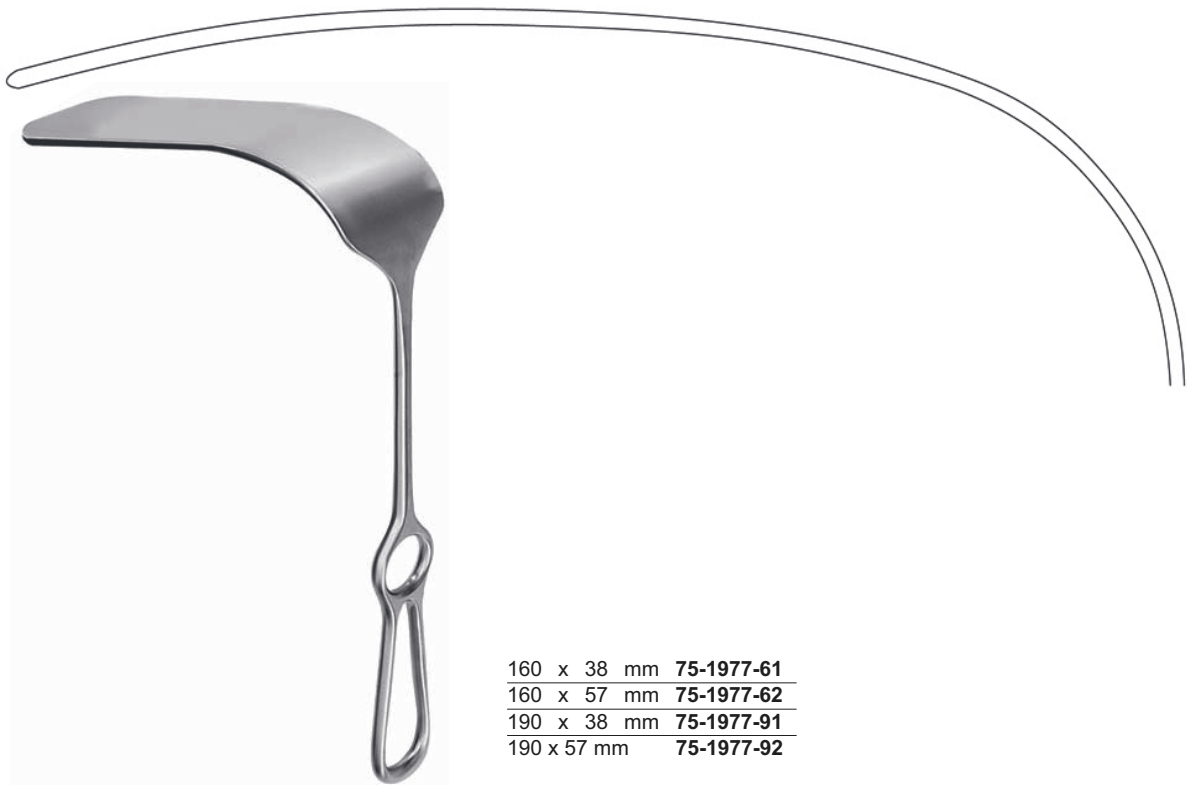

**KELLY**  
27,0 cm, 10 1/2"

160 x 38 mm **75-1977-61**  
160 x 57 mm **75-1977-62**  
190 x 38 mm **75-1977-91**  
190 x 57 mm **75-1977-92**

Wundhaken  
Retractors  
Separadores  
Divaricatori



85 x 35 mm	<b>75-1978-01</b>
120 x 50 mm	<b>75-1978-02</b>
155 x 50 mm	<b>75-1978-03</b>

**MIKULICZ**  
26,0 cm, 10<sup>1</sup>/<sub>4</sub>"



90 x 50 mm

**MIKULICZ**  
26,0 cm, 10<sup>1</sup>/<sub>4</sub>"  
**75-1980-90**



70 x 38 mm	<b>75-1979-38</b>
70 x 50 mm	<b>75-1979-51</b>

**MORRIS**  
24,5 cm, 9<sup>5</sup>/<sub>8</sub>"

Wundhaken  
Retractors  
Separadores  
Divaricatori



127 x 40 mm **75-1982-40**  
127 x 62 mm **75-1982-62**

82 x 22 mm **75-1981-01**  
108 x 43 mm **75-1981-02**  
115 x 65 mm **75-1981-03**

**HARRINGTON**  
32,0 cm, 12 1/2"

**CORYKKOS**  
24,0 cm, 9 1/2"



**ZENKER**

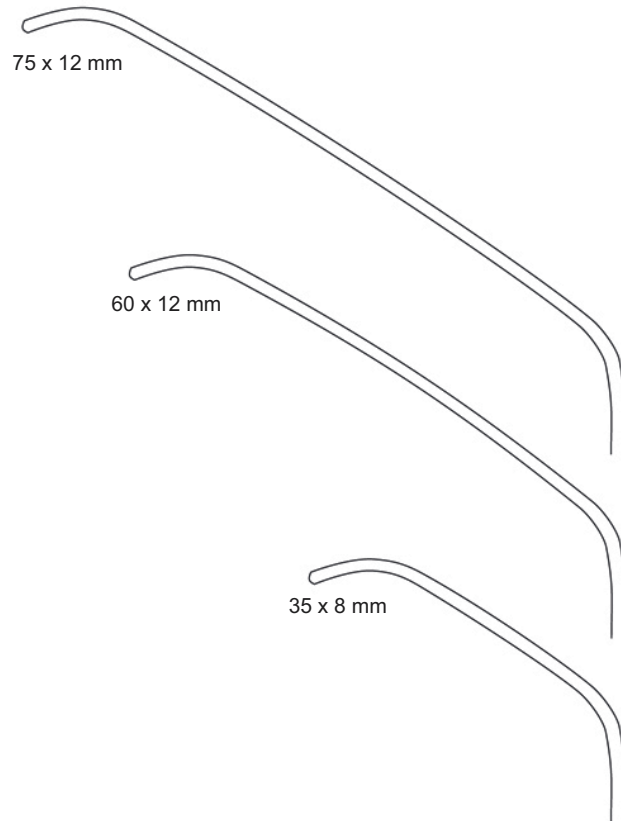

75 x 12 mm

60 x 12 mm

35 x 8 mm

25,0 cm, 9 3/4"  
**75-1983-25**

26,0 cm, 10 1/4"  
**75-1983-26**

27,5 cm, 10 3/4"  
**75-1983-27**

**Wundhaken  
Retractors  
Separadores  
Divaricatori**



**MEYERDING**  
22,5 cm, 8<sup>3</sup>/<sub>4</sub>"

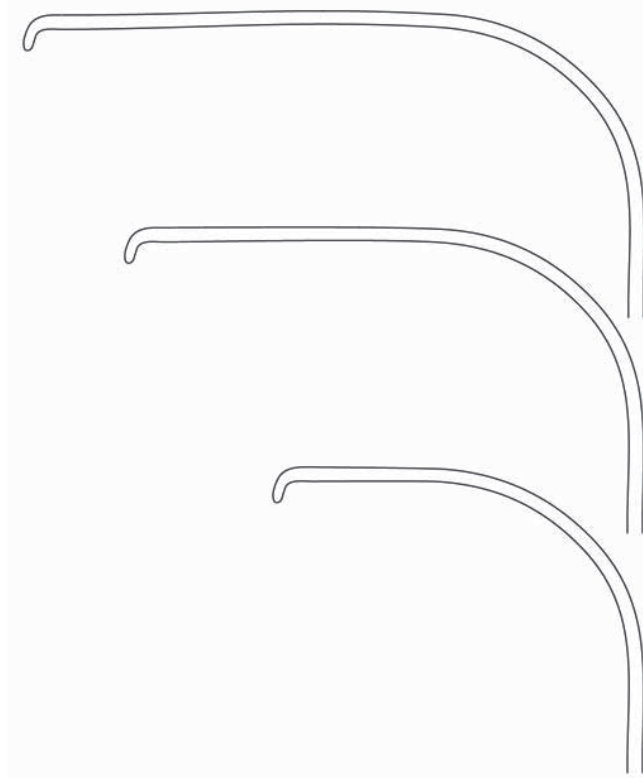

90 x 50 mm  
**75-1984-50**

75 x 25 mm  
**75-1984-25**

50 x 16 mm  
**75-1984-16**



**BRUNNER**  
25,0 cm, 10"

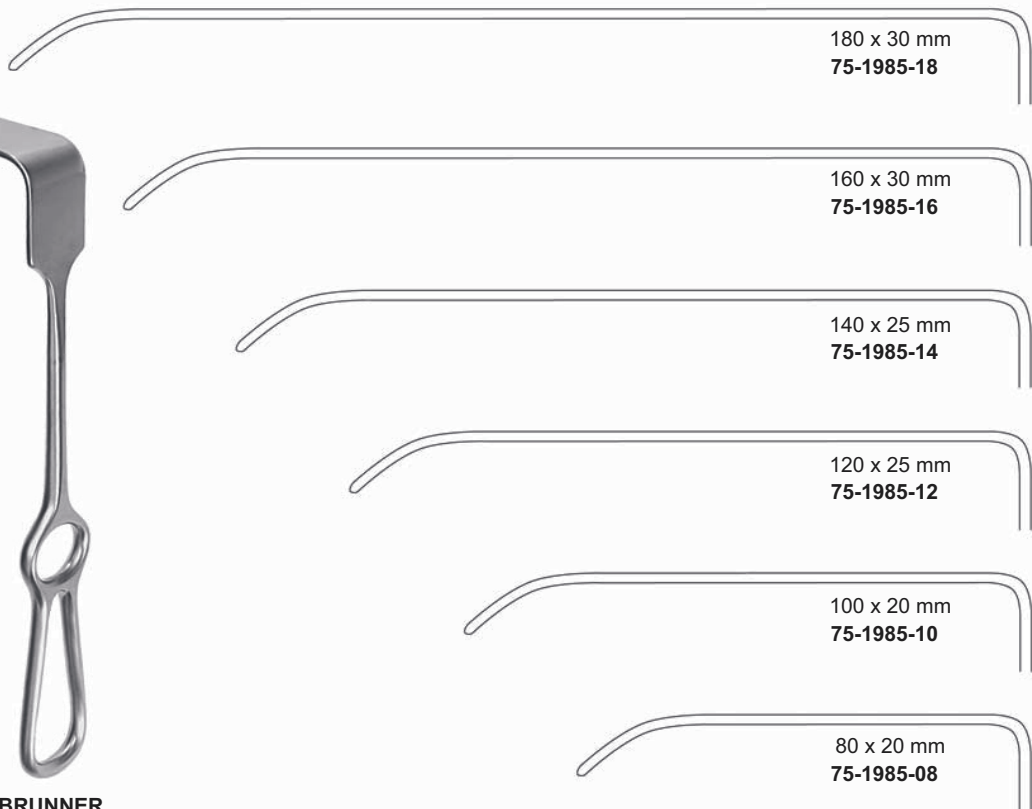

180 x 30 mm  
**75-1985-18**

160 x 30 mm  
**75-1985-16**

140 x 25 mm  
**75-1985-14**

120 x 25 mm  
**75-1985-12**

100 x 20 mm  
**75-1985-10**

80 x 20 mm  
**75-1985-08**

Wundhaken  
Retractors  
Separadores  
Divaricatori

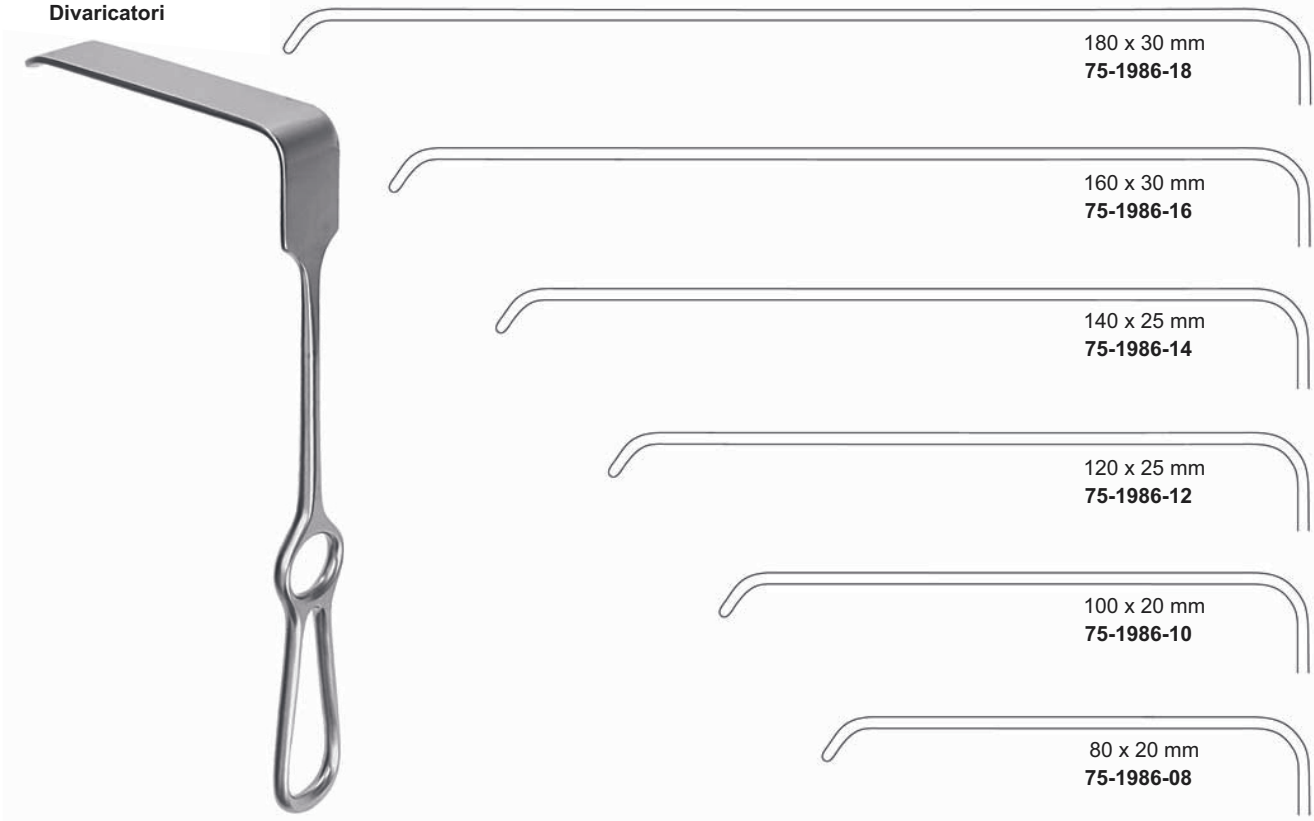

**BRUNNER**  
25,0 cm, 10"

180 x 30 mm  
75-1986-18

160 x 30 mm  
75-1986-16

140 x 25 mm  
75-1986-14

120 x 25 mm  
75-1986-12

100 x 20 mm  
75-1986-10

80 x 20 mm  
75-1986-08



19 mm

**DEAVER**  
18,0 cm, 7"  
75-1987-18



22 mm

**DEAVER**  
21,5 cm, 8½"  
75-1987-22

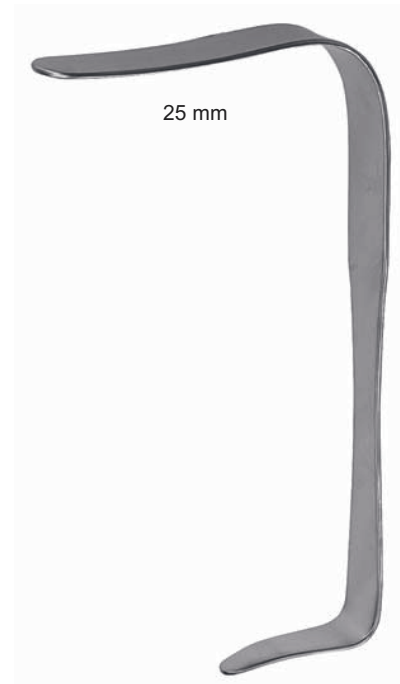

25 mm

**DEAVER**  
23,0 cm, 9"  
75-1987-23

Wundhaken  
Retractors  
Separadores  
Divaricatori

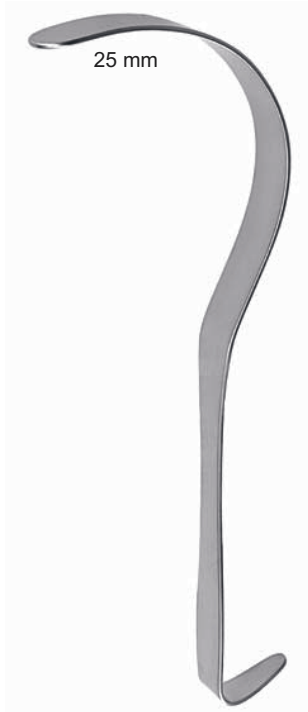

**DEAVER**  
30,0 cm, 11<sup>3</sup>/<sub>4</sub>"  
75-1987-30



**DEAVER**  
33,0 cm, 13"  
75-1987-33



**DEAVER**  
36,0 cm, 14<sup>1</sup>/<sub>8</sub>"  
75-1987-36



**DEAVER**  
30,0 cm, 11<sup>3</sup>/<sub>4</sub>"  
75-1987-38



**DEAVER**  
30,0 cm, 11<sup>3</sup>/<sub>4</sub>"  
75-1987-50



**DEAVER**  
30,0 cm, 11<sup>3</sup>/<sub>4</sub>"  
75-1987-75

Wundhaken  
Retractors  
Separadores  
Divaricatori



25 mm	75-1988-25
38 mm	75-1988-38
50 mm	75-1988-50
75 mm	75-1988-75

**DEAVER GRIP**  
30,0 cm, 11<sup>3</sup>/<sub>4</sub>"



**ALLISON**

40 mm	30,0 cm, 11 <sup>3</sup> / <sub>4</sub> "	75-1989-30
54 mm	32,0 cm, 12 <sup>1</sup> / <sub>2</sub> "	75-1989-32



**DAVIDSON**

75 x 50 mm	16,0 cm, 6 <sup>1</sup> / <sub>4</sub> "	75-1990-50
75 x 90 mm	16,0 cm, 6 <sup>1</sup> / <sub>4</sub> "	75-1990-90



**ST MARKS**

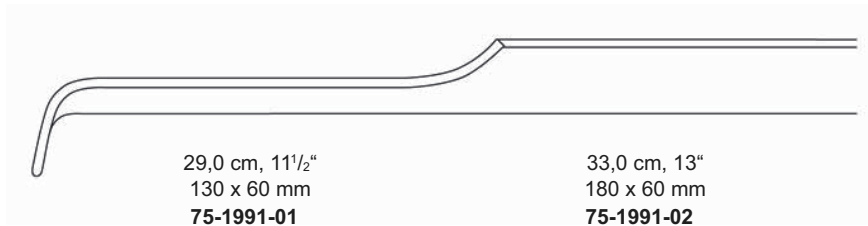

29,0 cm, 11<sup>1</sup>/<sub>2</sub>"  
130 x 60 mm  
75-1991-01

33,0 cm, 13"  
180 x 60 mm  
75-1991-02



29,0 cm, 11<sup>1</sup>/<sub>2</sub>"  
130 x 60 mm  
75-1992-01

33,0 cm, 13"  
180 x 60 mm  
75-1992-02





**Wundspreizer**

**Self-Retaining Retractors**

**Separadores con retenida automática**

**Divaricatori autoctatici**

**Wundspreizer**  
**Self-Retaining Retractors**  
**Separadores con retenida automática**  
**Divaricatori autostatici**

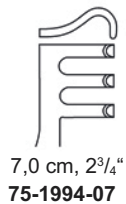
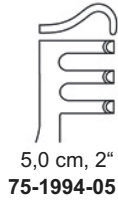
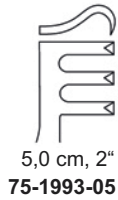

scharf  
 sharp  
 agudos  
 acuti

stumpf  
 blunt  
 romo  
 smusso



**FINSEN**



**JANSEN**  
 10,0 cm, 4"

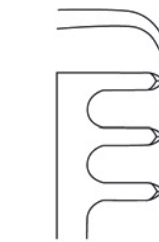

scharf  
 sharp  
 agudos  
 acuti

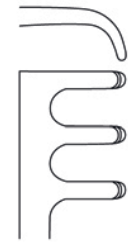

stumpf  
 blunt  
 romo  
 smusso



**ALM**

scharf  
 sharp  
 agudos  
 acuti

halbscharf  
 semi-sharp  
 semi-agudos  
 semi-acuti

stumpf  
 blunt  
 romo  
 smusso

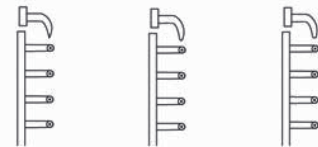

7,0 cm, 2<sup>3</sup>/<sub>4</sub>" **75-1997-07** **75-1998-07** **75-1999-07**  
 10,0 cm, 4" **75-2000-10** **75-2001-10** **75-2002-10**



**ALLPORT**  
 9,5 cm, 3<sup>3</sup>/<sub>4</sub>"  
**75-2003-09**

**Wundspreizer**  
**Self-Retaining Retractors**  
**Separadores con retenida automática**  
**Divaricatori autostatici**



**SALP-CONTOUR**  
14,0 cm, 5½"

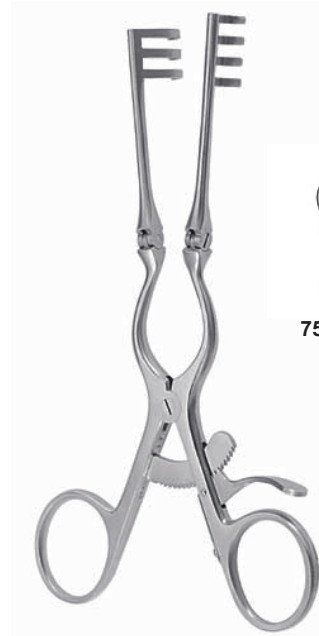
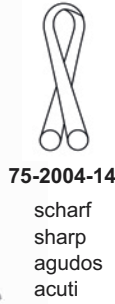

**ADSON-BABY**  
16,0 cm, 6¼"



**ANDERSON-ADSON**  
20,0 cm, 8"

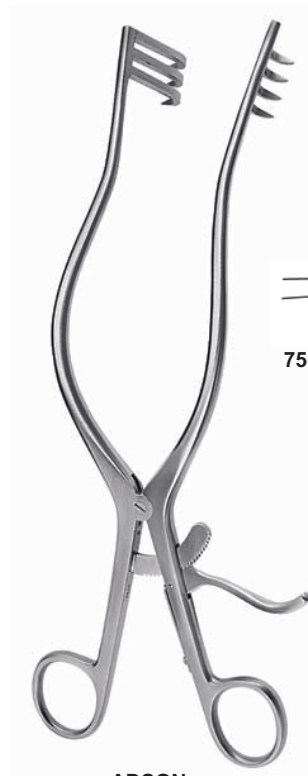

**ADSON**  
26,5 cm, 10½"

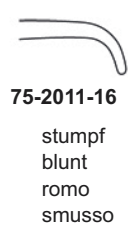

**Wundspreizer**  
**Self-Retaining Retractors**  
**Separadores con retenida automática**  
**Divaricatori autostatici**



**MOLLISON**  
 15,5 cm, 6"  
 75-2012-15



scharf  
 sharp  
 agudos  
 acuti



**SCHUHKNECHT**  
 12,5 cm, 5"



**75-2013-14**  
 scharf  
 sharp  
 agudos  
 acuti



**75-2014-14**  
 stumpf  
 blunt  
 romo  
 smusso



**WULLSTEIN**



scharf  
 sharp  
 agudos  
 acuti

stumpf  
 blunt  
 romo  
 smusso

10,5 cm, 4 <sup>1</sup> / <sub>8</sub> "	<b>75-2015-10</b>	<b>75-2016-10</b>
13,0 cm, 5"	<b>AK-2015-13</b>	<b>75-2016-13</b>
15,0 cm, 6"	<b>AK-2015-15</b>	<b>75-2016-15</b>
18,0 cm, 7"	<b>75-2015-18</b>	<b>75-2016-18</b>

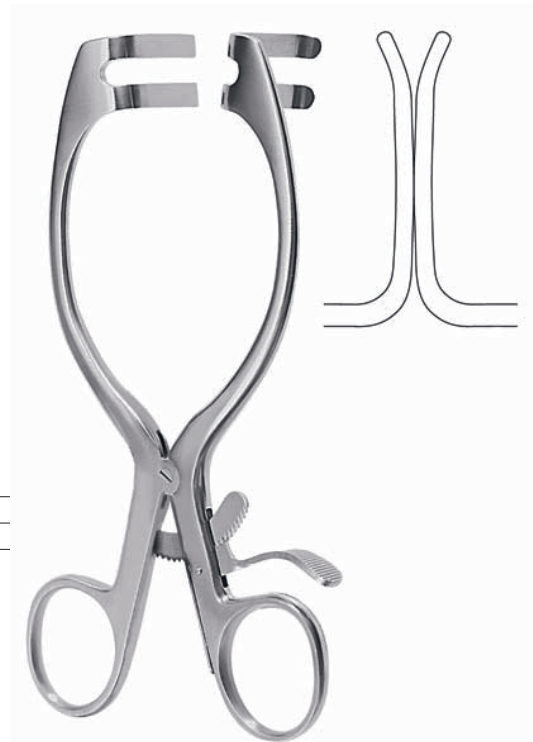

**MAYO-ADAMS**  
 16,5 cm, 6<sup>1</sup>/<sub>2</sub>"  
 75-2017-17

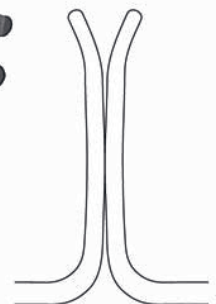

**Wundspreizer**  
**Self-Retaining Retractors**  
**Separadores con retenida automática**  
**Divaricatori autostatici**



**WEITLANER-LOKTITE**  
10,5 cm, 4<sup>1</sup>/<sub>8</sub>"



**AK-2018-10**

scharf  
sharp  
agudos  
acuti



**75-2019-10**

stumpf  
blunt  
romo  
smusso



**WEITLANER**  
13,0 cm, 5"



**AK-2020-13**

scharf  
sharp  
agudos  
acuti



**75-2021-13**

stumpf  
blunt  
romo  
smusso



**WEITLANER**  
16,5 cm, 6<sup>1</sup>/<sub>2</sub>"



**AK -2022-16**

scharf  
sharp  
agudos  
acuti



**75-2023-16**

stumpf  
blunt  
romo  
smusso



**WEITLANER**  
20,0 cm, 8"



**AK -2024-20**

scharf  
sharp  
agudos  
acuti



**75-2025-20**

stumpf  
blunt  
romo  
smusso

**Wundspreizer**  
**Self-Retaining Retractors**  
**Separadores con retenida automática**  
**Divaricatori autostatici**



**WEITLANER**  
 24,0 cm, 9½"



**AK-2026-20**   **75-2027-20**

scharf                      stumpf  
 sharp                      blunt  
 agudos                      romo  
 acuti                      smusso



**PLESTER**  
 13,0 cm, 5"

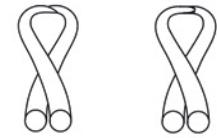

**AK-2028-13**   **AK-2029-13**

scharf                      stumpf  
 sharp                      blunt  
 agudos                      romo  
 acuti                      smusso



**MILLIGAN**  
 13,0 cm, 5"  
 75-2030-13

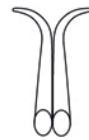
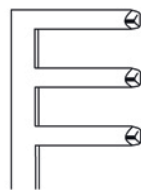
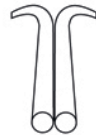

**PLESTER**  
 11,0 cm, 4¾"  
 75-2031-11

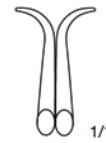

**PLESTER**  
 11,0 cm, 4¾"  
 75-2032-11



**WEITLANER-BABY**  
13,0 cm, 5"  
75-2035-13



**ADSON  
(CONE)**

**Wundspreizer**  
**Self-Retaining Retractors**  
**Separadores con retenida automática**  
**Divaricatori autostatici**

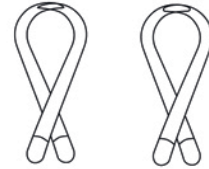

20,0 cm, 8" **75-2033-20** **75-2034-20**  
26,0 cm, 10 1/4" **AK-2033-26** **75-2034-26**

scharf	stumpf
sharp	blunt
agudos	romos
acuti	smusso



**GELPI**  
13,5 cm, 5 3/8"  
75-2036-14



**GELPI**  
19,0 cm, 7 1/2"  
75-2037-19



**GELPI-LOKTITE**  
19,0 cm, 7 1/2"  
75-2038-19

Wundspreizer  
Self-Retaining Retractors  
Separadores con retenida automática  
Divaricatori autostatici



**75-2042-32**

stumpf  
blunt  
romo  
smusso

**ADSON**  
32,0 cm, 12½"



10,0 cm, 4" **75-2043-10**  
14,0 cm, 5½" **75-2043-14**

**DE BAKEY**



Wundspreizer  
 Self-Retaining Retractors  
 Separadores con retenida automática  
 Divaricatori autostatici



**BECKMANN-ADSON**  
 31,0 cm, 12 1/4"

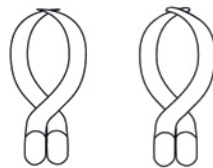

25 x 25 mm	<b>75-2039-01</b>	<b>75-2040-01</b>
25 x 31 mm	<b>75-2039-02</b>	<b>75-2040-02</b>
25 x 40 mm	<b>75-2039-03</b>	<b>75-2040-03</b>
25 x 45 mm	<b>75-2039-04</b>	<b>75-2040-04</b>

scharf	stumpf
sharp	blunt
agudos	romo
acuti	smusso

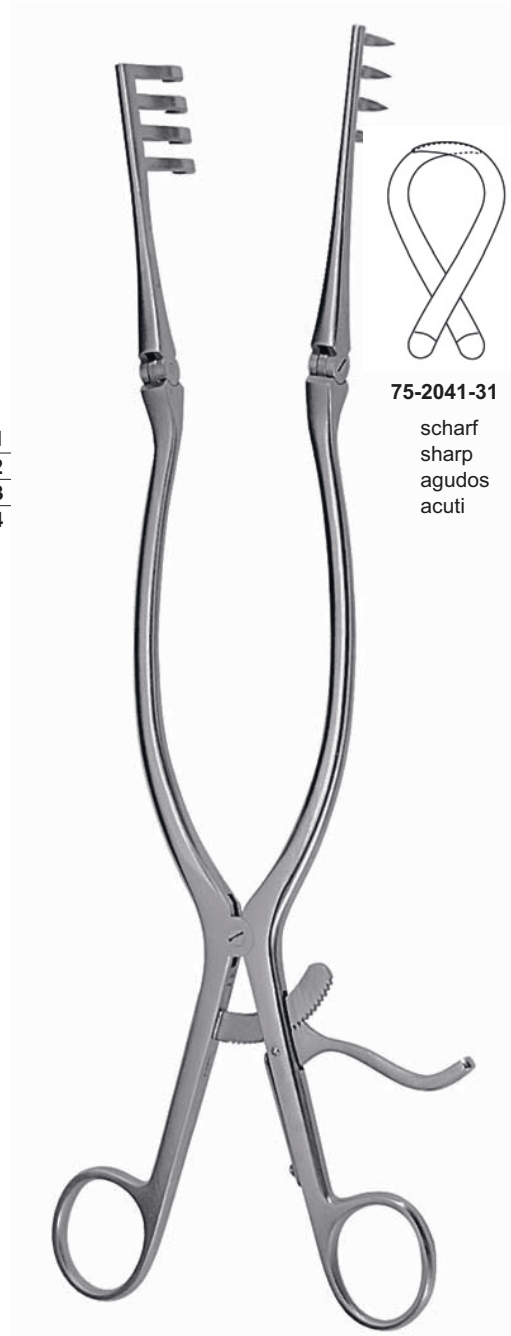

**BECKMANN**  
 31,0 cm, 12 1/4"



**75-2041-31**  
 scharf  
 sharp  
 agudos  
 acuti

**Wundspreizer**  
**Self-Retaining Retractors**  
**Separadores con retenida automática**  
**Divaricatori autostatici**

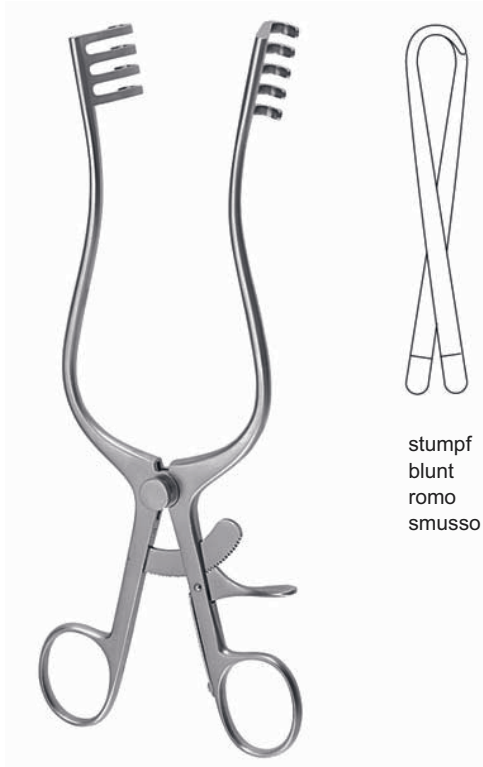

stumpf  
blunt  
romo  
smusso

**NORFOLK AND NORWICH**  
22,0 cm, 8<sup>5</sup>/<sub>8</sub>"  
75-2044-22

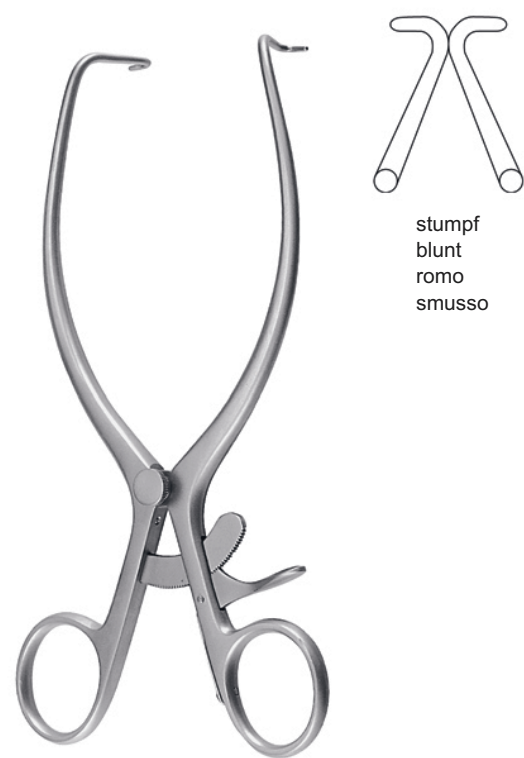

stumpf  
blunt  
romo  
smusso

**JACKSON BURROWS**  
17,5 cm, 7"  
75-2045-17



**RICHTER**  
17,0 cm, 6<sup>3</sup>/<sub>4</sub>"  
75-2046-17



**JOLL (FRIEDMAN)**  
15,5 cm, 6"  
75-2047-15

**Wundspreizer**  
**Self-Retaining Retractors**  
**Separadores con retenida automática**  
**Divaricatori autostatici**

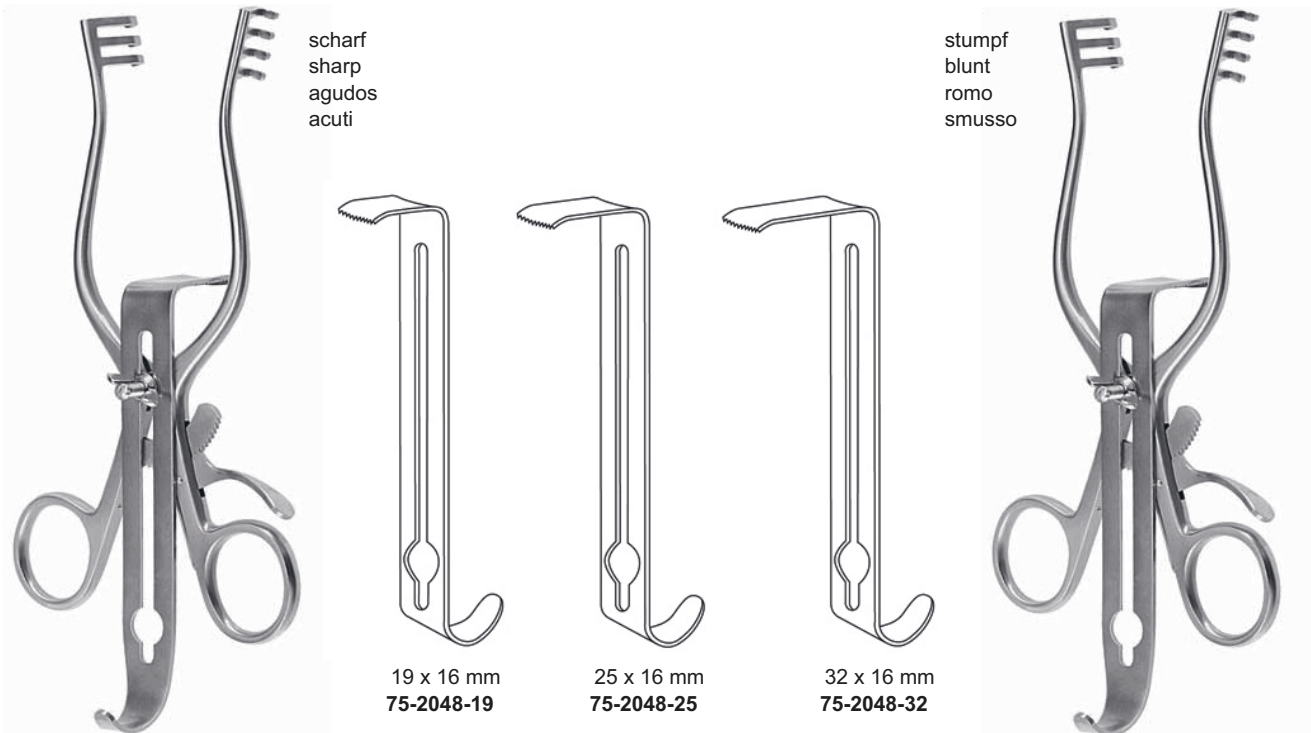

scharf  
sharp  
agudos  
acuti

stumpf  
blunt  
romo  
smusso

19 x 16 mm  
75-2048-19

25 x 16 mm  
75-2048-25

32 x 16 mm  
75-2048-32

**HENLEY**  
16,0 cm, 6 1/4"  
75-2048-16

**HENLEY**  
16,0 cm, 6 1/4"  
75-2049-16

**HENLEY**  
**75-2050-00**

komplett, bestehend aus:

- 1 Sperrer mit Seitenvalven, scharf (75-300-16)
- 1 Mittelvalve 19 x 16 mm (75-300-19)
- 1 Mittelvalve 25 x 16 mm (75-300-25)
- 1 Mittelvalve 32 x 16 mm (75-300-32)

complete, consisting of:

- 1 Spreader with lateral valves, sharp (75-300-16)
- 1 Central valve 19 x 16 mm (75-300-19)
- 1 Central valve 25 x 16 mm (75-300-25)
- 1 Central valve 32 x 16 mm (75-300-32)

completo, compuesto of:

- 1 Separador con valvas laterales, agudas (070-300-16)
- 1 Valva central 19 x 16 mm (75-300-19)
- 1 Valva central 25 x 16 mm (75-300-25)
- 1 Valva central 32 x 16 mm (75-300-32)

completo, composto da:

- 1 Divaricatore con valve laterali, acuto (75-300-16)
- 1 Valva centrale 19 x 16 mm (75-300-19)
- 1 Valva centrale 25 x 16 mm (75-300-25)
- 1 Valva centrale 32 x 16 mm (75-300-32)

**HENLEY**  
**75-2051-00**

komplett, bestehend aus:

- 1 Sperrer mit Seitenvalven, stumpf (75-301-16)
- 1 Mittelvalve 19 x 16 mm (75-300-19)
- 1 Mittelvalve 25 x 16 mm (75-300-25)
- 1 Mittelvalve 32 x 16 mm (75-300-32)

complete, consisting of:

- 1 Spreader with lateral valves, blunt (75-301-16)
- 1 Central valve 19 x 16 mm (75-300-19)
- 1 Central valve 25 x 16 mm (75-300-25)
- 1 Central valve 32 x 16 mm (75-300-32)

completo, compuesto of:

- 1 Separador con valvas laterales, romas (75-301-16)
- 1 Valva central 19 x 16 mm (75-300-19)
- 1 Valva central 25 x 16 mm (75-300-25)
- 1 Valva central 32 x 16 mm (75-300-32)

completo, composto da:

- 1 Divaricatore con valve laterali, smusso (75-301-16)
- 1 Valva centrale 19 x 16 mm (75-300-19)
- 1 Valva centrale 25 x 16 mm (75-300-25)
- 1 Valva centrale 32 x 16 mm (75-300-32)

**Wundspreizer, Bauchdeckenhalter**  
**Self-Retaining Retractors, Abdominal Retractors**  
**Separadores con retenida automática, Separadores abdominales**  
**Divaricatori autostatici, Divaricatori addominali**



**COLLIN**  
23,5 cm, 9<sup>1</sup>/<sub>4</sub>"  
75-2058-24



**COLLIN**  
23,5 cm, 9<sup>1</sup>/<sub>4</sub>"  
75-2059-24



**COLLIN**  
23,5 cm, 9<sup>1</sup>/<sub>4</sub>"  
75-2060-24

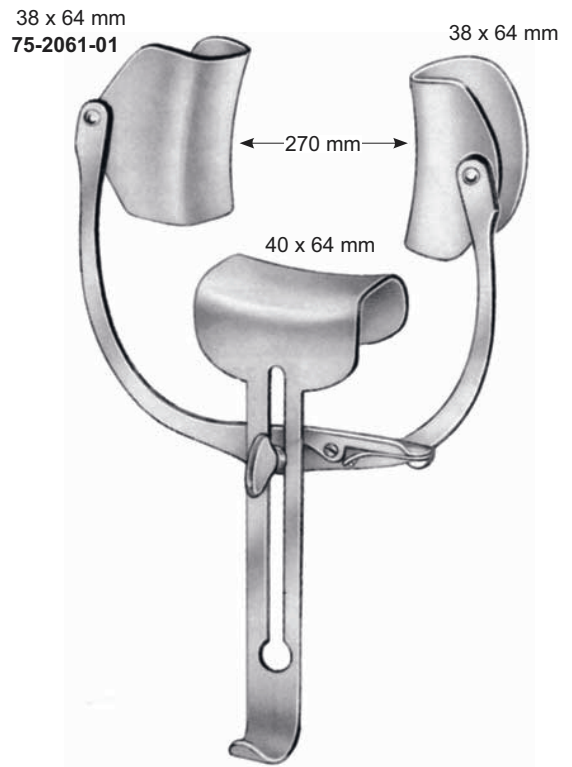

**ROBIN-MASSE**  
23,5 cm, 9<sup>1</sup>/<sub>4</sub>"  
75-2061-27

Wundspreizer, Bauchdeckenhalter  
 Self-Retaining Retractors, Abdominal Retractors  
 Separadores con retenida automática, Separadores abdominales  
 Divaricatori autostatici, Divaricatori addominali



**MAYO-ADAMS**  
 17,0 cm, 6<sup>3</sup>/<sub>4</sub>"  
 75-2054-17



**COLLIN-BABY**  
 18,0 cm, 7"  
 75-2055-18

30 x 44 mm  
 75-2052-30



23 x 44 mm  
 75-2053-23

Wechselvalven  
 Exchangeable blades  
 Valvas intergambiabiles  
 Valve intercambiabili

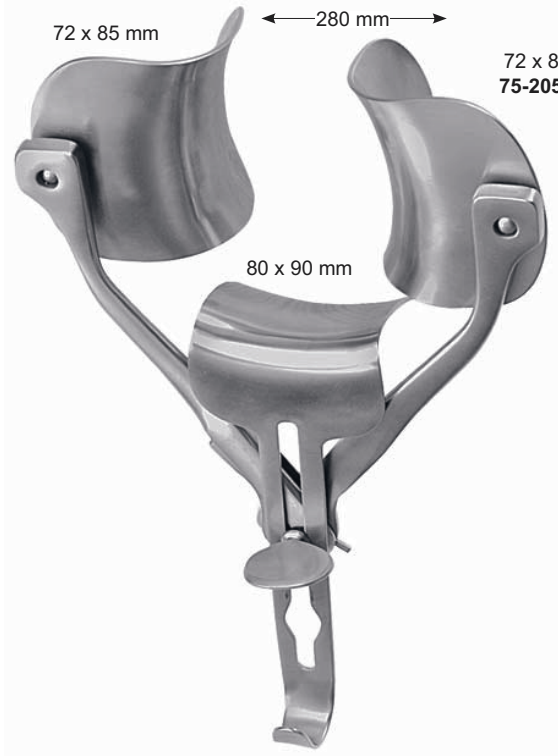

**RICARD**  
 28,0 cm, 11"  
 75-2056-28



**RICARD**  
 30,0 cm, 12"  
 75-2057-30

Bauchdeckenhalter  
Abdominal Retractors  
Separadores abdominales  
Divaricatori addominali



**GOSSET**  
75-2071-10



**GOSSET**  
75-2072-14



**GOSSET**  
75-2073-16



**ABADIE**  
75-2074-12

Wundspreizer, Bauchdeckenhalter  
Self-Retaining Retractors, Abdominal Retractors  
Separadores con retenida automática, Separadores abdominales  
Divaricatori autostatici, Divaricatori addominali

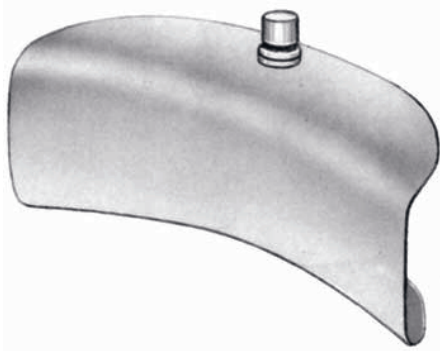

38 x 62 mm **75-2062-01**  
40 x 80 mm **75-2062-02**  
60 x 80 mm **75-2062-03**

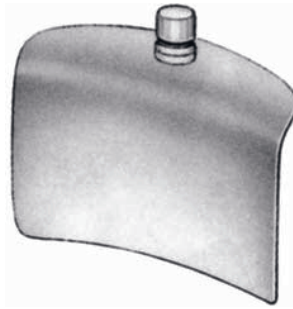

50 x 58 mm **75-2063-10**  
60 x 80 mm **75-2063-13**  
72 x 85 mm **75-2063-14**

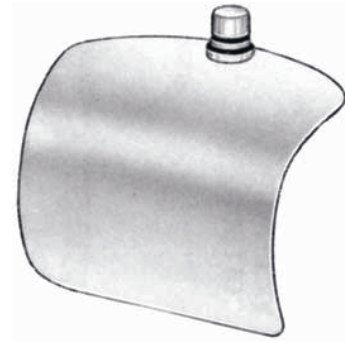

**75-2064-23**  
60 x 80 mm

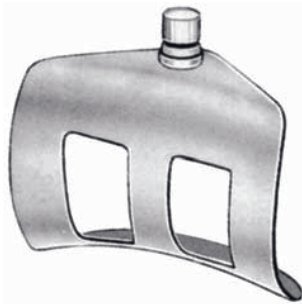

**75-2064-33**  
60 x 80 mm



58 x 50 mm **75-2065-01**  
80 x 60 mm **75-2065-02**  
85 x 72 mm **75-2065-03**



62 x 38 mm **75-2066-10**  
80 x 38 mm **75-2066-11**  
100 x 38 mm **75-2066-12**  
80 x 38 mm **75-2066-13**



**COLLIN**  
55 x 55 mm **75-2068-01**  
55 x 65 mm **75-2068-02**  
55 x 75 mm **75-2068-03**



**ROBIN-MASSE**  
40 x 64 mm **75-2069-01**  
55 x 65 mm **75-2069-02**  
55 x 75 mm **75-2069-03**



**RICARD**  
65 x 50 mm **75-2070-01**  
70 x 55 mm **75-2070-02**  
90 x 80 mm **75-2070-03**

Bauchdeckenhalter  
Abdominal Retractors  
Separadores abdominales  
Divaricatori addominali



**BALFOUR**  
100 x 70 mm  
75-2079-70

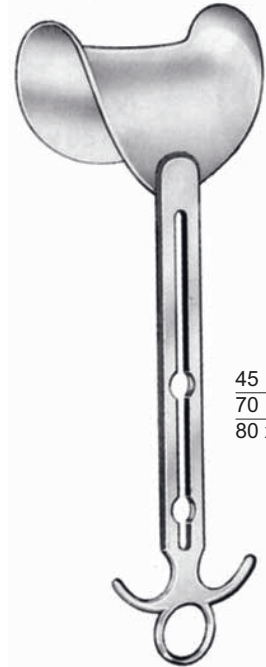

**BALFOUR**

45 x 80 mm **75-2079-01**  
70 x 85 mm **75-2079-02**  
80 x 90 mm **75-2079-03**

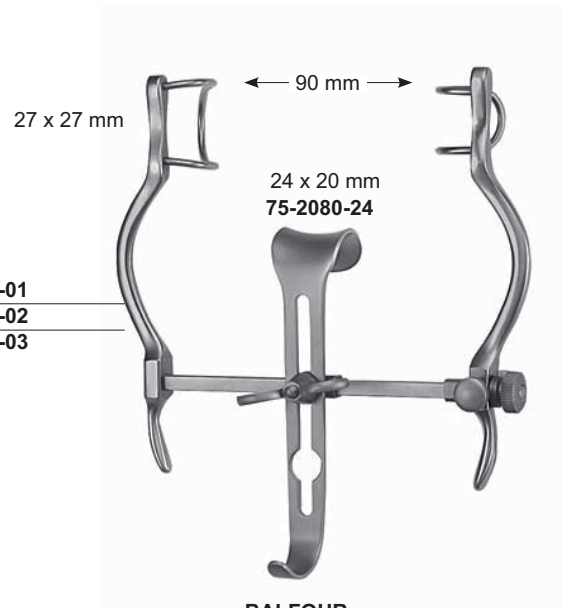

**BALFOUR**  
75-2080-09



**BERKELEY**  
75-2081-00

35 x 60 mm  
75-2081-01

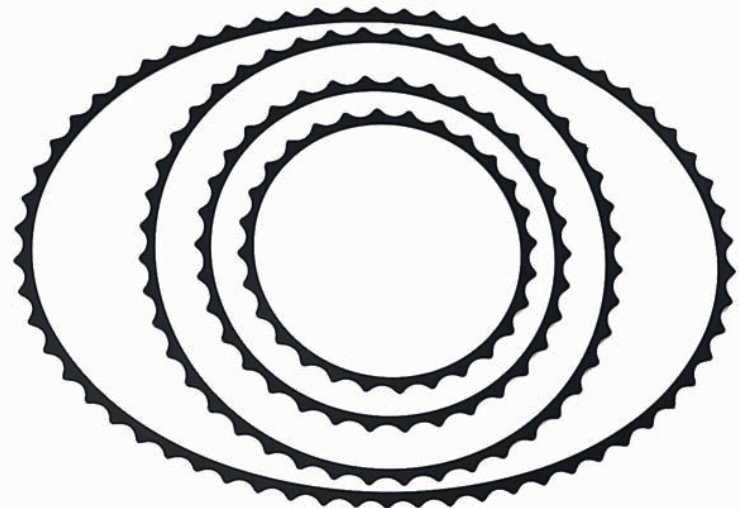

**TURNER-WARNICK**  
modifiziert

Ø 180 mm, 7" **75-2081-18**  
Ø 230 mm, 9" **75-2081-23**  
Ø 305 mm, 12" **75-2081-30**  
455 x 330 mm **75-2081-45**



**Bauchdeckenhalter**  
**Abdominal Retractors**  
**Separadores abdominales**  
**Divaricatori addominali**

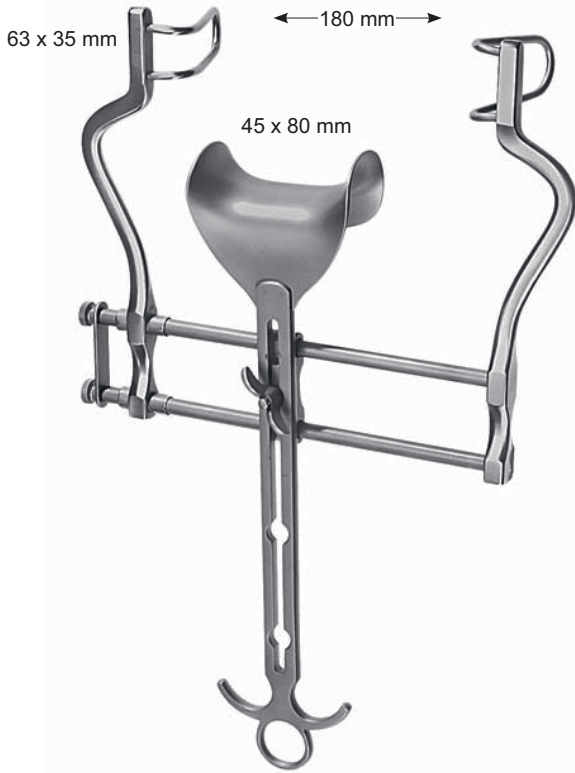

**BALFOUR**  
75-2075-18



**BALFOUR**  
75-2076-20



**BALFOUR**  
75-2077-25

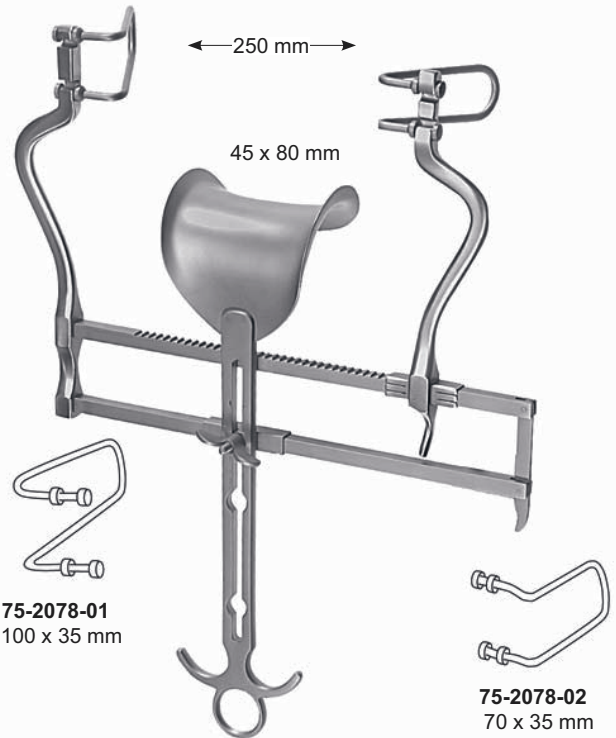

**BALFOUR US-TYPE**  
75-2078-25

Bauchdeckenhalter  
Abdominal Retractors  
Separadores abdominales  
Divaricatori addominali

geschwärzt, black fi nish, negra, nera



**AK-2082-01**  
13 mm



**75-2082-02**  
51 x 38 mm



**75-2082-03**  
70 x 60 mm



**75-2082-04**  
89 x 60 mm



**75-2082-05**  
114 x 60 mm

## TURNER-WARNICK modifiziert

geschwärzt, black fi nish, negra, nera



**75-2083-06**  
19 x 76 mm



**75-2083-07**  
38 x 102 mm



**75-2083-08**  
57 x 89 mm



**75-2083-09**  
57 x 114 mm

**Bauchdeckenhalter**  
**Abdominal Retractors**  
**Separadores abdominales**  
**Divaricatori addominali**

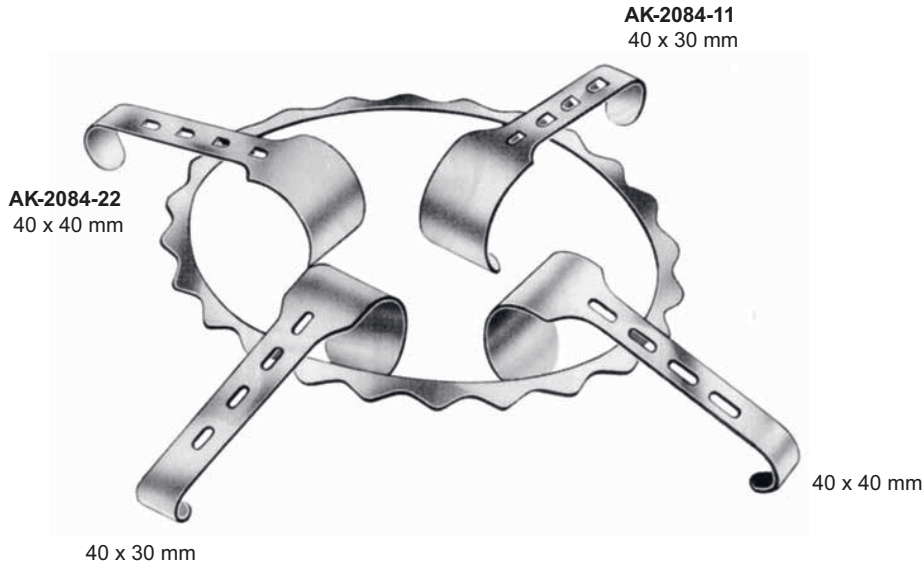

**75-2084-01**  
**255 x 180 mm**  
Rahmen allein  
frame only  
cuadro suelto  
solo telaio

**DENNIS BROWN**  
**255 x 180 mm**  
**75-2084-00**  
komplett complete  
completo  
completo

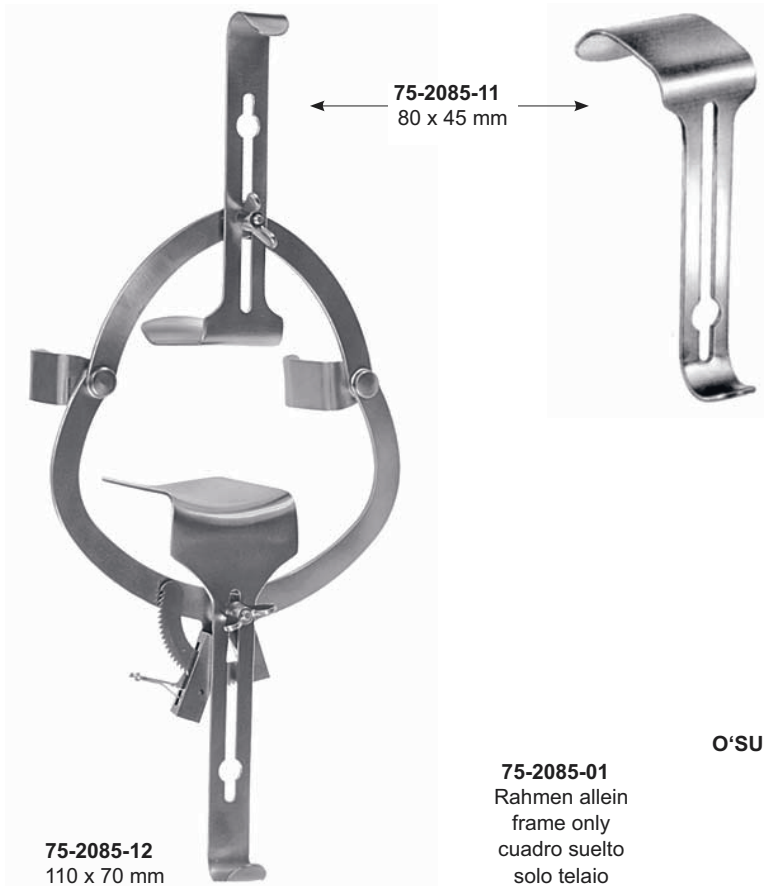

**Bauchdeckenhalter**  
**Abdominal Retractors**  
**Separadores abdominales**  
**Divaricatori addominali**

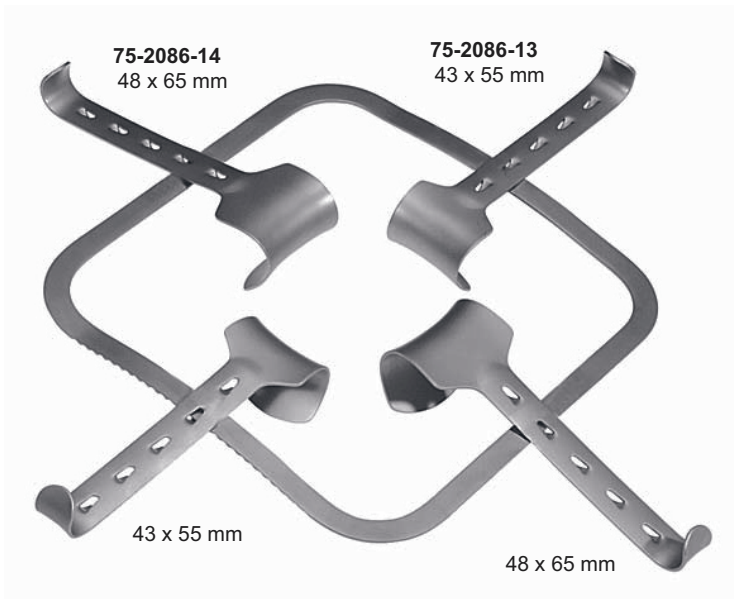

**75-2086-01** 250 x 250 mm  
**75-2087-01** 300 x 320 mm  
**75-2088-01** 300 x 380 mm  
Rahmen allein  
frame only  
cuadro suelto  
solo telaio

**KIRSCHNER**  
**75-2089-00**  
komplett  
complete  
completo  
completo  
1 x 074-880-01  
2 x 074-880-13  
2 x 074-880-14



**75-2090-01**  
255 x 255 mm  
zusammenlegbarer Rahmen, allein  
folding frame, only  
cuadro plegable, suelto  
telaio pieghevole, solo

**KIRSCHNER**  
**75-2090-00**  
komplett  
complete  
completo  
completo  
1 x 074-882-01  
2 x 074-880-13  
2 x 074-880-14



43 x 55 mm	<b>75-2091-13</b>
48 x 65 mm	<b>75-2091-14</b>
80 x 90 mm	<b>75-2091-15</b>
90 x 65 mm	<b>75-2091-16</b>
98 x 95 mm	<b>75-2091-17</b>

**KIRSCHNER**

Bauchdeckenhalter  
Abdominal Retractors  
Separadores abdominales  
Divaricatori addominali



**KIRSCHNER**  
60 x 82 mm  
75-2092-11



**KIRSCHNER-BALFOUR**  
83 x 82 mm  
75-2092-12



**KIRSCHNER**  
98 x 51 mm **75-2092-20**  
105 x 38 mm **75-2092-21**

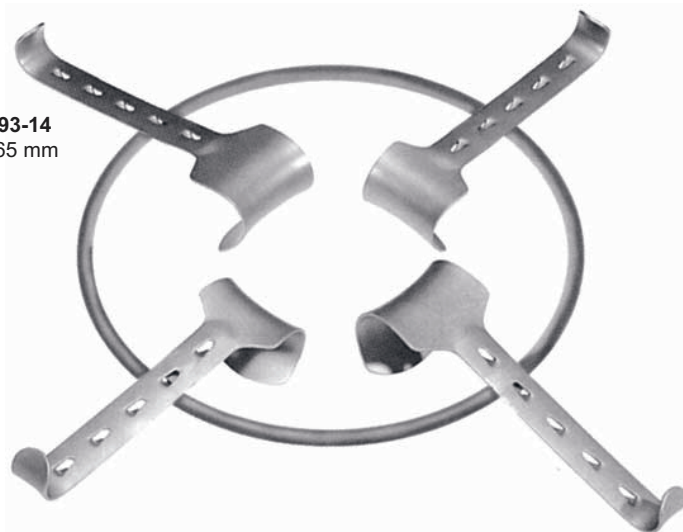

**75-2093-14**  
48 x 65 mm

**75-2094-01**  
300 x 240 mm  
Rahmen allein  
frame only  
cuadro suelto  
solo telaio





**75-2095-15**  
80 x 90 mm

**KIRSCHNER, oval**  
**75-2096-00**  
komplett, complete, completo, completo  
1 x 074-884-01  
3 x 074-880-14  
1 x 074-880-15  
1 x 074-880-20  
1 x 074-880-21

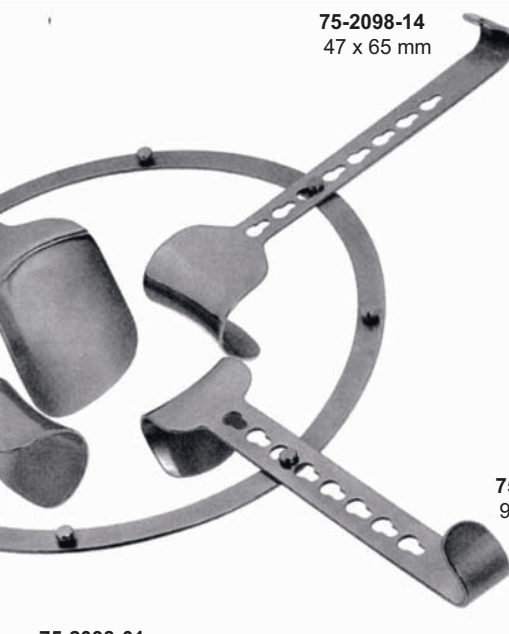

**KIRSCHNER**  
98 x 51 mm **75-2097-20**  
105 x 38 mm **75-2097-21**

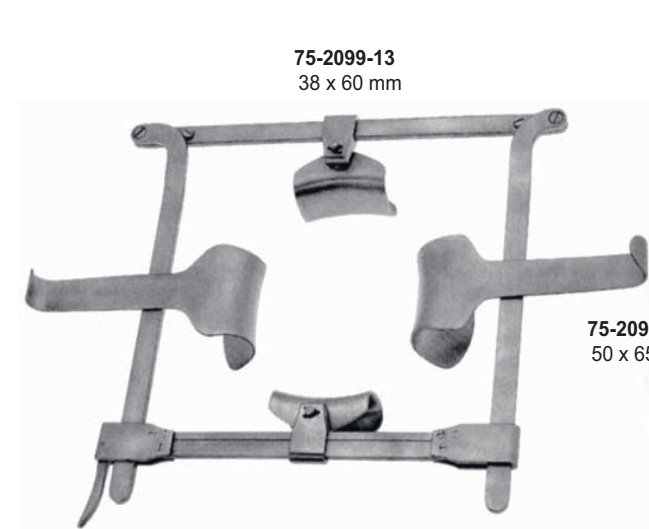
**Bauchdeckenhalter**  
**Abdominal Retractors**  
**Separadores abdominales**  
**Divaricatori addominali**

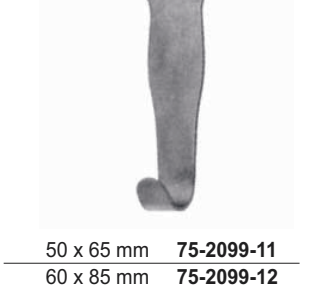
 <p><b>75-2098-13</b> 76 x 98 mm</p>	 <p><b>75-2098-14</b> 47 x 65 mm</p>	 <p><b>75-2098-11</b> 98 x 52 mm</p> <p><b>75-2098-12</b> 105 x 35 mm</p>
<p>47 x 65 mm</p>	<p><b>75-2098-01</b> 275 x 250 mm Rahmen allein frame only cuadro suelto solo telaio</p>	<p><b>75-2098-15</b> 50 x 54 mm</p>
 <p><b>75-2099-13</b> 38 x 60 mm</p>	 <p><b>75-2099-11</b> 50 x 65 mm</p> <p><b>75-2099-01</b> 300 x 300 mm zusammenlegbarer Rahmen, allein folding frame, only cuadro plegable, suelto telaio pieghevole, solo</p>	
<p><b>FRANZ</b>  <b>75-2099-00</b>          komplett          complete          completo          completo          1 x 031-1900-01          2 x 031-1900-11          2 x 031-1900-13</p>	 <p>38 x 60 mm <b>75-2099-13</b>          45 x 80 mm <b>75-2099-14</b></p>	 <p>50 x 65 mm <b>75-2099-11</b>          60 x 85 mm <b>75-2099-12</b></p>

**Bauchdeckenhalter**  
**Abdominal Retractors**  
**Separadores abdominales**  
**Divaricatori addominali**

für / for / para / per  
031-2100-11  
031-2100-14



95 x 60 mm **75-2100-11**  
105 x 65 mm **75-2100-12**  
115 x 65 mm **75-2100-13**  
125 x 65 mm **75-2100-14**

**DOYEN**  
28,0 cm, 11"



Kette mit Gewicht  
Chain with weight  
Cadena con pesa  
Catena con peso

**75-2102-30**  
78,5 cm, 31"



53,0 cm, 21"

66,0 cm, 26"

Befestigungsgestell  
Mounting frame  
Bastidor para la fijación  
Telaio di supporto per il fissaggio

**ROCHARD**  
**75-2103-01**



53,0 cm, 21"

66,0 cm, 26"

Befestigungsgestell  
Mounting frame  
Bastidor para la fijación  
Telaio di supporto per il fissaggio

**ROCHARD**  
**75-2104-02**



**ROCHARD**  
28,0 cm, 11"  
**75-2104-20**

95 x 48 mm **75-2104-10**  
105 x 48 mm **75-2104-12**  
115 x 48 mm **75-2104-12**  
125 x 48 mm **75-2104-13**  
155 x 48 mm **75-2104-16**

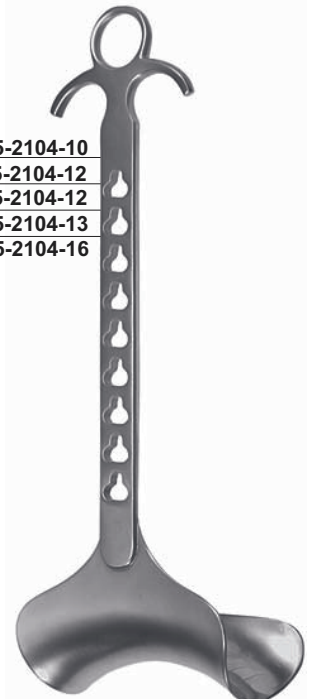

**ROCHARD**  
28,0 cm, 11"

Bauchspatel  
Abdominal Spatulas  
Espátulas abdominales  
Spatole addominali



biegsam  
malleable  
maleable  
malleabile

200 x 6 mm	<b>75-2105-06</b>
200 x 12 mm	<b>75-2105-12</b>
200 x 17 mm	<b>75-2105-17</b>
200 x 20 mm	<b>75-2105-20</b>
200 x 25 mm	<b>75-2105-25</b>



biegsam  
malleable  
maleable  
malleabile

330 x 13 mm	<b>75-2106-13</b>
330 x 25 mm	<b>75-2106-25</b>
330 x 32 mm	<b>75-2106-32</b>
330 x 40 mm	<b>75-2106-40</b>
330 x 50 mm	<b>75-2106-50</b>

**RIBBON**



biegsam  
malleable  
maleable  
malleabile

280 x 25/30 mm	<b>75-2107-01</b>
300 x 37/45 mm	<b>75-2107-02</b>
300 x 40/50 mm	<b>75-2107-03</b>

**RIBBON**

**RIBBON**



biegsam  
malleable  
maleable  
malleabile

**TUFFIER**  
200 x 25/17 mm  
**75-2108-20**



**REVERDIN**  
280 x 45/60 mm  
**75-2109-28**



Rippensperrer  
Rib Spreaders  
Separadores costales  
Divaricatori costali

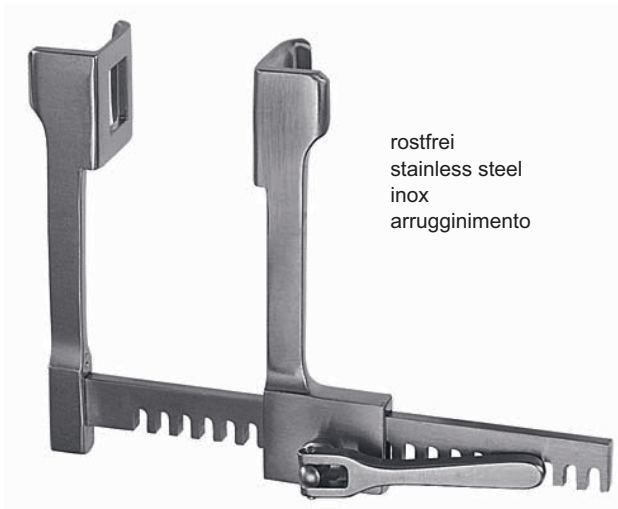

rostfrei  
stainless steel  
inox  
arrugginimento

**FINOCCHIETTO-BABY**

a	b	c	
18 mm	20 mm	75 mm	<b>75-2110-01</b>

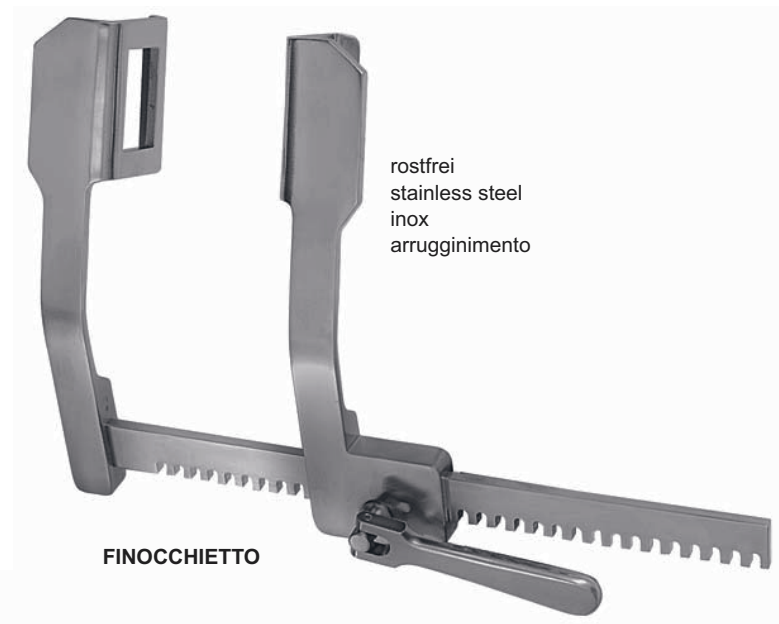

rostfrei  
stainless steel  
inox  
arrugginimento

**FINOCCHIETTO**

a	b	c	
40 mm	40 mm	165 mm	<b>75-2110-02</b>
45 mm	65 mm	200 mm	<b>75-2110-03</b>
70 mm	65 mm	250 mm	<b>75-2110-04</b>



rostfrei  
stainless steel  
inox  
arrugginimento

**TUFFIER**

a	b	c	
50 mm	45 mm	165 mm	<b>75-2111-01</b>

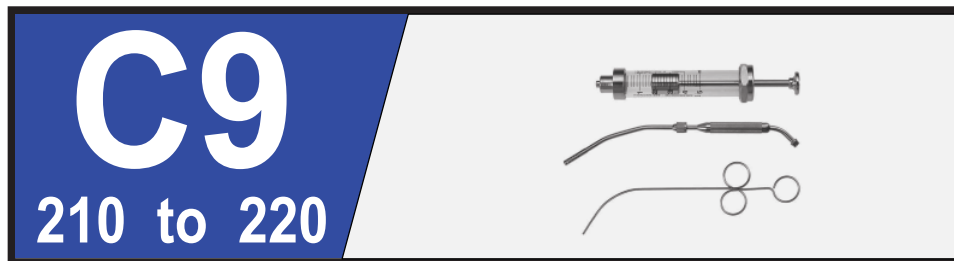

**Sonden, Trokare**

**Probes, Trocars**

**Sondas, Trócares**

**Sonde, Trequacti**

Sonden  
Probes  
Sondas  
Sonde



	Ø 1,0 mm	Ø 2,0 mm
11,5 cm, 4 1/2"	<b>75-2112-11</b>	<b>75-2113-11</b>
13,0 cm, 5"	<b>75-2112-13</b>	<b>75-2113-13</b>
14,5 cm, 5 3/4"	<b>75-2112-14</b>	<b>75-2113-14</b>
16,0 cm, 6 1/4"	<b>75-2112-16</b>	<b>75-2113-15</b>
18,0 cm, 7"	<b>75-2112-18</b>	<b>75-2113-18</b>
20,0 cm, 8"	<b>75-2112-20</b>	<b>75-2113-20</b>

Ø 2,0 mm



11,5 cm, 4 1/2"	<b>75-2115-11</b>
13,0 cm, 5"	<b>75-2115-13</b>
14,5 cm, 5 3/4"	<b>75-2115-14</b>
16,0 cm, 6 1/4"	<b>75-2115-16</b>
18,0 cm, 7"	<b>75-2115-18</b>
20,0 cm, 8"	<b>75-2115-20</b>

Ø 1,0 mm



Silber  
Silver  
Plata  
Argento

**STACKE**  
10,5 cm, 4 1/8"  
**75-1033-10**



Myrtenblattsonden  
Myrtle leaf probes  
Sondas para mirto  
Sonde a foglia di mirto

11,5 cm, 4 1/2"	<b>75-2116-11</b>
13,0 cm, 5"	<b>75-2116-13</b>
14,5 cm, 5 3/4"	<b>75-2116-14</b>
16,0 cm, 6 1/4"	<b>75-2116-16</b>
18,0 cm, 7"	<b>75-2116-18</b>
20,0 cm, 8"	<b>75-2116-20</b>

Ø 3,5 mm



**NÉLATON**  
16,0 cm, 6 1/4"  
**75-2117-16**



**DOYEN**  
14,5 cm, 5 3/4"  
**75-2118-14**



**BRODIE**  
20,0 cm, 8"  
**75-2119-20**

Sonden  
Probes  
Sondas  
Sonde

Ø 3,5 mm



11,5 cm, 4 1/2"	<b>75-2120-11</b>
13,0 cm, 5"	<b>75-2120-13</b>
14,5 cm, 5 3/4"	<b>75-2120-14</b>
16,0 cm, 6 1/4"	<b>75-2120-16</b>
18,0 cm, 7"	<b>75-2120-18</b>
20,0 cm, 8"	<b>75-2120-20</b>

Ø 3,3 mm



13,0 cm, 5"	<b>75-2121-13</b>
14,5 cm, 5 3/4"	<b>75-2121-14</b>
16,0 cm, 6 1/4"	<b>75-2121-16</b>
18,0 cm, 7"	<b>75-2121-18</b>



**LOCKHA75-MUMMERY**  
16,5 cm, 6 1/2"  
**75-2122-01**



**LOCKHA75-MUMMERY**  
16,5 cm, 6 1/2"  
**75-2122-02**



**LOCKHA75-MUMMERY**  
16,5 cm, 6 1/2"  
**75-2122-03**



**LOCKHA75-MUMMERY**  
16,5 cm, 6 1/2"  
**75-2122-04**

Watteträger  
Cotton Applicators  
Porta-algodones  
Porta-cotone



**FEIN**  
28,0 cm, 11"  
75-2123-28



**UKERMANN**  
16,0 cm, 6 1/4"  
75-2124-16



**JOBSON-HORNE**  
18,0 cm, 7"  
75-2125-18



12,0 cm, 4 3/4"	<b>75-2126-12</b>	Ø 0,9 mm
14,0 cm, 5 3/4"	<b>75-2126-14</b>	Ø 0,9 mm
16,5 cm, 6 1/4"	<b>75-2126-16</b>	Ø 1,1 mm
18,0 cm, 7"	<b>75-2126-18</b>	Ø 1,2 mm

**FARRELL**  
(LATHBURY)



12,0 cm, 4 "	<b>75-2127-12</b>	Ø 0,9 mm
14,0 cm, 5 3/4"	<b>75-2127-14</b>	Ø 0,9 mm
16,5 cm, 6 3/4"	<b>75-2127-16</b>	Ø 1,1 mm
18,0 cm, 7 1/4"	<b>75-2127-18</b>	Ø 1,2 mm

**FARRELL**

**Krampfader-Besteck**  
**Varicose Vein Probe Set**  
**Juego para várices**  
**Astuccio per varici**



**NABATOFF**  
**75-2128-00**  
komplett  
complete  
completo  
completo

**75-2128-01**  
Metalletui  
Metal case  
Estuche de metal  
Scatola in metallo

135 x 100 x 25 mm



Ø 3,0 mm  
**75-2128-03**



Ø 6,0 mm  
**75-2128-06**



Ø 9,0 mm  
**75-2128-09**



Ø 12,0 mm  
**75-2128-12**



**75-2128-21**  
Zugseil  
Cable  
Cable  
Fune

**75-2128-22**  
Kunststoff-Sondenspitze  
Plastic probe tip  
Extremidad de sonda de plástico  
Punta in materia plastica

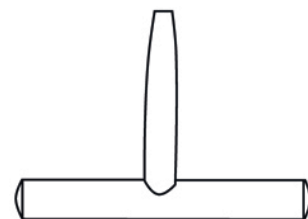

**75-2128-20**  
Handgriff  
Handle  
Mango  
Manico

Trokare  
Trocars  
Trócares  
Trequarti



Ø 3,0 mm	<b>75-2129-30</b>
Ø 3,5 mm	<b>75-2129-35</b>
Ø 4,0 mm	<b>75-2129-40</b>
Ø 4,5 mm	<b>75-2129-45</b>
Ø 5,0 mm	<b>75-2129-50</b>
Ø 5,5 mm	<b>75-2129-55</b>
Ø 6,0 mm	<b>75-2129-60</b>

**STANDARD**  
11,0 cm, 4<sup>3</sup>/<sub>8</sub>"



Ø 3,0 mm	<b>75-2130-30</b>
Ø 3,5 mm	<b>75-2130-35</b>
Ø 4,0 mm	<b>75-2130-40</b>
Ø 4,5 mm	<b>75-2130-45</b>
Ø 5,0 mm	<b>75-2130-50</b>
Ø 5,5 mm	<b>75-2130-55</b>
Ø 6,0 mm	<b>75-2130-60</b>

**STANDARD**  
12,0 cm, 4<sup>3</sup>/<sub>4</sub>"



Ø 3,0 mm	<b>75-2131-30</b>
Ø 3,5 mm	<b>75-2131-35</b>
Ø 4,0 mm	<b>75-2131-40</b>
Ø 4,5 mm	<b>75-2131-45</b>
Ø 5,0 mm	<b>75-2131-50</b>
Ø 5,5 mm	<b>75-2131-55</b>
Ø 6,0 mm	<b>75-2131-60</b>

**STANDARD**  
12,0 cm, 4<sup>3</sup>/<sub>4</sub>"



Ø 7,3 mm	<b>75-2132-07</b>
Ø 8,7 mm	<b>75-2132-09</b>
Ø 12,0 mm	<b>75-2132-12</b>

**HURWITZ**



**UNIVERSAL**  
75-2132-03

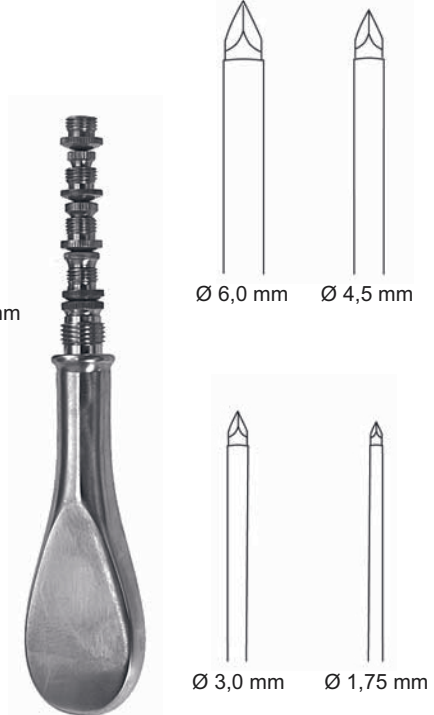

**UNIVERSAL**  
75-2132-04

Trokare  
Trocars  
Trócares  
Trequarti

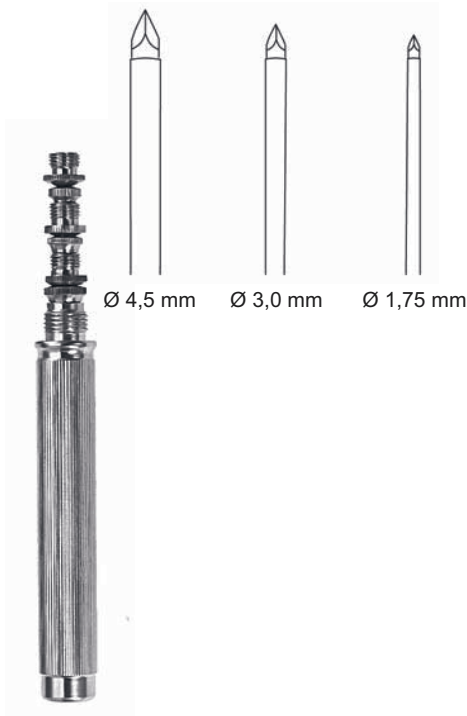

**UNIVERSAL**  
75-2133-03



**UNIVERSAL**  
75-2133-04

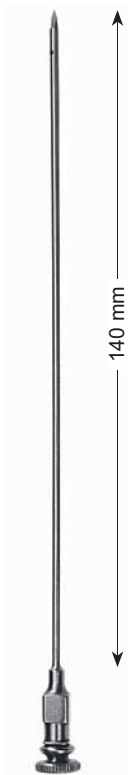

**LANDAU**  
Ø 2,0 mm  
75-2134-16



**LANDAU**  
Ø 2,0 mm  
75-2135-16



**DAVIDSON**  
Ø 6,0 mm  
75-2136-18



**BUELAU**  
Ø 8,0 mm  
75-2137-24



Trokare  
Trocars  
Trócares  
Treuarti



Ø 2,0 mm	<b>75-2138-20</b>
Ø 2,5 mm	<b>75-2138-25</b>
Ø 3,0 mm	<b>75-2138-30</b>

**LERMOYEZ**



Ø 6,0 mm	<b>75-2139-06</b>
Ø 8,0 mm	<b>75-2139-08</b>

**CAMPBELL**  
16,0 cm, 6 1/4"

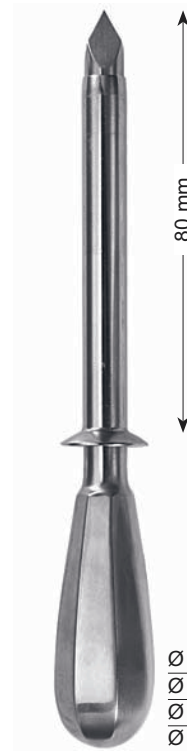

80 mm

Ø 7,5 mm	<b>75-2140-01</b>
Ø 9,0 mm	<b>75-2140-02</b>
Ø 10,5 mm	<b>75-2140-03</b>
Ø 12,0 mm	<b>75-2140-04</b>

**NELSON**  
21,0 cm, 8 1/2"

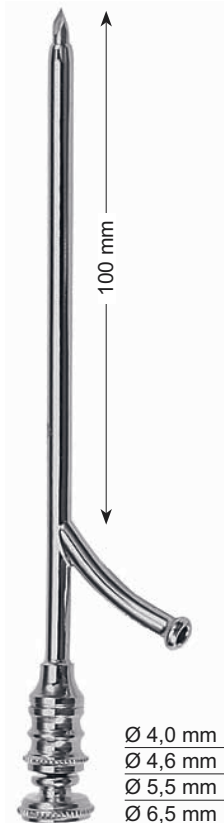

100 mm

Ø 4,0 mm	<b>75-2141-01</b>
Ø 4,6 mm	<b>75-2141-02</b>
Ø 5,5 mm	<b>75-2141-03</b>
Ø 6,5 mm	<b>75-2141-04</b>

**OCHSNER**  
14,0 cm, 5 1/2"



Record Konus  
Record cone

Ø 3,0 mm	<b>75-2142-30</b>
Ø 4,0 mm	<b>75-2142-40</b>
Ø 5,0 mm	<b>75-2142-50</b>

**PIERCE**  
16,0 cm, 6 1/4"



Ø 2,25 mm

**COAKLEY**  
14,0 cm, 5 1/4"  
**75-2143-14**



Ø 4,0 mm

**KRAUSE**  
16,0 cm, 6¼"

**LICHTWITZ**  
Kieferhöhlentrokare  
Antrum trocars  
Trócares para el seno maxilar  
Trequarti per puntura del seno mascellare

Ø 1,8 mm

Ø 3,0 mm **75-2144-30**  
Ø 4,0 mm **75-2144-40**  
Ø 5,0 mm **75-2144-50**  
Ø 5,5 mm **75-2144-55**



**LICHTWITZ**  
20,0 cm, 8"  
**75-2145-00**

**Trokare, Saugrohre**  
**Trocars, Suction Tubes**  
**Trócares, Tubos para aspiración**  
**Trequarti, Tubi aspirazione**

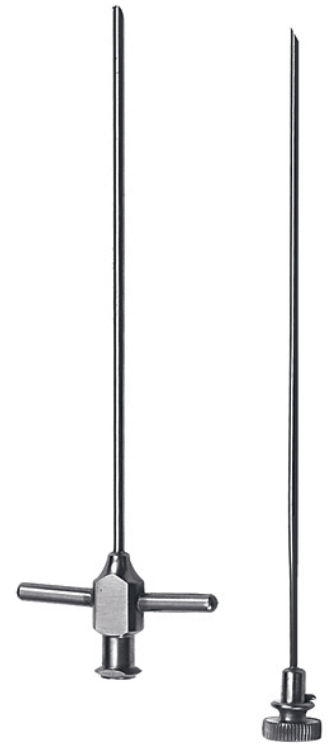

**LICHTWITZ**  
11,0 cm, 4½"  
**75-2145-00**



**DOUGLAS**  
Ø 3,0 mm  
**75-2146-00**



**POOLE**  
22,0 cm, 8⅝"

Ø 6,0 mm **75-2147-06**  
Ø 10,0 mm **75-2147-10**



**POOLE**  
22,0 cm, 8⅝"

Ø 6,0 mm **75-2148-06**  
Ø 8,0 mm **75-2148-08**

**Saugrohre**  
**Suction Tubes**  
**Tubos para aspiración**  
**Tubi aspirazione**

auswechselbare Spitze  
interchangeable tip  
punta intercambiables  
tipo intercambiabile



Ø 3,5 mm  
75-2149-35



**75-2150-00**  
Olive allein  
Olive only  
Oliva suelto  
Olivo solo



**COUPLAND**  
17,0 cm, 6<sup>3</sup>/<sub>4</sub>"  
75-2149-17



**YANKAUER**  
27,0 cm, 10<sup>5</sup>/<sub>8</sub>"  
75-1000-27

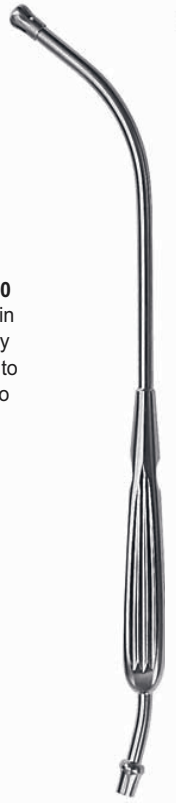

**DE BAKEY**  
27,0 cm, 10<sup>5</sup>/<sub>8</sub>"  
75-2151-27



**ANTHONY**  
26,0 cm, 10<sup>1</sup>/<sub>4</sub>"  
75-2151-26



**ANDREWS-PYNCHON**  
24,0 cm, 9<sup>1</sup>/<sub>2</sub>"  
75-2151-24



**COOLEY**  
35,0 cm, 13<sup>3</sup>/<sub>4</sub>"  
Ø 8,0 mm  
75-2152-02



**COOLEY**  
30,0 cm, 11<sup>3</sup>/<sub>4</sub>"  
Ø 7,0 mm  
75-2153-03



**COOLEY**  
31,0 cm, 11<sup>3</sup>/<sub>4</sub>"  
Ø 10,0 mm  
75-2154-04



**COOLEY**  
33,0 cm, 13"  
Ø 8,0 mm  
75-2155-01

Ø 2,0 mm



**COGSWELL**  
23,0 cm, 9"  
75-2156-23

Saugrohre  
Suction Tubes  
Tubos para aspiración  
Tubi aspirazione



**BYRD**  
20,0 cm, 8"

Ø 1,5 mm	<b>75-2157-15</b>
Ø 2,5 mm	<b>75-2157-25</b>
Ø 3,5 mm	<b>75-2157-35</b>



**HEPP/SCHIEDL**  
22,5 cm, 8<sup>3</sup>/<sub>4</sub>"  
**75-2158-22**

Ø 4,0 mm



**ADSON**  
21,0 cm, 8<sup>1</sup>/<sub>4</sub>"  
**75-2159-21**



**MAGILL**  
17,5 cm, 6<sup>5</sup>/<sub>8</sub>"

Ø 1,0 mm	<b>75-2160-01</b>
Ø 2,0 mm	<b>75-2160-02</b>
Ø 3,0 mm	<b>75-2160-03</b>
Ø 4,0 mm	<b>75-2160-04</b>



**FRAZIER**  
19,0 cm, 7<sup>1</sup>/<sub>2</sub>"

Charr. 6	<b>75-2161-06</b>
Charr. 8	<b>75-2161-08</b>
Charr. 10	<b>75-2161-10</b>
Charr. 12	<b>75-2161-12</b>



**FERGUSON**  
18,0 cm, 7"

Charr. 6	<b>75-2162-06</b>
Charr. 8	<b>75-2162-08</b>
Charr. 10	<b>75-2162-10</b>
Charr. 12	<b>75-2162-12</b>



**POPPE**  
13,0 cm, 5"

Charr. 6	<b>75-2163-06</b>
Charr. 8	<b>75-2163-08</b>
Charr. 10	<b>75-2163-10</b>
Charr. 12	<b>75-2163-12</b>



**C10**  
221 to 230



**Galle, Leber, Niere, Blase, Urologie**  
**Gall, Liver, Kidney, Bladder, Urology**  
**Bilis, Hígado, Riñon, Vejiga, Urología**  
**Bile, Fegato, Rene, Vescica, Urologia**

Nierensteinzangen, Gallensteinzangen  
Kidney Stone Forceps, Gall Stone Forceps  
Pinzas para los cálculos renales, Pinzas para los cálculos biliares  
Pinze per calcoli renali, Pinze per calcoli biliari



**RANDALL**



23,0 cm, 9"  
75-2164-01

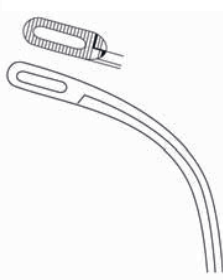

22,0 cm, 8<sup>5</sup>/<sub>8</sub>"  
75-2164-02

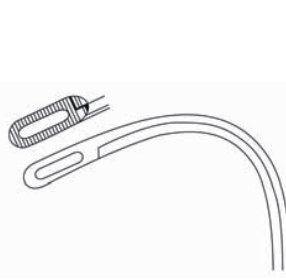

22,0 cm, 8<sup>5</sup>/<sub>8</sub>"  
75-2164-03



22,0 cm, 8<sup>5</sup>/<sub>8</sub>"  
75-2164-04



19,0 cm, 7<sup>1</sup>/<sub>2</sub>"  
75-2164-05

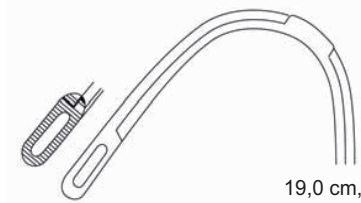

19,0 cm, 7<sup>1</sup>/<sub>2</sub>"  
75-2164-06



**DESJARDINS**  
23,0 cm, 9"



75-2165-01



75-2165-02



**MIXTER**  
22,0 cm, 8<sup>5</sup>/<sub>8</sub>"  
75-2166-22



**MAYO BLAKE**  
20,0 cm, 8"  
75-2168-20



20,0 cm, 8"  
75-2169-20

Gallensteinzangen  
Gall Stone Forceps  
Pinzas para los cálculos biliares  
Pinze per calcoli biliari

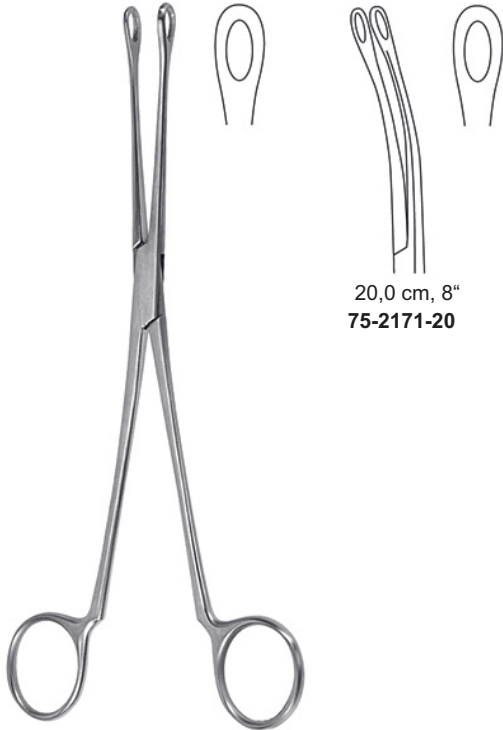

**BLAKE**  
20,0 cm, 8"  
75-2170-20

20,0 cm, 8"  
75-2171-20

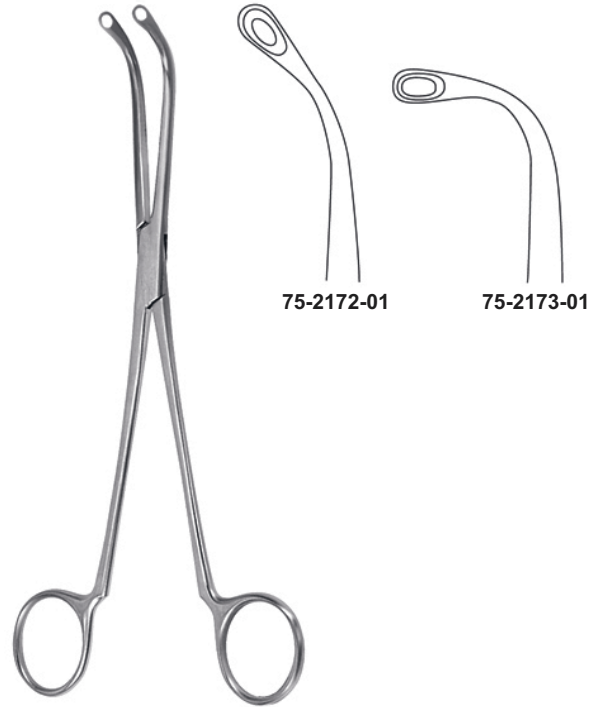

**TURNER-WARWICK**  
18,0 cm, 7"

75-2172-01

75-2173-01

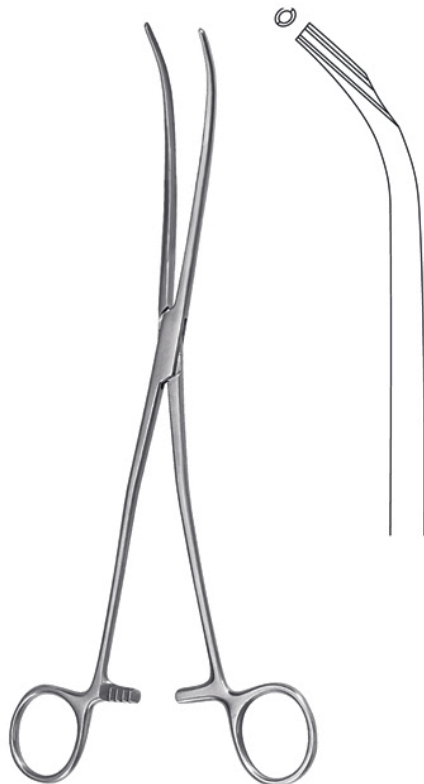

**SÖKELAND**  
24,0 cm, 9½"  
75-2174-24



**CZERNY**  
24,5 cm, 9⅝"  
75-2175-24

**Gallensteinlöffel**  
**Gall Stone Scoops**  
**Cucharillas para los cálculos biliares**  
**Cucchiai per calcoli biliari**



**LUER-KÖRTE**  
 24,0 cm, 9 1/2"

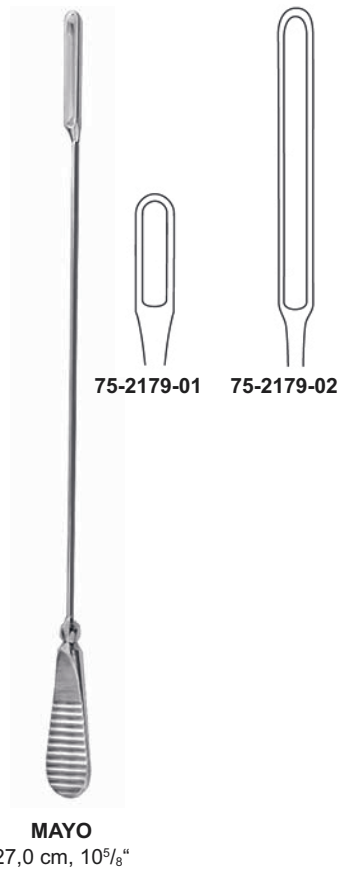
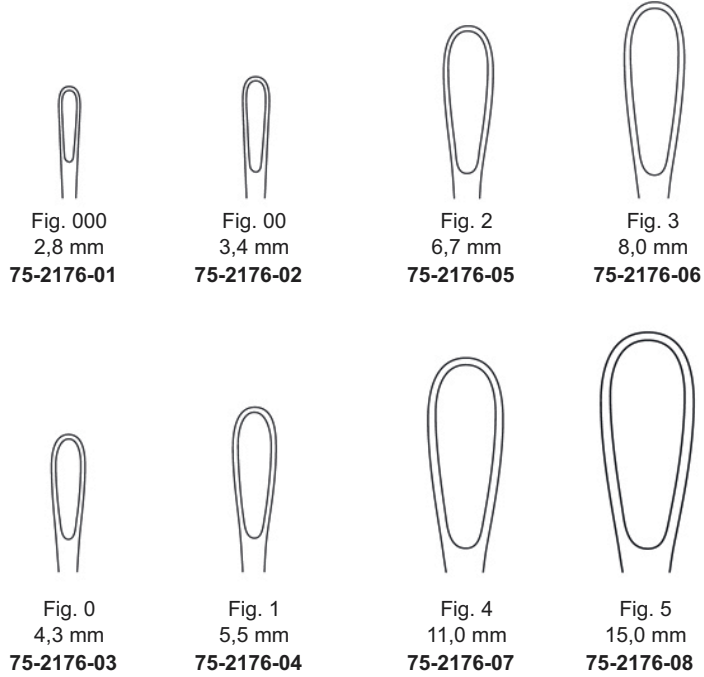



Gallengangsonden, Gallengang Dilatatore  
Gall Duct Probes, Common Bile Duct Dilators  
Sonas p. el conducto biliar, Dilatadores para el conducto biliar  
Dilatatori per condotti biliari, Dilatatori per coledoco



**MAYO**  
32,0 cm, 12<sup>1</sup>/<sub>2</sub>"  
75-2181-32



**OCHSNER**  
35,0 cm, 13<sup>3</sup>/<sub>4</sub>"  
75-2182-35



**DESJARDINS**  
28,0 cm, 11"

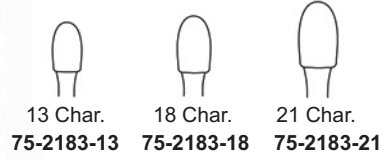

**MOORE**  
30,0 cm, 12"  
75-2185-30

Gallenblasenlöffel  
Gall bladder scoope  
Cuccharilla para la vesicula biliar  
Cucchiaio per colecisti



**DESJARDINS**  
28,0 cm, 11"



**Gallengang Dilatoren**  
**Common Bile Duct Dilators**  
**Dilatadores para el conducto biliar**  
**Dilatatori per coledoco**

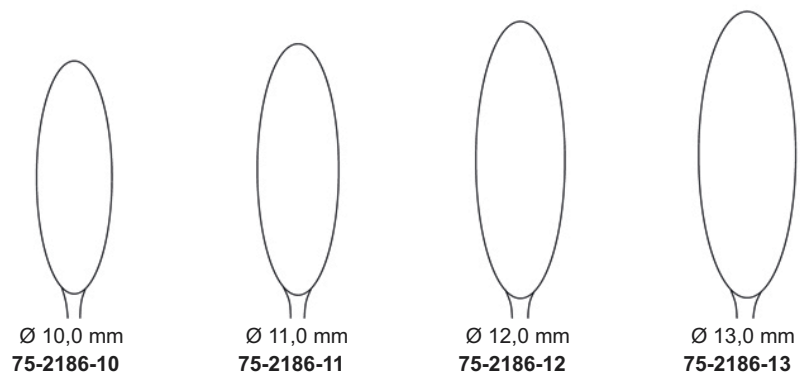
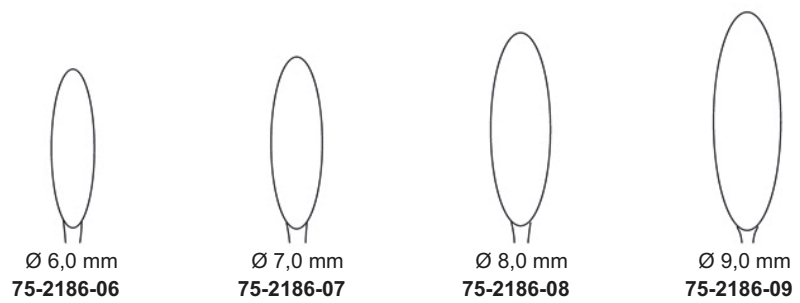
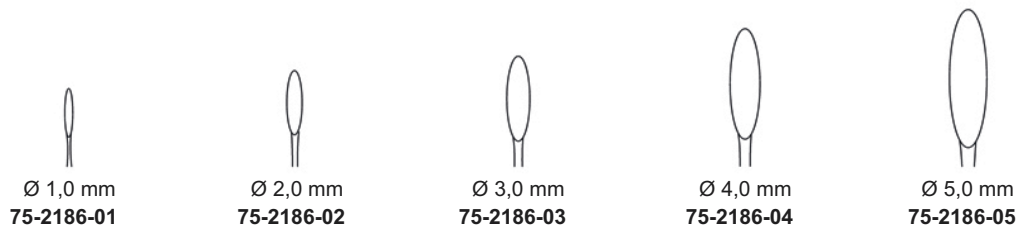

**BAKES**  
30,0 cm, 11<sup>3</sup>/<sub>4</sub>"  
75-2186-30



Blasenwundspreizer  
Bladder Retractors  
Deaparadores para la vejiga  
Divaricatori vescicali

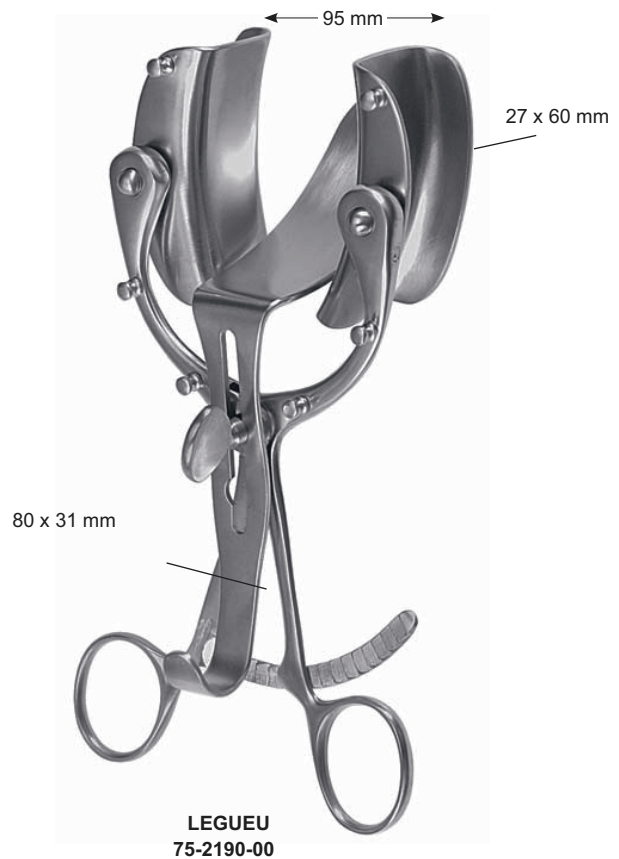

Instrumente für Prostatektomie  
 Prostatectomy Instruments  
 Instrumentos para la prostatectomía  
 Strumenti per operazioni della prostata



**MILLIN**  
 23,0 cm, 9"  
 75-2191-23



**MILLIN**  
 24,0 cm, 9½"  
 75-2192-24



**MILLIN**  
 24,0 cm, 9½"  
 75-2193-24



**MILLIN**  
 23,0 cm, 9"  
 75-2195-23



**MILLIN**  
 28,5 cm, 11¼"  
 75-2196-24

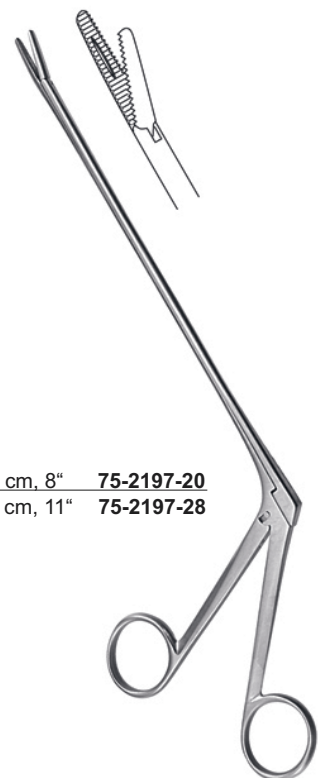

20,0 cm, 8" **75-2197-20**  
 28,0 cm, 11" **75-2197-28**

**MATHIEU**

Prostatahaken, Blasenspatel  
Prostatic Retractors, Bladder Retractor  
Separadores para la prostata, Separadores vesicales  
Retrattori prostatici, Divaricatori vescicali



**YOUNG**  
21,0 cm, 8<sup>1</sup>/<sub>4</sub>"  
75-2198-21



**YOUNG**  
22,0 cm, 8<sup>5</sup>/<sub>8</sub>"  
75-2199-22



**YOUNG**  
21,0 cm, 8<sup>1</sup>/<sub>4</sub>"  
75-2200-21

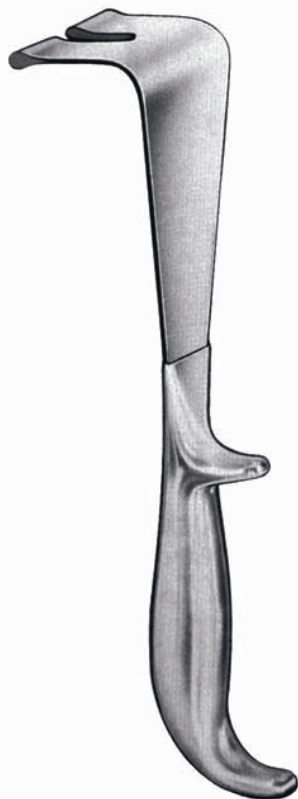

**YOUNG**  
22,0 cm, 8<sup>5</sup>/<sub>8</sub>"  
75-2201-22



**LEGUEU**  
26,0 cm, 10<sup>1</sup>/<sub>4</sub>"  
75-2202-26



**KOCHER**  
23,5 cm, 9<sup>1</sup>/<sub>4</sub>"  
75-2203-23

**Katheter, Penisklemmen**  
**Catheters, Penis Clamp**  
**Sondas, Compresor urétral**  
**Cateteri, Serrapene**



für Männer  
for men  
para hombres  
per uomini

Char. 8	<b>75-2204-08</b>
Char. 10	<b>75-2204-10</b>
Char. 12	<b>75-2204-12</b>
Char. 14	<b>75-2204-14</b>
Char. 16	<b>75-2204-16</b>
Char. 18	<b>75-2204-18</b>
Char. 20	<b>75-2204-20</b>
Char. 22	<b>75-2204-22</b>
Char. 24	<b>75-2204-24</b>

29,0 cm, 11½"



für Frauen  
for women  
para mujeres  
per donne

Char. 6	<b>75-2205-06</b>
Char. 7	<b>75-2205-07</b>
Char. 8	<b>75-2205-08</b>
Char. 9	<b>75-2205-09</b>
Char. 10	<b>75-2205-10</b>
Char. 11	<b>75-2205-11</b>
Char. 12	<b>75-2205-12</b>
Char. 13	<b>75-2205-13</b>
Char. 14	<b>75-2205-14</b>
Char. 15	<b>75-2205-15</b>
Char. 16	<b>75-2205-16</b>
Char. 18	<b>75-2205-18</b>
Char. 20	<b>75-2205-20</b>
Char. 24	<b>75-2205-24</b>

16,0 cm, 6¼"



**STRAUSS**  
11,0 cm, 4⅓"  
**75-2207-11**



**STOCKMANN**  
8,0 cm, 3¼"  
**75-2208-08**

Ø 8,0 mm	<b>75-2206-08</b>
Ø 11,0 mm	<b>75-2206-11</b>
Ø 13,0 mm	<b>75-2206-13</b>
Ø 16,0 mm	<b>75-2206-16</b>
Ø 21,0 mm	<b>75-2206-21</b>
Ø 26,0 mm	<b>75-2206-26</b>
Ø 32,0 mm	<b>75-2206-32</b>

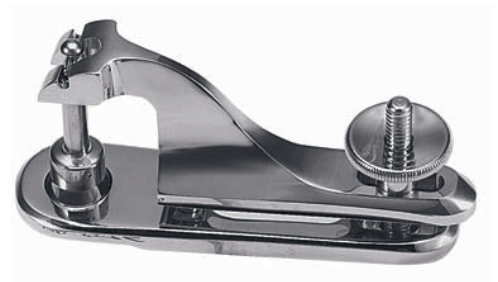

**COMCO**



**Magen, Darm, Mastdarm**  
**Stomach, Intestines, Restum**  
**Estómago, Intestino, Resto**  
**Stomaco, Intestino, Retto**

**Darm- und Gewebefazangen**  
**Intestinal and Tissue Grasping Forceps**  
**Pinzas intestinales y para tejidos**  
**Pinze da presa per intestino e tessuti**

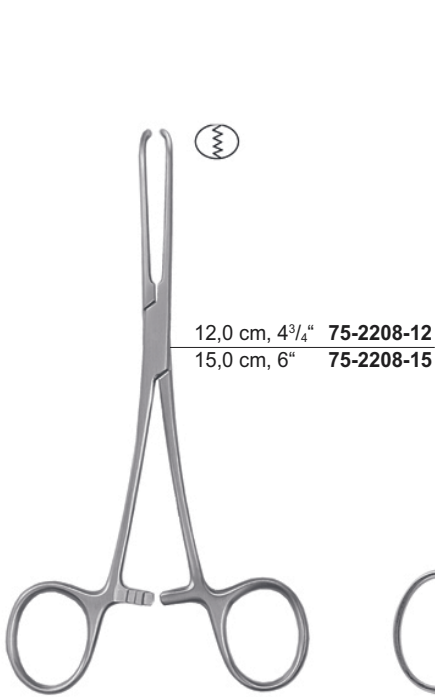

12,0 cm, 4<sup>3</sup>/<sub>4</sub>" **75-2208-12**  
 15,0 cm, 6" **75-2208-15**

**ALLIS-BABY**

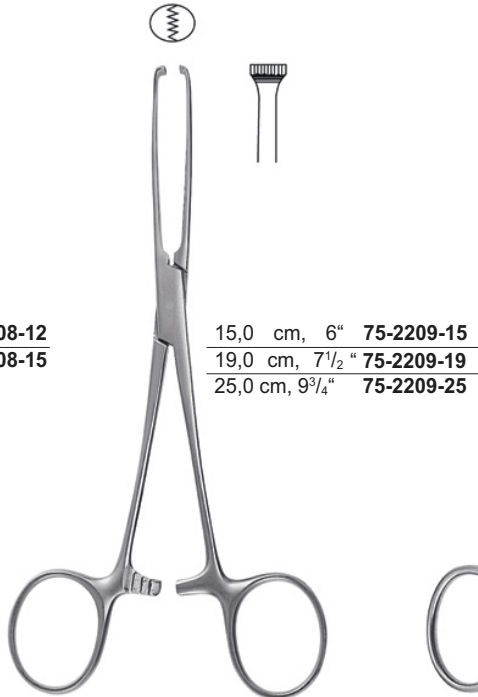

15,0 cm, 6" **75-2209-15**  
 19,0 cm, 7<sup>1</sup>/<sub>2</sub>" **75-2209-19**  
 25,0 cm, 9<sup>3</sup>/<sub>4</sub>" **75-2209-25**

**ALLIS**

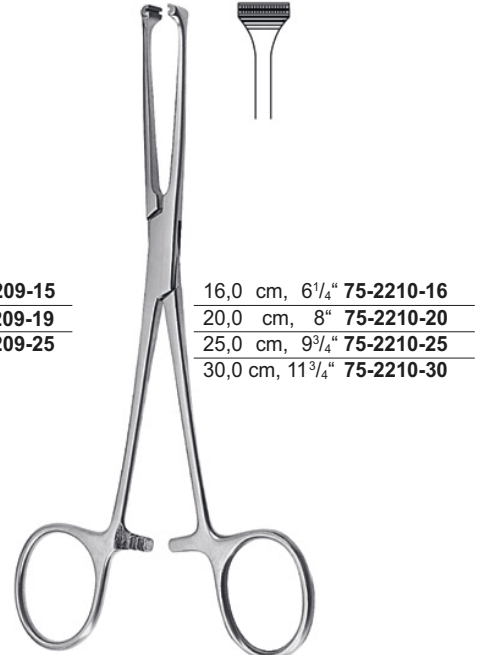

16,0 cm, 6<sup>1</sup>/<sub>4</sub>" **75-2210-16**  
 20,0 cm, 8" **75-2210-20**  
 25,0 cm, 9<sup>3</sup>/<sub>4</sub>" **75-2210-25**  
 30,0 cm, 11<sup>3</sup>/<sub>4</sub>" **75-2210-30**

**ALLIS-ATRAUMA**



15,5 cm, 6" **75-2211-15**  
 20,0 cm, 8" **75-2211-20**  
 23,0 cm, 9" **75-2211-23**

**ALLEN**

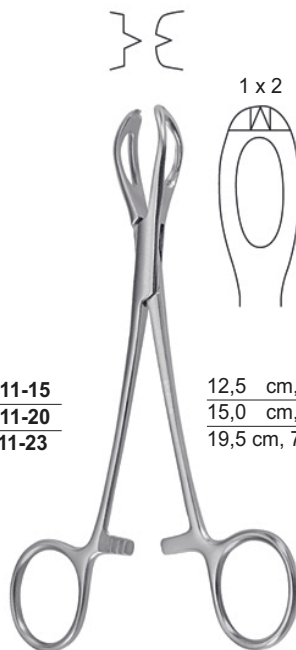

12,5 cm, 5" **75-2212-12**  
 15,0 cm, 6" **75-2212-15**  
 19,5 cm, 7<sup>3</sup>/<sub>4</sub>" **75-2212-19**

**LANE**

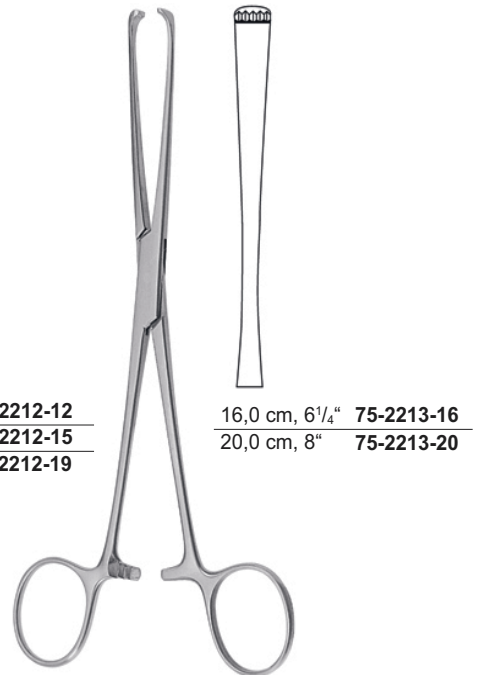

16,0 cm, 6<sup>1</sup>/<sub>4</sub>" **75-2213-16**  
 20,0 cm, 8" **75-2213-20**

**LOCKWOOD-ALLIS**



**Darm- und Gewebefäßzangen**  
**Intestinal and Tissue Grasping Forceps**  
**Pinzas intestinales y para tejidos**  
**Pinze da presa per intestino e tessuti**



15,0 cm, 6" 75-2214-15  
19,0 cm, 7½" 75-2214-19

**JUDD-ALLIS**



**LITTLEWOOD**  
18,5 cm, 7¼"  
75-2215-16



**ALLIS-ADAIR**  
15,5 cm, 6"  
75-2216-15



**BOYS-ALLIS**  
15,5 cm, 6"  
75-2217-15



**THOMS-ALLIS**  
20,0 cm, 8"  
75-2218-20



**ALLIS**  
20,0 cm, 8"  
75-2219-20

**Darm- und Gewebefaszangen**  
**Intestinal and Tissue Grasping Forceps**  
**Pinzas intestinales y para tejidos**  
**Pinze da presa per intestino e tessuti**



**LOCKWOOD**  
 20,0 cm, 8"  
 75-2220-20

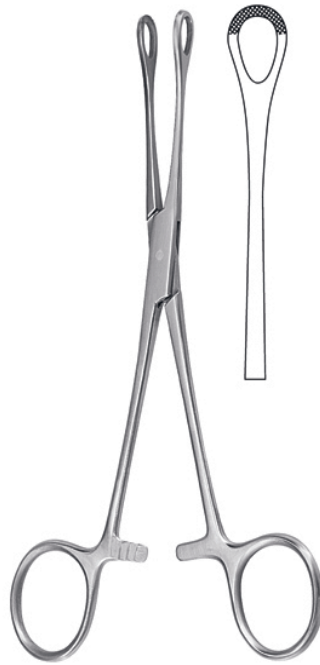

**WILLIAMS**  
 16,0 cm, 6 1/4"  
 75-2221-16



16,0 cm, 6 1/4" **75-2222-16**  
 18,0 cm, 7" **75-2222-18**  
 20,0 cm, 8" **75-2222-20**  
 24,0 cm, 9 1/2" **75-2222-24**



**BABCOCK-ATRAUMA**

16,0 cm, 6 1/4" **75-2223-16**  
 20,0 cm, 8" **75-2223-20**



**BABCOCK-TC**

16,0 cm, 6 1/4" **75-2224-16**  
 20,0 cm, 8" **75-2224-20**



**DUVAL-TC**  
 20,0 cm, 8"  
 75-2225-20

Darmklemmen  
Intestinal Clamp Forceps  
Pinzas-clamps intestinales  
Pinze intestinali



**DUVAL**

18,0 cm, 7"	<b>75-2226-18</b>
20,0 cm, 8"	<b>75-2226-20 75-2227-20</b>
23,0 cm, 9"	<b>75-2227-23</b>

Darm- und Gewebefaßzangen  
Intestinal and Tissue Grasping Forceps  
Pinzas intestinales y para tejidos  
Pinze da presa per intestino e tessuti



**BABY-DOYEN**  
18,0 cm, 7"

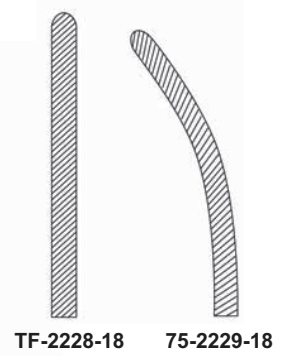

**DOYEN**

21,0 cm, 8 <sup>1</sup> / <sub>4</sub> "	<b>75-2230-21</b>	21,0 cm, 8 <sup>1</sup> / <sub>4</sub> "	<b>75-2231-21</b>
23,0 cm, 9"	<b>75-2230-23</b>	23,0 cm, 9"	<b>75-2231-23</b>

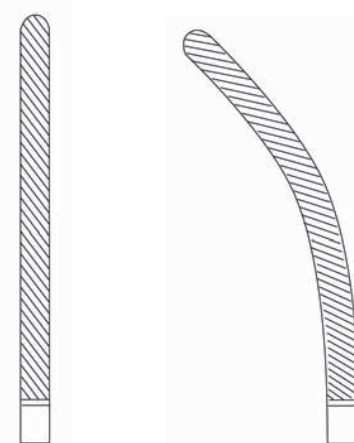

**Darmklemmen**  
**Intestinal Clamp Forceps**  
**Pinzas-clamps intestinales**  
**Pinze intestinali**



**DOYEN**

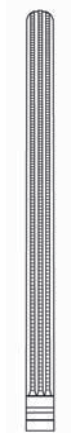

21,0 cm, 8<sup>1</sup>/<sub>4</sub>" **75-2232-21**  
23,0 cm, 9" **75-2232-23**

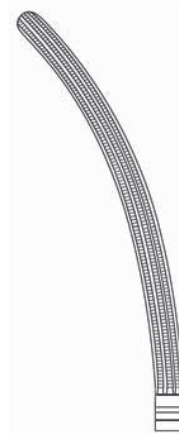

21,0 cm, 8<sup>1</sup>/<sub>4</sub>" **75-2233-21**  
23,0 cm, 9" **75-2233-23**

mit atraumatischer Zahnung  
with atraumatic serration  
con bacos atraumáticas  
con morsi atraumatici



**KOCHER**

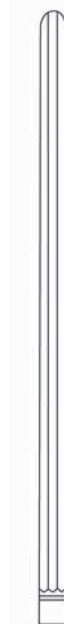

22,0 cm, 8<sup>5</sup>/<sub>8</sub>" **75-2234-22**  
25,0 cm, 9<sup>3</sup>/<sub>4</sub>" **75-2234-25**  
28,0 cm, 11" **75-2234-28**



22,0 cm, 8<sup>5</sup>/<sub>8</sub>" **75-2235-22**  
25,0 cm, 9<sup>3</sup>/<sub>4</sub>" **75-2235-25**  
28,0 cm, 11" **75-2235-28**

Darmklemmen  
Intestinal Clamp Forceps  
Pinzas-clamps intestinales  
Pinze intestinali



mit atraumatischer Zahnung  
with atraumatic serration  
con bacos atraumáticas  
con morsi atraumatici

**KOCHER**

22,0 cm, 8<sup>5</sup>/<sub>8</sub>" 75-1236-22  
25,0 cm, 9<sup>3</sup>/<sub>4</sub>" 75-1236-25  
28,0 cm, 11" 75-1236-28



22,0 cm, 8<sup>5</sup>/<sub>8</sub>" 75-1237-22  
25,0 cm, 9<sup>3</sup>/<sub>4</sub>" 75-1237-25  
28,0 cm, 11" 75-1237-28



**MAYO-ROBSON**

21,0 cm, 8<sup>1</sup>/<sub>4</sub>" 75-2238-21  
23,0 cm, 9" 75-2238-23  
25,0 cm, 9<sup>3</sup>/<sub>4</sub>" 75-2238-25



21,0 cm, 8<sup>1</sup>/<sub>4</sub>" 75-2239-21  
23,0 cm, 9" 75-2239-23  
25,0 cm, 9<sup>3</sup>/<sub>4</sub>" 75-2239-25

**Darmklemmen**  
**Intestinal Clamp Forceps**  
**Pinzas-clamps intestinales**  
**Pinze intestinali**



**MAYO-ROBSON**

21,0 cm, 8<sup>1</sup>/<sub>4</sub>" **75-2240-21**  
23,0 cm, 9" **75-2240-23**  
25,0 cm, 9<sup>3</sup>/<sub>4</sub>" **75-2240-25**

mit atraumatischer Zahnung  
with atraumatic serration  
con bacos atraumáticas  
con morsi atraumatici



21,0 cm, 8<sup>1</sup>/<sub>4</sub>" **75-2241-21**  
23,0 cm, 9" **75-2241-23**  
25,0 cm, 9<sup>3</sup>/<sub>4</sub>" **75-2241-25**

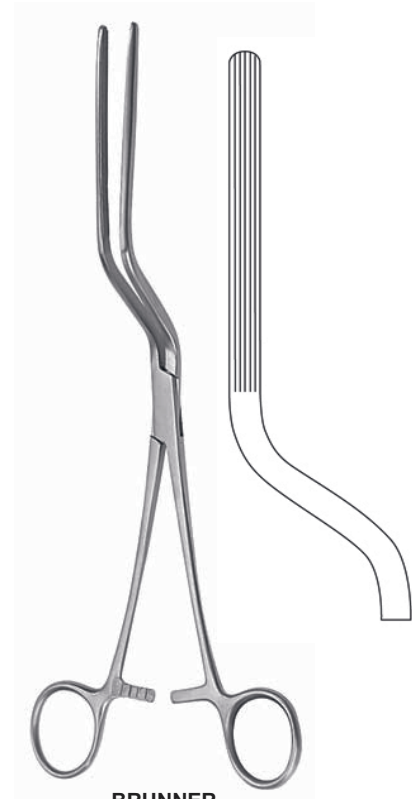

**BRUNNER**  
24,0 cm, 9<sup>1</sup>/<sub>2</sub>"  
**75-2242-24**

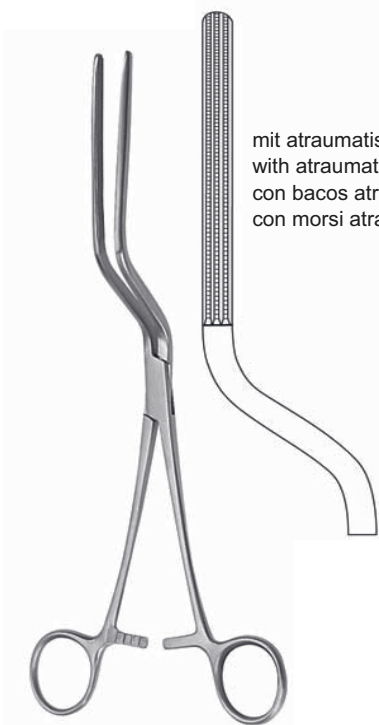

24,0 cm, 9<sup>1</sup>/<sub>2</sub>"  
**75-2243-24**

mit atraumatischer Zahnung  
with atraumatic serration  
con bacos atraumáticas  
con morsi atraumatici

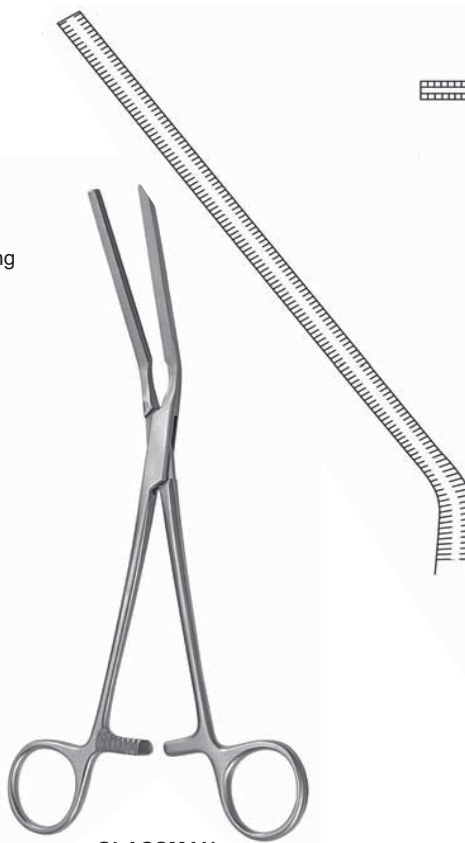

**GLASSMAN**  
23,0 cm, 9"  
**75-2244-23**



**GLASSMAN**  
23,5 cm, 9<sup>1</sup>/<sub>4</sub>"  
**75-2245-23**

**Darm- und Magenquetschklemmen**  
**Intestinal and Stomach Clamps**  
**Pinzas-clamps intestinales y estomacales**  
**Pinze/Clamp per intestino e stomaco**



Maullänge  
length of jaws  
longitud de la boca  
bocche lungh.

5,0 cm, 2"	<b>75-2246-05</b>
7,0 cm, 2 1/2"	<b>75-2246-07</b>
10,0 cm, 4"	<b>75-2246-10</b>

**DE MARTEL-WOLFSON**



**DE MARTEL-WOLFSON**

8,5 cm, 3 1/2"  
**75-2247-08**



**DE MARTEL-WOLFSON**

26,0 cm, 10 1/4"  
**75-2248-26**



**BABY-PAYR**  
15,0 cm, 6"



**75-2249-15**  
mit Stift  
with pin  
con espiga  
con perno



**75-2250-15**  
ohne Stift  
without pin  
sin espiga  
senza perno



**PAYR**



21,0 cm, 8 1/4" **75-2252-21**  
29,0 cm, 11 1/2" **75-2252-29**

mit Stift  
with pin  
con espiga  
con perno



**75-2253-21**  
**75-2253-29**

ohne Stift  
without pin  
sin espiga  
senza perno

Darm- und Magenklappen  
 Intestinal and Stomach Clamp Forceps  
 Pinzas-clamps intestinales y estomacales  
 Pinze per intestino e stomaco



75-2254-30

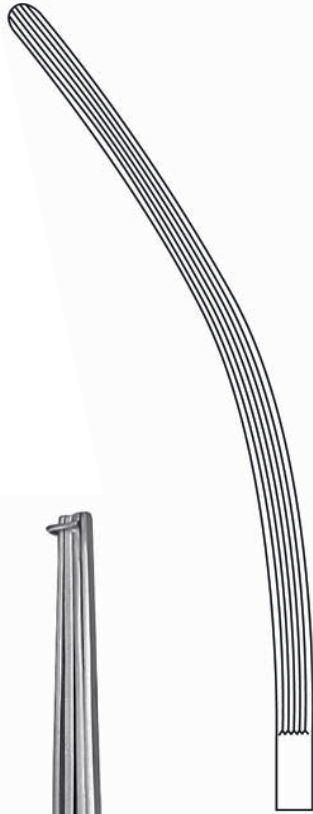

75-2255-30



75-2256-33



75-2257-33

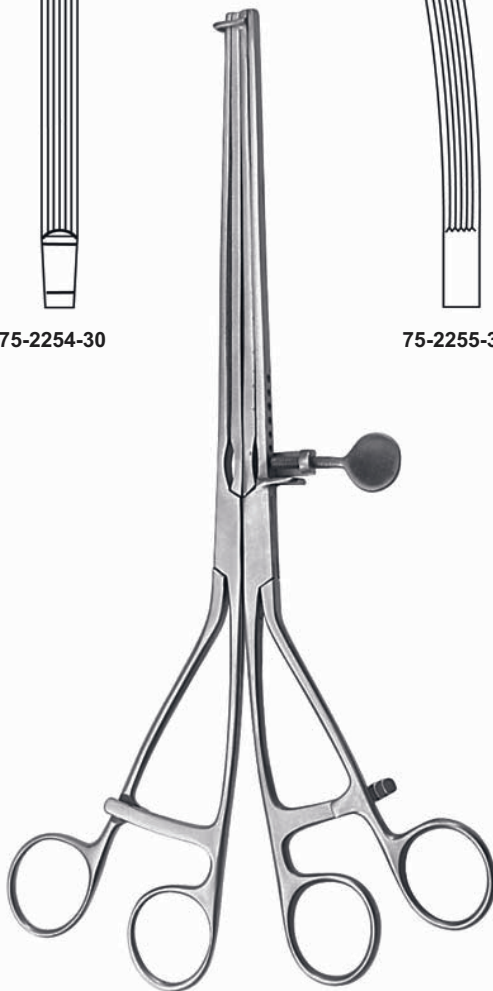

**LANE**  
 30,0 cm, 11<sup>3</sup>/<sub>4</sub>"

mit atraumatischer Zahnung  
 with atraumatic serration  
 con bacos atraumáticas  
 con morsi atraumatici



**SCUDDER**  
 33,0 cm, 13"



Rektum-Anastomosenklemmen  
Sigmoid Anastomosis Forceps  
Pinzas para anastomosis de recto  
Pinze per anastomosi de retto



19,0 cm, 7 1/2"  
75-2258-19

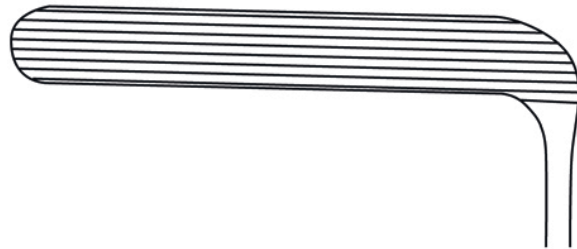

HAYES

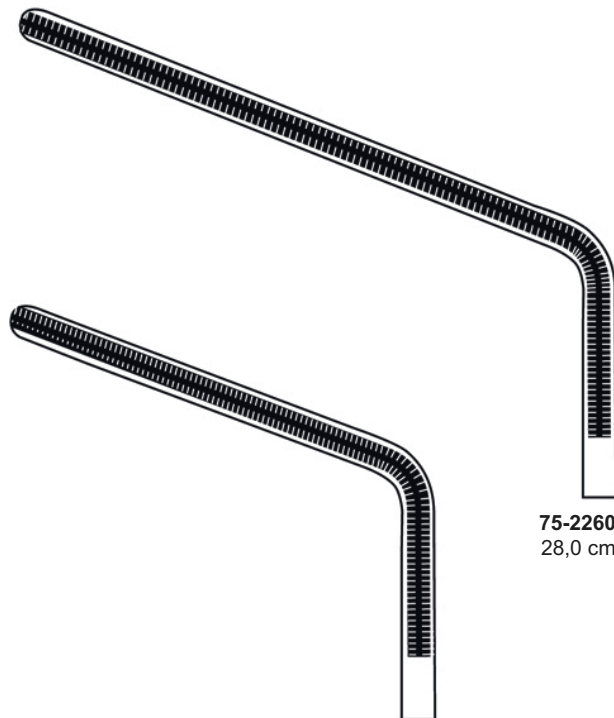

75-2260-28  
28,0 cm, 11"

75-2259-26  
26,0 cm, 10"

Mastdarm-Rektum-Spekula  
Rectal Specula  
Espéculos para el recto  
Speculi rettali

17 x 89 mm



**SIMS**  
15,0 cm, 6"  
75-2261-15

17 x 89 mm



**SIMS**  
15,0 cm, 6"  
75-2262-15

25 x 89 mm



**MATHIEU**  
21,0 cm, 8<sup>1</sup>/<sub>4</sub>"  
75-2263-21

75 x 23 mm



**SMITH-BUIE**  
15,0 cm, 6"  
75-2264-15

**Analnspreizer, Sphinkterskope, Anuskope**  
**Rectal Retractor, Sphincteroscopes, Anoscope**  
**Separadores para el recto, Esfinteroscopios, Anoscopios**  
**Dilatatori per l'ano ed il retti, Sfinteroscopi, Anoscopi**

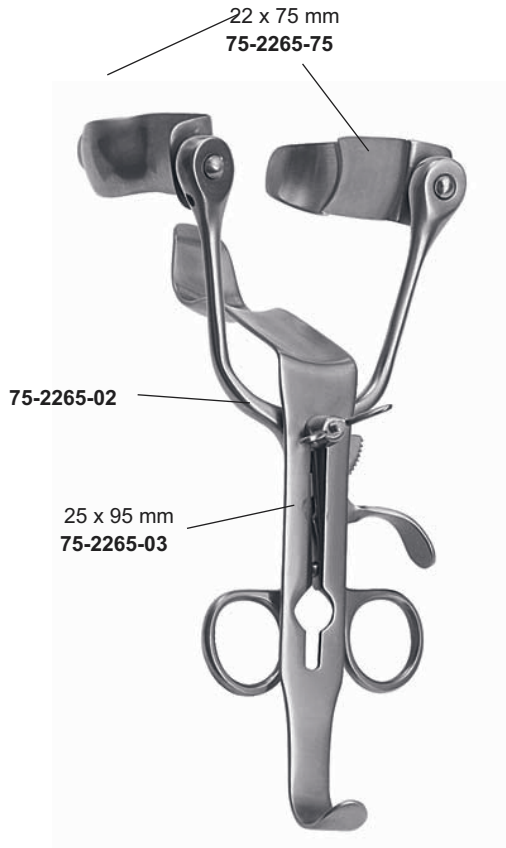

**ALAN PARKS**  
13,5 cm, 5<sup>3</sup>/<sub>8</sub>"  
**75-1147-00**



Kaltlichtkammer für Proktoskope  
Cold-light clip for proctoscopes  
Clip para luz fría con proctoscopios  
Clip per luce fredda con protoscopi

**75-2266-00**

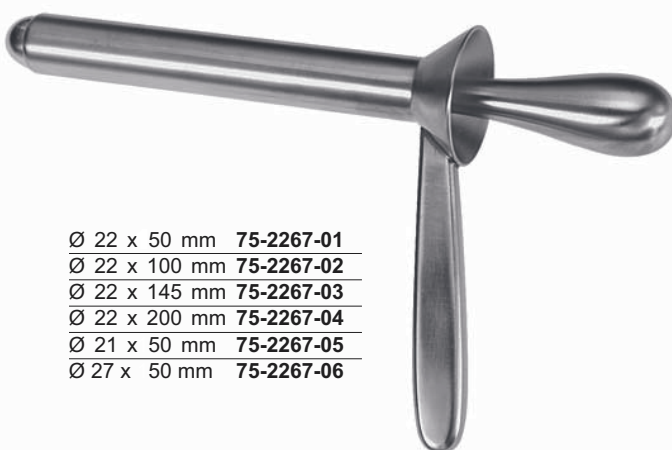

**HAYES**



**HIRSCHMANN**

Anuskope, Proktoskope  
Anoscope, Proctoscopes  
Anoscopios, Proctoscopios  
Anoscopi, Protoscopi



Ø 22 x 65 mm **75-2269-22**  
Ø 30 x 65 mm **75-2269-30**

**CHELSEA EATON**



ohne Kaltlichtträger  
without cold light carrier  
sin portador para luz fría  
senza luce fredda

**IVES FANSLER**  
Ø 22 mm  
**75-2270-01**

mit Kaltlichtträger  
with cold light carrier  
con portador para luz fría  
con luce fredda

**IVES FANSLER**  
Ø 22 mm  
**75-2271-02**



Ø 17 x 65 mm **75-2272-01**  
Ø 17 x 80 mm **75-2272-02**  
Ø 20 x 65 mm **75-2272-03**  
Ø 20 x 80 mm **75-2272-04**  
Ø 24 x 65 mm **75-2272-05**  
Ø 24 x 80 mm **75-2272-06**

**MORGAN**



**055-1000-02**

**FANSLER**

Ø 25 x 65 mm **75-2273-25**  
Ø 29 x 65 mm **75-2273-29**  
Ø 38 x 70 mm **75-2273-38**

**Mastdarm-Biopsiezangen**  
**Rectal Biopsy Forceps**  
**Pinzas sacabocado para biopsia rectal**  
**Pinze taglianti per biopsia rettale**

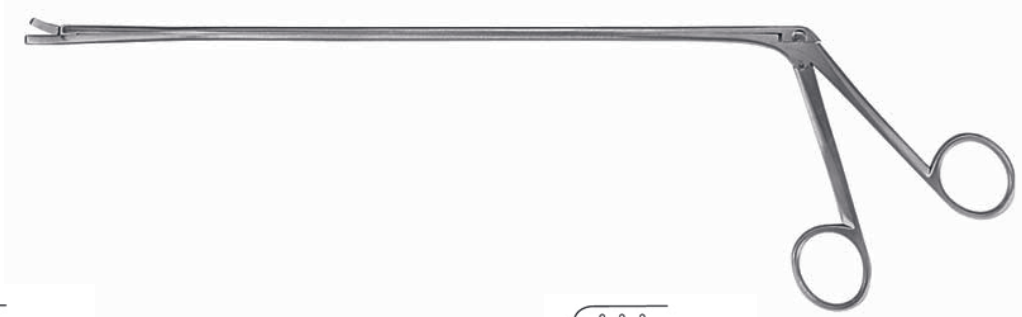

28,0 cm, 11" **75-2274-28**  
35,0 cm, 13<sup>3</sup>/<sub>4</sub>" **75-2274-35**  
42,0 cm, 16<sup>1</sup>/<sub>2</sub>" **75-2274-42**

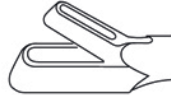

28,0 cm, 11" **75-2275-28**  
35,0 cm, 13<sup>3</sup>/<sub>4</sub>" **75-2275-35**  
42,0 cm, 16<sup>1</sup>/<sub>2</sub>" **75-2275-42**

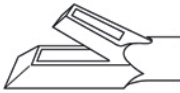

28,0 cm, 11" **75-2276-28**  
35,0 cm, 13<sup>3</sup>/<sub>4</sub>" **75-2276-35**  
42,0 cm, 16<sup>1</sup>/<sub>2</sub>" **75-2276-42**

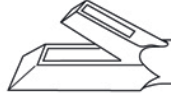

28,0 cm, 11" **75-2277-28**  
35,0 cm, 13<sup>3</sup>/<sub>4</sub>" **75-2277-35**  
42,0 cm, 16<sup>1</sup>/<sub>2</sub>" **75-2277-42**



Hämorrhoiden-Ligator mit Ladekonus  
Haemorrhoidal ligator with loading attachment  
Ligador para hemorroides con cono de carga  
Legatori emorroidali con carica a cono



**RUDD**  
**75-2280-00**

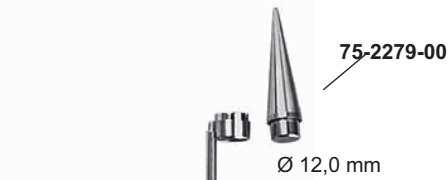

Hämorrhoiden-Ligator mit Ladekonus  
Haemorrhoidal ligator with loading attachment  
Ligador para hemorroides con cono de carga  
Legatori emorroidali con carica a cono



**MC GIVNEY**  
**75-2281-00**

Hämorrhoiden-Faßzangen, Fistelsonden  
Haemorrhoidal Forceps, Fistula probes  
Pinza-clamps para hemorroides, Sondas para fistula  
Pinze per emorroidi. Sonde per fistola



**MC GIVNEY**  
19,0 cm, 7½"  
75-2282-19



**MC GIVNEY**  
19,0 cm, 7½"  
75-2283-19



**PRATT**  
21,0 cm, 8¼"



75-2284-01



75-2284-02



75-2284-03

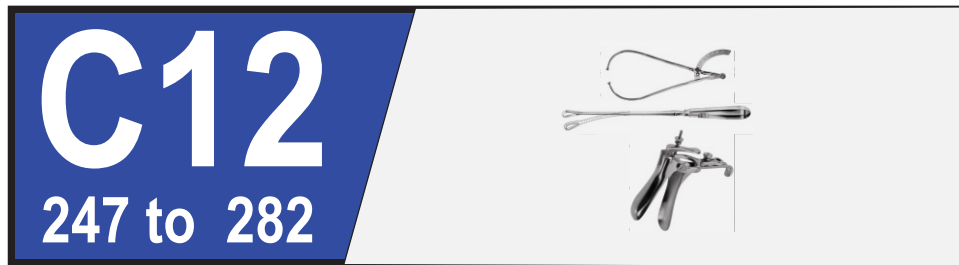

**Gynäkologie, Gebusthilfe**

**Gynecology, Obstetrics**

**Ginecología, Obstetricia**

**Ginecologia, Ostetricia**

**Scheidenspekula**  
**Vaginal Specula**  
**Espéculos vaginales**  
**Speculi vaginali**

für Kinder  
for children  
para niños  
per bambini



**COLLIN**  
65 x 10 mm  
75-2285-00

für Jungfrauen  
for virgins  
para vírgenes  
per vergini



**COLLIN**  
65 x 10 mm  
75-2286-00

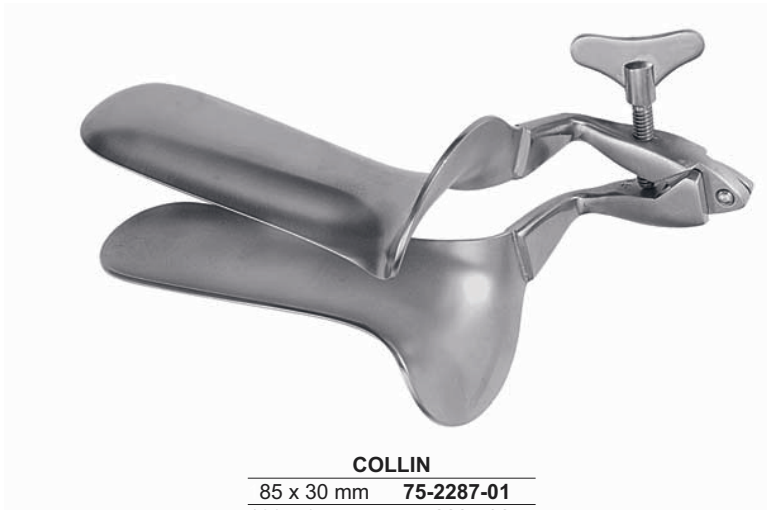

**COLLIN**

85 x 30 mm	75-2287-01
100 x 35 mm	75-2287-02
110 x 40 mm	75-2287-03



**CUSCO**

80 x 24 mm	75-2288-01
80 x 32 mm	75-2288-02
98 x 16 mm	75-2288-03
105 x 25 mm	75-2288-04
107 x 29 mm	75-2288-05
115 x 35 mm	75-2288-06



Scheidenspekula  
Vaginal Specula  
Espécucos vaginales  
Speculi vaginali



zentrale Stellschraube  
central fixation screw  
tornillo de sujeto central  
vite di regolazione centrale

**CUSCO**

75 x 32 mm	<b>75-2289-01</b>
85 x 36 mm	<b>75-2289-02</b>
95 x 37 mm	<b>75-2289-03</b>



seitliche Stellschraube  
lateral fixation screw  
tornillo de sujeto lateral  
vite di regolazione laterale

für Jungfrauen  
for virgins  
para virgenes  
per vergini

**CUSCO**

75 x 17 mm	<b>75-2290-00</b>
------------	-------------------



seitliche Stellschraube  
lateral fixation screw  
tornillo de sujeto lateral  
vite di regolazione laterale

**CUSCO**

75 x 32 mm	<b>75-2291-01</b>
85 x 35 mm	<b>75-2291-02</b>
100 x 35 mm	<b>75-2291-03</b>



Schweizer Modell  
Swiss pattern  
Modelo suizo  
Modello svizzero

**CUSCO**

90 x 23-25 mm	<b>75-2292-01</b>
100 x 25-27 mm	<b>75-2292-02</b>
110 x 27-30 mm	<b>75-2292-03</b>

Scheidenspekula  
Vaginal Specula  
Espéculos vaginales  
Speculi vaginali



**GRAVE**

75 x 20 mm	<b>75-2293-01</b>
95 x 35 mm	<b>75-2293-02</b>
115 x 35 mm	<b>75-2293-03</b>



**PEDERSON**

75 x 13 mm	<b>75-2294-01</b>
100 x 22 mm	<b>AK-2294-02</b>
120 x 25 mm	<b>75-2294-03</b>



**SEMM**

90 x 14-18 mm	<b>75-2295-01</b>
100 x 17-20 mm	<b>75-2295-02</b>
100 x 25-30 mm	<b>75-2295-03</b>



**WEISSBARTH**  
21,0 cm, 8 1/4"  
**75-2296-00**

Scheidenspekula  
Vaginal Specula  
Espéculos vaginales  
Speculi vaginali



1,14 kg

**AUVARD**  
75 x 38 mm  
75-2297-00



1,14 kg

**AUVARD**  
75 x 38 mm  
75-2298-00

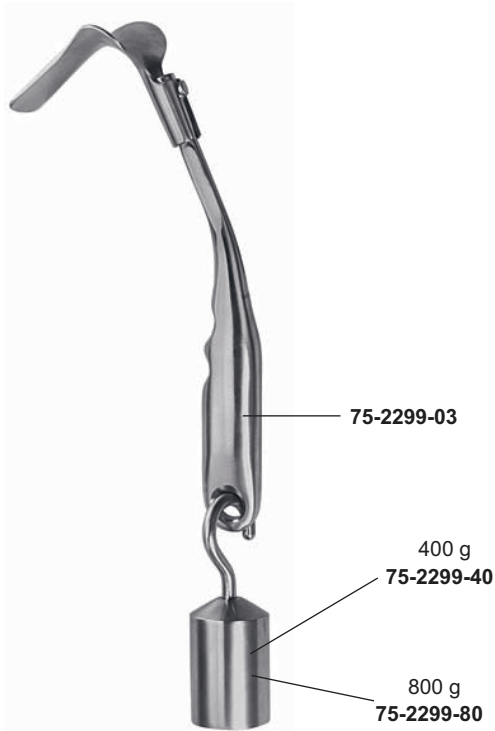

**SCHERBACK**  
75-2299-00

koplett, complete, completo, completo

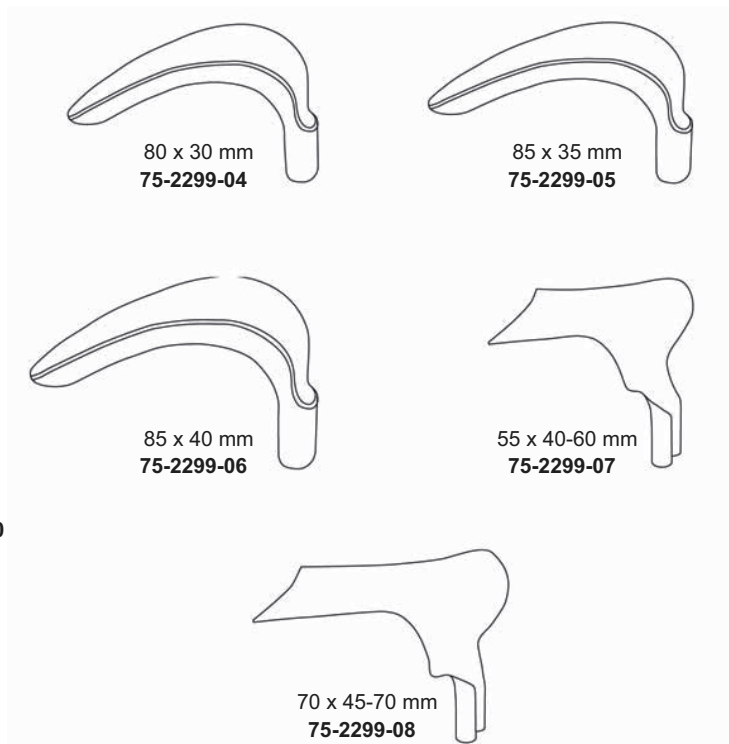

Scheidenspekula  
Vaginal Specula  
Espéculos vaginales  
Speculi vaginali



Satz  
Set  
Juego  
Set

**KRISTELLER**  
Fig. 1 **75-2300-01**  
Fig. 2 **75-2300-02**  
Fig. 3 **75-2300-03**



Spekula allein, fl ach  
Specula only, fl at hollow  
Espéculos suelto, con huecos planos  
Solo speculi, piatta

**KRISTELLER**  
105 x 26 mm **75-2301-01**  
105 x 28 mm **75-2301-02**  
105 x 33 mm **75-2301-03**

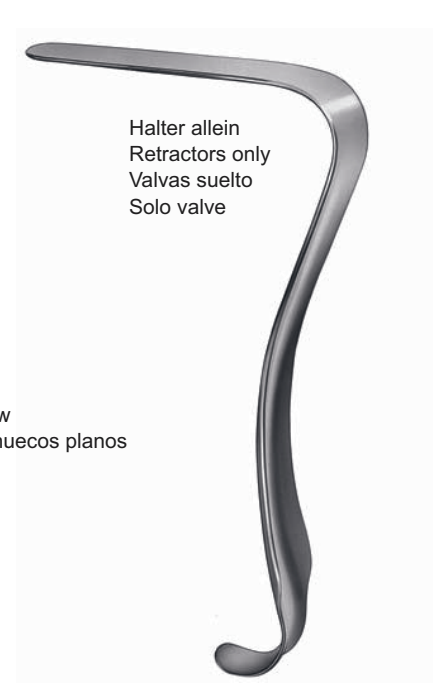

Halter allein  
Retractors only  
Valvas suelto  
Solo valve

**KRISTELLER**  
115 x 22 mm **75-2302-01**  
115 x 24 mm **75-2302-02**  
115 x 29 mm **75-2302-03**



Satz  
Set  
Juego  
Set

**KRISTELLER**  
Fig. 1 **75-2303-01**  
Fig. 2 **75-2303-02**  
Fig. 3 **75-2303-03**

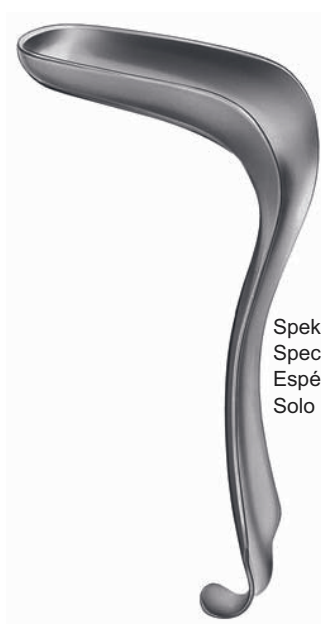

Spekula allein, fl ach  
Specula only, fl at hollow  
Espéculos suelto, con huecos planos  
Solo speculi, piatta

**KRISTELLER**  
110 x 27 mm **75-2304-01**  
110 x 30 mm **75-2304-02**  
110 x 36 mm **75-2304-03**

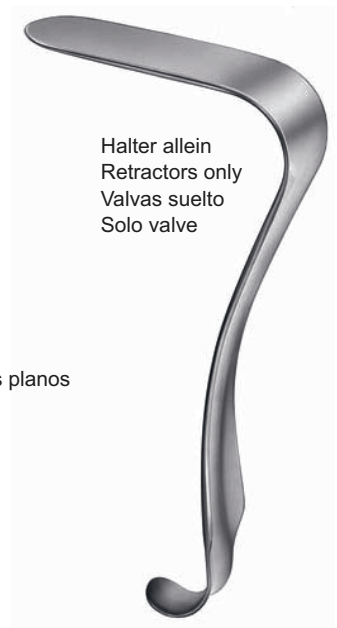

Halter allein  
Retractors only  
Valvas suelto  
Solo valve

**KRISTELLER**  
115 x 23 mm **75-2305-01**  
115 x 26 mm **75-2305-02**  
115 x 32 mm **75-2305-03**

Scheidenspekula  
Vaginal Specula  
Especulos vaginales  
Speculi vaginali

Satz  
Set  
Juego  
Set



Spekula allein  
Specula only  
Especulos suelto  
Solo speculi

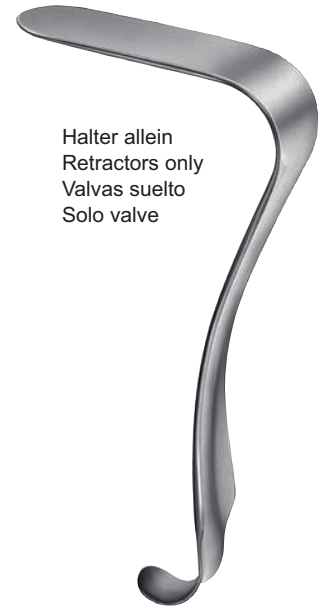

Halter allein  
Retractors only  
Valvas suelto  
Solo valve

**KRISTELLER**

Fig. 0 **75-2306-00**  
Fig. 1 **75-2306-01**  
Fig. 2 **75-2306-02**  
Fig. 3 **75-2306-03**

**KRISTELLER**

70 x 15 mm **75-2307-00**  
70 x 27 mm **75-2307-01**  
80 x 30 mm **75-2307-02**  
90 x 36 mm **75-2307-03**

**KRISTELLER**

75 x 10 mm **75-2308-00**  
75 x 23 mm **75-2308-01**  
85 x 26 mm **75-2308-02**  
100 x 32 mm **75-2308-03**

konisch, für Jungfrauen  
conical blades, for virgins  
valvos cónicos, para vírgenes  
valve coniche, per vergini

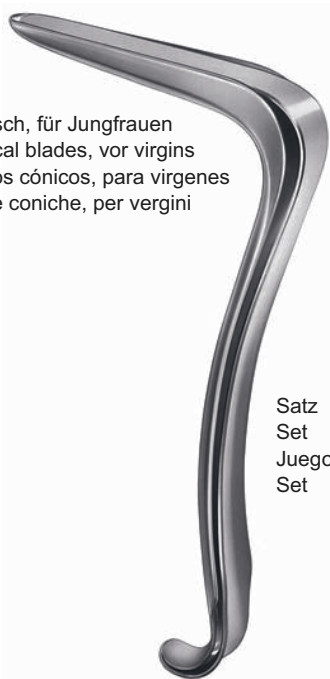

Satz  
Set  
Juego  
Set



Spekula allein  
Specula only  
Especulos suelto  
Solo speculi



Halter allein  
Retractors only  
Valvas suelto  
Solo valve

**KRISTELLER**

Fig. 00 **75-2309-01**  
Fig. 0 **75-2309-02**

**KRISTELLER**

105 x 18 mm **75-2310-01**  
105 x 21 mm **75-2310-02**

**KRISTELLER**

110 x 14 mm **75-2311-01**  
110 x 17 mm **75-2311-02**

Scheidenspekula  
Vaginal Specula  
Especulos vaginales  
Speculi vaginali

leicht hohl  
slightly-concave  
ligeremente concavos  
leggeremente concavi

Fig	a x b	
1	55 x 35 mm	75-2312-01
2	85 x 35 mm	75-2312-02
3	115 x 35 mm	75-2312-03
1	55 x 45 mm	75-2313-01
2	85 x 45 mm	75-2313-02
3	115 x 45 mm	75-2313-03
4	160 x 45 mm	75-2313-04
1	55 x 60 mm	75-2314-01
2	85 x 60 mm	75-2314-02
3	115 x 60 mm	75-2314-03
4	160 x 60 mm	75-2314-04

**DOYEN**  
23,0 cm, 9"

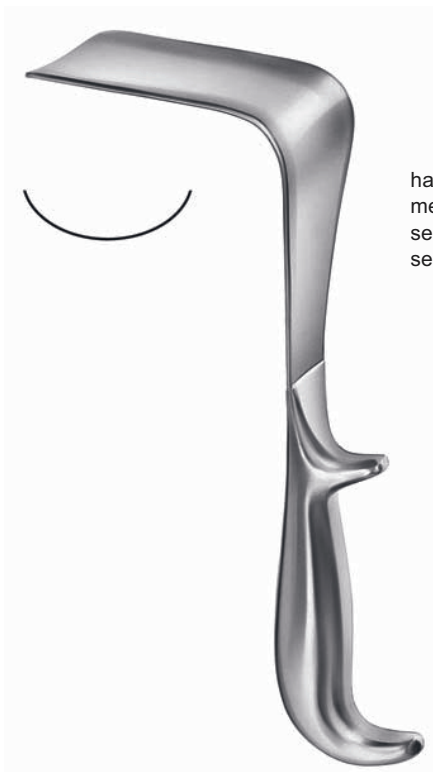

halb-hohl  
medium-concave  
semi-concavos  
semi-concavi

Fig	a x b	
1	55 x 35 mm	75-2315-01
2	85 x 35 mm	75-2315-02
3	115 x 35 mm	75-2315-03
1	55 x 45 mm	75-2316-01
2	85 x 45 mm	75-2316-02
3	115 x 45 mm	75-2316-03
1	55 x 60 mm	75-2317-01
2	85 x 60 mm	75-2317-02
3	115 x 60 mm	75-2317-03

**DOYEN**  
23,0 cm, 9"

Scheidenspekula  
Vaginal Specula  
Espéculos vaginales  
Speculi vaginali

Satz  
Set  
Juego  
Set



Spekula allein  
Specula only  
Espéculos suelto  
Solo speculi

Halter allein  
Retractors only  
Valvas suelto  
Solo valve

KALLMORGEN	
70 x 40 mm	<b>75-2318-01</b>
90 x 40 mm	<b>75-2318-02</b>

KALLMORGEN	
70 x 40 mm	<b>75-2319-01</b>
90 x 40 mm	<b>75-2319-02</b>

KALLMORGEN	
70 x 40 mm	<b>75-2320-01</b>
90 x 40 mm	<b>75-2320-02</b>



70 x 15 mm

**KRISTELLER**  
17,0 cm, 6<sup>3</sup>/<sub>4</sub>"  
**75-2321-17**

75 x 39 mm

**KALLMORGEN**  
17,0 cm, 6<sup>3</sup>/<sub>4</sub>"  
**75-2322-17**



**JACKSON**  
75 x 38 mm **75-2323-01**  
90 x 38 mm **75-2323-02**  
100 x 38 mm **75-2323-03**

Scheidenspekula  
Vaginal Specula  
Espéculos vaginales  
Speculi vaginali

76 x 25 mm



70 x 22 mm

**BREISKY**  
14,0 cm, 5½"  
75-2324-01

82 x 30 mm

76 x 25 mm

**BREISKY**  
14,0 cm, 5½"  
75-2324-02

95 x 38 mm

102 x 44 mm



82 x 30 mm

95 x 38 mm

**BREISKY**  
17,0 cm, 6¾"  
75-2325-03

**BREISKY**  
17,0 cm, 6¾"  
75-2325-04



**Scheidenspekula und -halter**  
**Vaginal Specula and Retractors**  
**Espéculos y valvas vaginales**  
**Speculi e valve vaginali**

**SIMS**  
**GO-1294-00**  
Satz, Set, Juego, Set



**SIMS**  
12,5 cm, 5"  
**75-2325-01**

70 x 35 mm

70 x 30 mm

**SIMS**  
15,0 cm, 6"  
**75-2325-02**

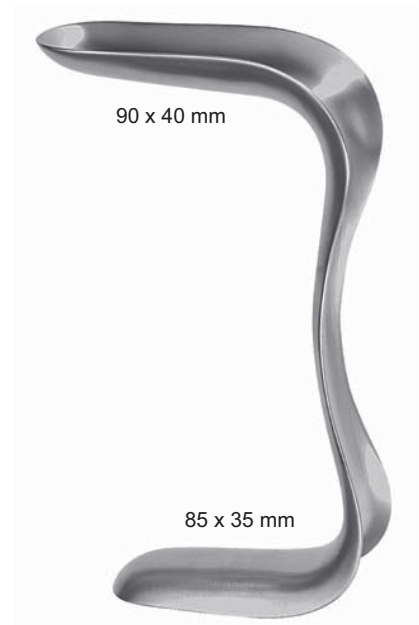

**SIMS**  
17,5 cm, 7"  
**75-2325-03**

Spekula allein  
Specula only  
Espéculos suelto  
Solo speculi

Halter allein  
Retractors only  
Valvas suelto  
Solo valve



**MATHIEU**  
100 x 13-23 mm **75-2326-01**  
100 x 16-30 mm **75-2326-02**

**MATHIEU**  
100 x 11-21 mm **75-2327-01**  
100 x 14-27 mm **75-2327-02**

**LANDAU**  
100 x 28 mm **75-2328-01**  
100 x 38 mm **75-2328-02**

**Scheidenspekula**  
**Vaginal Specula**  
**Espéculos vaginales**  
**Speculi vaginali**



100 x 20 mm	<b>75-2329-20</b>
100 x 25 mm	<b>75-2329-25</b>
100 x 30 mm	<b>75-2329-30</b>
100 x 35 mm	<b>75-2329-35</b>
100 x 40 mm	<b>75-2329-40</b>
<hr/>	
130 x 20 mm	<b>75-2330-20</b>
130 x 25 mm	<b>75-2330-25</b>
130 x 30 mm	<b>75-2330-30</b>
130 x 35 mm	<b>75-2330-35</b>
130 x 40 mm	<b>75-2330-40</b>
<hr/>	
155 x 40 mm	<b>75-2330-40</b>

**BREISKY**



90 x 20 mm	<b>75-2331-20</b>
<hr/>	
100 x 10 mm	<b>75-2331-10</b>
100 x 20 mm	<b>75-2331-20</b>
100 x 25 mm	<b>75-2331-25</b>
<hr/>	
125 x 15 mm	<b>75-2332-15</b>
125 x 20 mm	<b>75-2332-20</b>
125 x 25 mm	<b>75-2332-25</b>
125 x 30 mm	<b>75-2332-30</b>
125 x 35 mm	<b>75-2332-35</b>
125 x 40 mm	<b>75-2332-40</b>

**MATZENAUER**



85 x 17 mm

**BRAUN, MODIF.**  
19,0 cm, 7 1/2"  
**75-2333-19**



60 x 30 mm

**DOYEN**  
23,0 cm, 9"  
**75-2333-23**



80 x 30 mm

**DOYEN**  
25,0 cm, 9"  
**75-2333-25**



95 x 38 mm

**WERTHEIM**  
30,0 cm, 12"  
**75-2333-30**

Endospekula, Lateral-Spekulum, Intrauterinsonde  
Endospecula, Lateral Speculum, Intrauterine Probe  
Endoespéculos, Espéculo lateral, Sonda intra-uterina  
Endospeculi, Speculo lateral, Sonde intrauterine

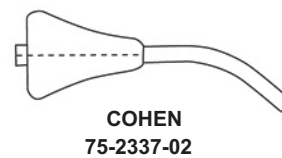
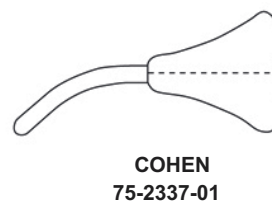
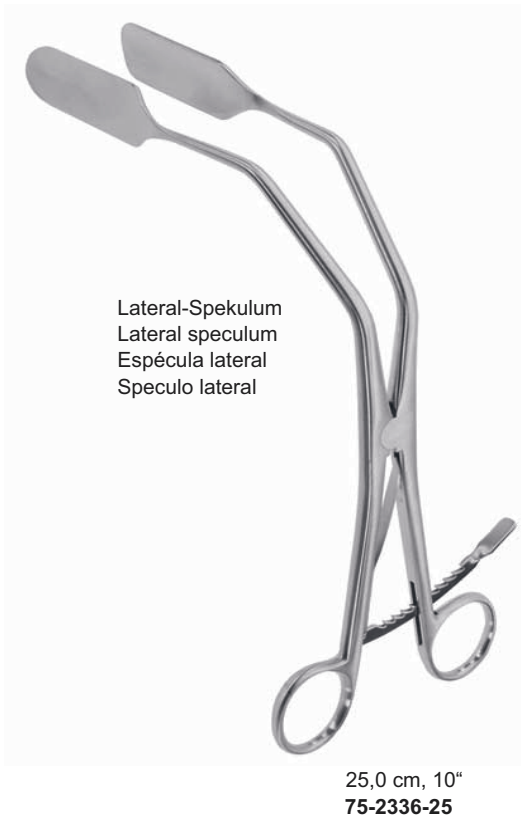
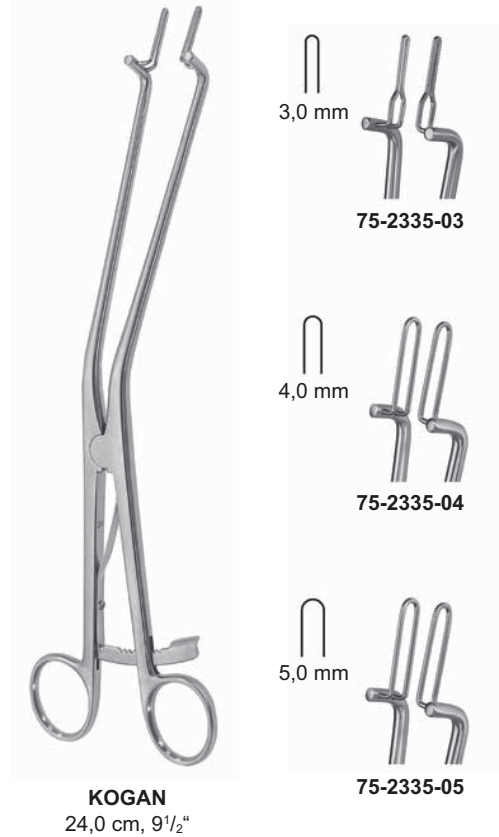

**Uterus-Dilatatoren  
Uterine Dilators  
Dilatadores uterinos  
Dilatatori uterini**



**HEGAR**  
18,5 cm, 7 1/4"

Ø 1,0 mm	<b>75-2338-01</b>
Ø 2,0 mm	<b>75-2338-02</b>
Ø 3,0 mm	<b>75-2338-03</b>
Ø 4,0 mm	<b>75-2338-04</b>
Ø 5,0 mm	<b>75-2338-05</b>
Ø 6,0 mm	<b>75-2338-06</b>
Ø 7,0 mm	<b>75-2338-07</b>
Ø 8,0 mm	<b>75-2338-08</b>
Ø 9,0 mm	<b>75-2338-09</b>
Ø 10,0 mm	<b>75-2338-10</b>
Ø 11,0 mm	<b>75-2338-11</b>
Ø 12,0 mm	<b>75-2338-12</b>
Ø 13,0 mm	<b>75-2338-13</b>
Ø 14,0 mm	<b>75-2338-14</b>
Ø 15,0 mm	<b>75-2338-15</b>
Ø 16,0 mm	<b>75-2338-16</b>
Ø 17,0 mm	<b>75-2338-17</b>
Ø 18,0 mm	<b>75-2338-18</b>
Ø 19,0 mm	<b>75-2338-19</b>
Ø 20,0 mm	<b>75-2338-20</b>
Ø 21,0 mm	<b>75-2338-21</b>
Ø 22,0 mm	<b>75-2338-22</b>
Ø 23,0 mm	<b>75-2338-23</b>
Ø 24,0 mm	<b>75-2338-24</b>
Ø 25,0 mm	<b>75-2338-25</b>
Ø 26,0 mm	<b>75-2338-26</b>



**HEGAR**  
18,5 cm, 7 1/4"

Ø 1,5 mm	<b>75-2339-01</b>
Ø 2,5 mm	<b>75-2339-02</b>
Ø 3,5 mm	<b>75-2339-03</b>
Ø 4,5 mm	<b>75-2339-04</b>
Ø 5,5 mm	<b>75-2339-05</b>
Ø 6,5 mm	<b>75-2339-06</b>
Ø 7,5 mm	<b>75-2339-07</b>
Ø 8,5 mm	<b>75-2339-08</b>
Ø 9,5 mm	<b>75-2339-09</b>
Ø 10,5 mm	<b>75-2339-10</b>
Ø 11,5 mm	<b>75-2339-11</b>
Ø 12,5 mm	<b>75-2339-12</b>
Ø 13,5 mm	<b>75-2339-13</b>
Ø 14,5 mm	<b>75-2339-14</b>
Ø 15,5 mm	<b>75-2339-15</b>
Ø 16,5 mm	<b>75-2339-16</b>
Ø 17,5 mm	<b>75-2339-17</b>



205 x 105 x 45 mm

**HEGAR**  
**75-2340-99**  
Satz, Set, Juego, Set  
Ø 1,0 - Ø 26,0  
(26 dilators)

**HEGAR**  
**75-2340-98**  
Satz, Set, Juego, Set  
Ø 4,0 - Ø 17,0  
(14 dilators)

Uterus-Dilatatoren  
Uterine Dilators  
Dilatadores uterinos  
Dilatatori uterini



**HEGAR**  
20,0 cm, 8"

1,0 / 2,0 mm	<b>75-2341-01</b>
Ø 3,0 / 4,0 mm	<b>75-2341-03</b>
Ø 5,0 / 6,0 mm	<b>75-2341-05</b>
Ø 7,0 / 8,0 mm	<b>75-2341-07</b>
Ø 9,0 / 10,0 mm	<b>75-2341-09</b>
Ø 11,0 / 12,0 mm	<b>75-2341-11</b>
Ø 13,0 / 14,0 mm	<b>75-2341-13</b>
Ø 15,0 / 16,0 mm	<b>75-2341-15</b>
Ø 17,0 / 18,0 mm	<b>75-2341-17</b>
Ø 19,0 / 20,0 mm	<b>75-2341-19</b>
Ø 21,0 / 22,0 mm	<b>75-2341-21</b>
Ø 23,0 / 24,0 mm	<b>75-2341-23</b>
Ø 25,0 / 26,0 mm	<b>75-2341-25</b>



**HEGAR**  
**75-2342-98**  
Satz, Set, Juego, Set  
Ø 3,0 / 4,0 - Ø 17,0 / 18,0 mm  
(8 dilators)

**HEGAR**  
**75-2342-99**  
Satz, Set, Juego, Set  
Ø 1,0 / 2,0 - Ø 25,0 / 26,0 mm  
(13 dilators)



**HANK**

Ø 4,5 / 5,0 mm	<b>75-2344-05</b>
Ø 5,5 / 6,0 mm	<b>75-2344-06</b>
Ø 6,5 / 7,0 mm	<b>75-2344-07</b>
Ø 7,5 / 8,0 mm	<b>75-2344-08</b>
Ø 8,5 / 9,0 mm	<b>75-2344-09</b>
Ø 9,5 / 10,0 mm	<b>75-2344-10</b>

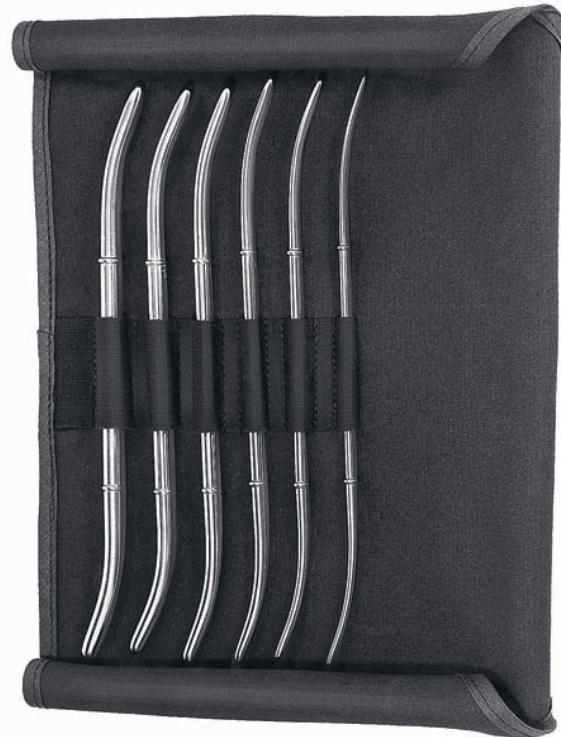

**HANK**  
**75-1345-98**  
Satz, Set, Juego, Set  
Ø 4,5 / 5,0 - Ø 9,5 / 10,0 mm  
(6 dilators)

Uterus-Dilatatoren, Hakenzangen  
 Uterine Dilators, Uterine Tenaculum Forceps  
 Dilatadores uterinos, Pinzas para coger el cuello del útero  
 Dilatatori uterini, Pinze per abbassare il collo dell'utero



**PRATT**

Ø 4,5 / 5,0 mm	<b>75-2346-05</b>
Ø 5,5 / 6,0 mm	<b>75-2346-06</b>
Ø 7,5 / 8,0 mm	<b>75-2346-08</b>
Ø 8,5 / 9,0 mm	<b>75-2346-09</b>
Ø 9,5 / 10,0 mm	<b>75-2346-10</b>
Ø 11,5 / 12,0 mm	<b>75-2346-12</b>
Ø 12,5 / 13,0 mm	<b>75-2346-13</b>
Ø 13,5 / 14,0 mm	<b>75-2346-14</b>



**PRATT**

**75-2347-98**

Satz, Set, Juego, Set  
 Ø 4,5 / 5,0 - Ø 13,5 / 14,0 mm  
 (8 dilators)



**BARRETT**  
 18,0 cm, 7"  
**75-2348-18**

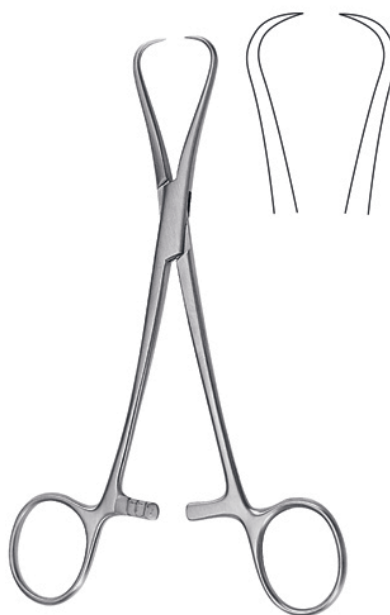

**ADAIR**  
 19,0 cm, 7½"  
**75-2349-19**



**STAUDE-MOORE**  
 17,0 cm, 6¾"  
**75-2350-17**

**Hakenzangen**  
**Uterine Tenaculum Forceps**  
**Pinzas para coger el cuello del útero**  
**Pinze per abbassare il collo dell'utero**

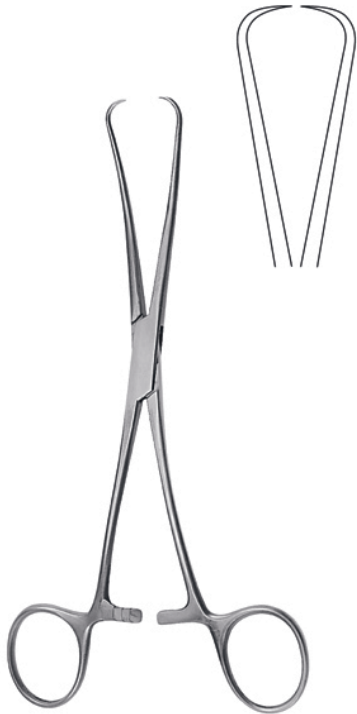

**JARCHO**  
20,0 cm, 8"  
75-2351-20



**SCHROEDER**  
25,0 cm, 9<sup>3</sup>/<sub>4</sub>"  
75-2352-25



**BRAUN**  
25,0 cm, 9<sup>3</sup>/<sub>4</sub>"  
75-2353-25



**DUPLAY**  
28,0 cm, 11"  
75-2354-28



**POZZI**  
26,0 cm, 10<sup>1</sup>/<sub>4</sub>"  
75-2355-26



**KAHN**  
24,0 cm, 9<sup>1</sup>/<sub>2</sub>"  
75-2356-24

**Hakenzangen**  
**Uterine Tenaculum Forceps**  
**Pinzas para coger el cuello del útero**  
**Pinze per abbassare il collo dell'utero**



**SKENE**  
24,0 cm, 9½"  
75-2357-24



**SCHROEDER**  
24,0 cm, 9½"  
75-2358-24



**SCHROEDER**  
24,0 cm, 9½"  
75-2359-24



**TEALE**  
23,0 cm, 9"  
75-2360-23



**JACOBS**  
21,0 cm, 8½"  
75-2361-21



**JACOBS**  
21,0 cm, 8½"  
75-2362-21



**Hakenzangen**  
**Uterine Tenaculum Forceps**  
**Pinzas para coger el cuello del útero**  
**Pinze per abbassare il collo dell'utero**

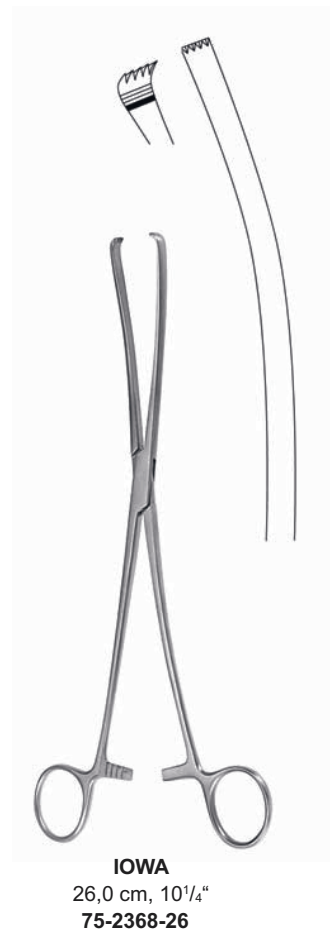
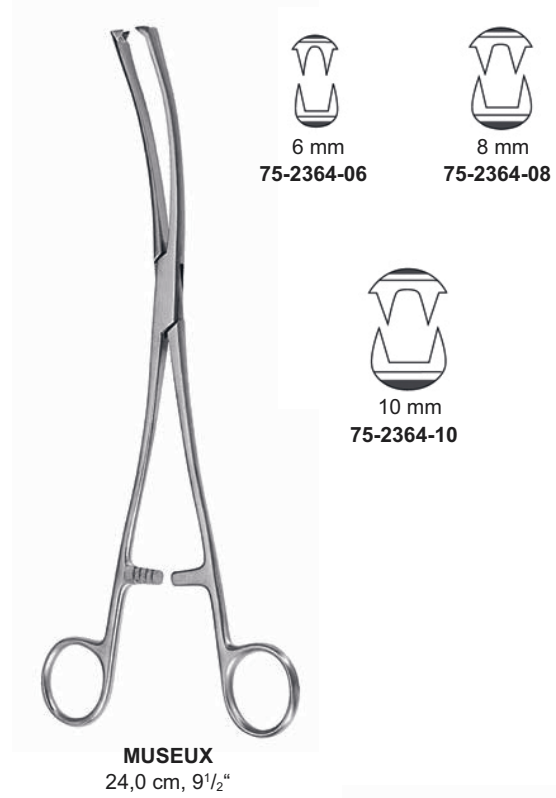
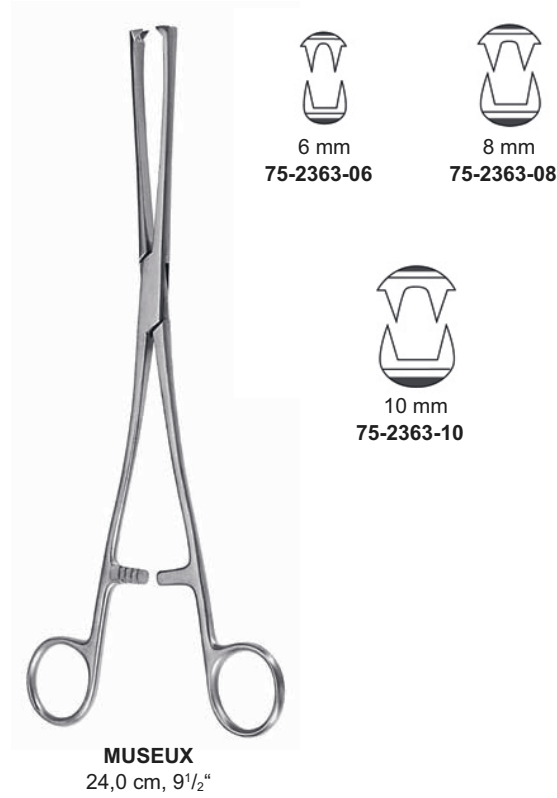

Polypen- und Ovarienzangen, Uterusfaßzangen  
 Polypus and Ovum Forceps, Uterine Elevating Forceps  
 Pinzas para pólipos uterinos y ovarios, Pinzas para la útero  
 Pinze per polipi e ovaie, Pinze per affarrare l'utero



**DOYEN**  
20,5 cm, 8"  
75-2369-20

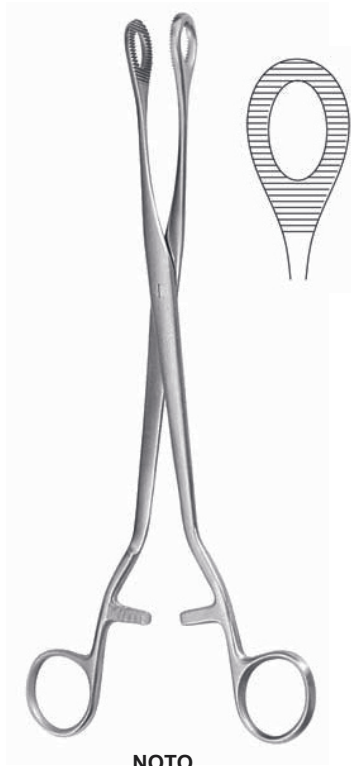

**NOTO**  
27,0 cm, 10<sup>5</sup>/<sub>8</sub>"  
75-2370-27

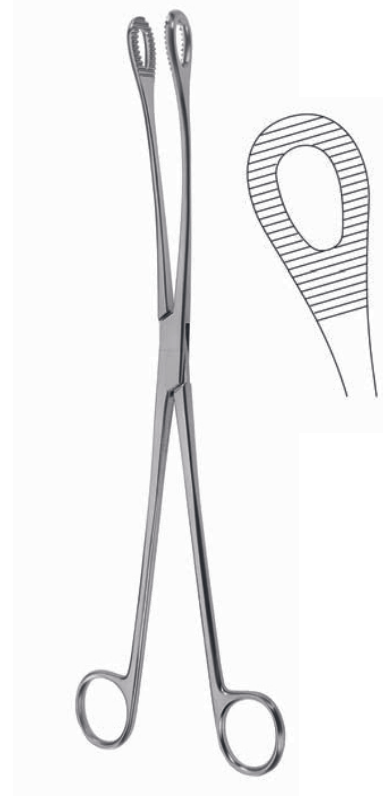

**KELLY**  
32,0 cm, 12<sup>1</sup>/<sub>2</sub>"  
75-2371-32



**HEYWOOD-SMITH**  
25,0 cm, 9<sup>3</sup>/<sub>4</sub>"  
75-2372-25



**DARTIGUES**  
27,0 cm, 10<sup>3</sup>/<sub>4</sub>"  
75-2373-27



**SOMER**  
23,0 cm, 9"  
75-2374-23

Uterusfaßzangen, Uterussonden, Zentimetereinteilung  
 Uterine Elevating Forceps, Uterine Probes, graduated in centimeters  
 Pinzas para la útero, Histerómetros, graduado en centímetros  
 Pinze per affarrare l'utero, Isterometri, graduato in cm



**COLLIN**  
25,0 cm, 9<sup>3</sup>/<sub>4</sub>"  
75-2375-25



**BEACHAM**  
26,0 cm, 10<sup>1</sup>/<sub>4</sub>"  
75-2376-26

Amniotom  
Amniotome  
Amniótomo  
Amniotomo



**BRAUN**  
28,0 cm, 11"  
75-2377-28

Uterus-Depressor  
Uterine depressor  
Depresor uterino  
Depressori uterini



**SIMS**  
32,0 cm, 12<sup>1</sup>/<sub>2</sub>"  
75-2378-32

biegsam  
malleable  
maleable  
malleabile



**SIMS**  
32,0 cm, 12<sup>1</sup>/<sub>2</sub>"  
75-2379-32



**MARTIN**  
32,0 cm, 12<sup>1</sup>/<sub>2</sub>"  
75-2380-32



**MARTIN**  
32,0 cm, 12<sup>1</sup>/<sub>2</sub>"  
75-2381-32

biegsam  
malleable  
maleable  
malleabile



**VALLEIX**  
25,0 cm, 10"  
75-2382-25

Ø 4 mm



**SIMPSON**  
29,0 cm, 11<sup>1</sup>/<sub>2</sub>"  
75-2383-29

biegsam  
malleable  
maleable  
malleabile

Ø 4 mm



**COLLIN**  
28,0 cm, 11"  
75-2384-28

**Biopsieküretten**  
**Biopsy Curettes**  
**Curetas para biopsia**  
**Curette per biopsia**



**KEVORKIAN**  
30,0 cm, 12"  
75-2385-30



**KEVORKIAN**  
30,0 cm, 12"  
75-2386-30



**KEVORKIAN**  
30,0 cm, 12"  
75-2387-30

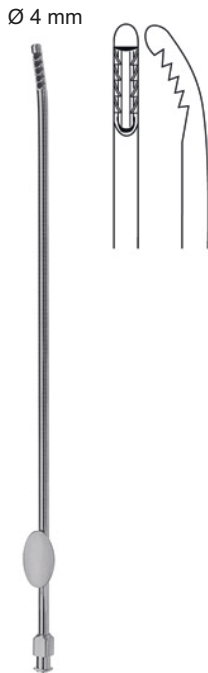

**NOVAK**  
23,0 cm, 9"  
75-2391-04

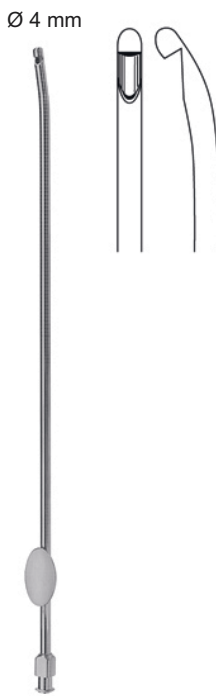

**RANDALL**  
23,0 cm, 9"  
75-2392-04



**MILAN**  
29,0 cm, 11½"

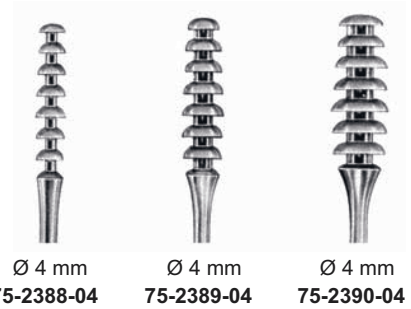

**Myominstrumente**  
**Myoma Instruments**  
**Instrumentos para mioma**  
**Strumenti per fibroma**



**UTERUSPERFORATOR**  
25,0 cm, 9<sup>3</sup>/<sub>4</sub>"  
75-2393-25



**FISTELHAKEN**  
25,0 cm, 9<sup>3</sup>/<sub>4</sub>"  
75-2394-25



**SIMON**  
22,0 cm, 8<sup>5</sup>/<sub>8</sub>"  
75-2395-22



**EMMETT**  
22,0 cm, 8<sup>5</sup>/<sub>8</sub>"



75-2396-01



75-2396-02



75-2396-03



75-2396-04



75-2396-05



**SEGOND**  
27,0 cm, 10<sup>5</sup>/<sub>8</sub>"  
75-2397-27



**AYRE**  
23,0 cm, 9"  
75-2397-23

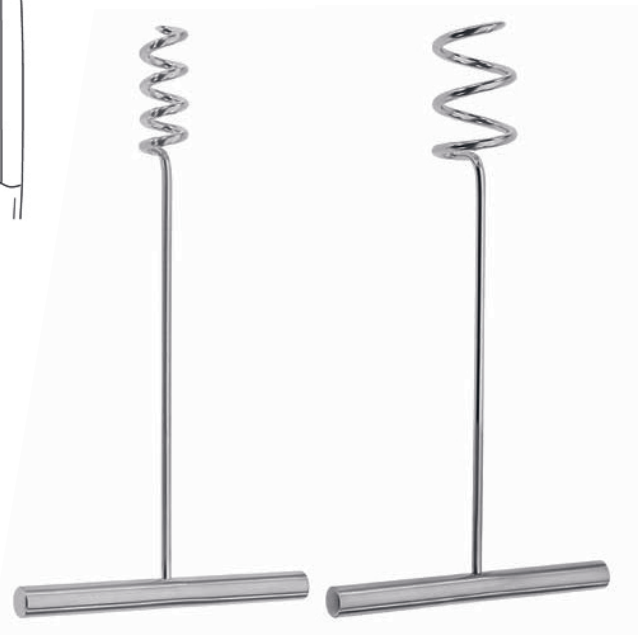
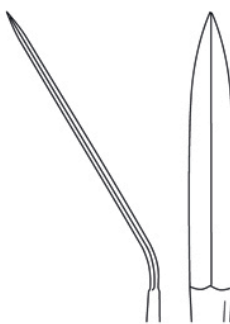

**DOYEN**  
19,0 cm, 7<sup>1</sup>/<sub>2</sub>"  
75-2397-01

**DOYEN**  
17,0 cm, 6<sup>3</sup>/<sub>4</sub>"  
75-2397-02

**Uterusküretten**  
**Uterine Curettes**  
**Curetas uterinas**  
**Curette uterine**

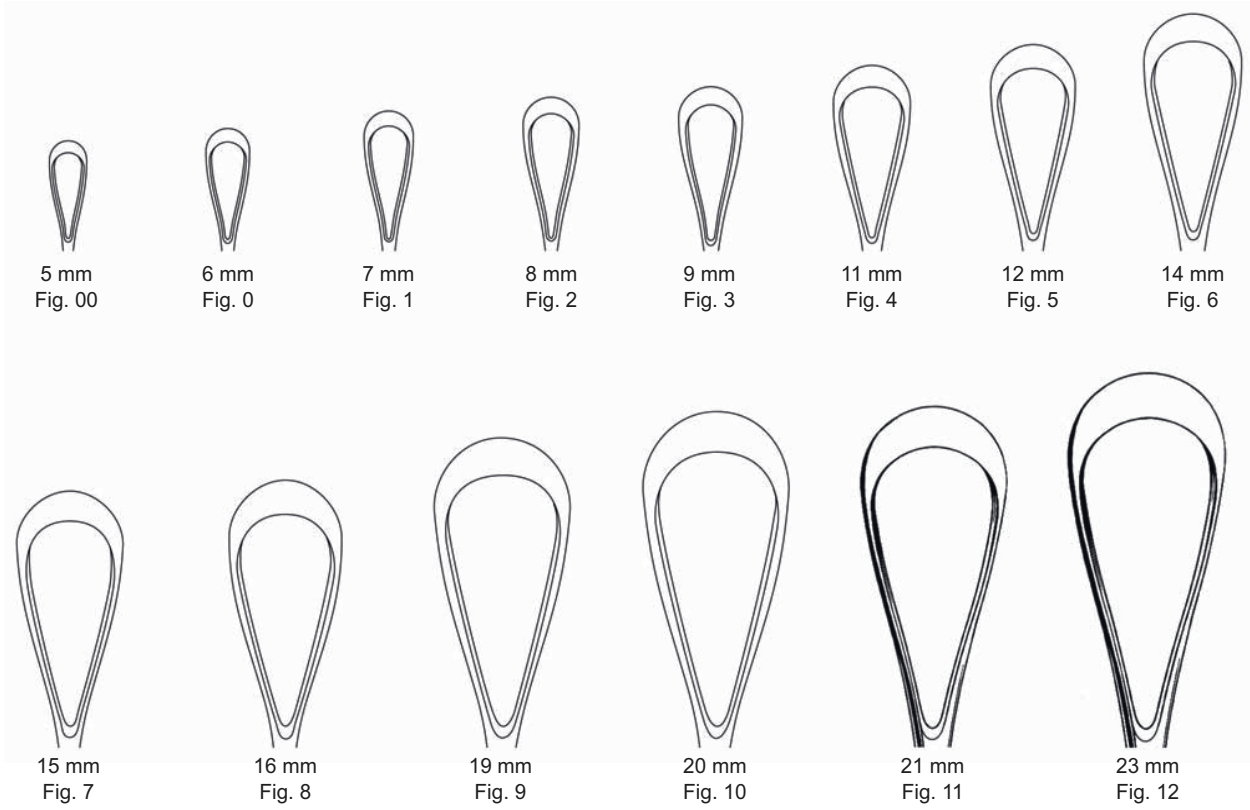

scharf, fest  
 sharp, rigid  
 cortantes, rígidas  
 acute, rigide

Fig. 00	75-2398-05
Fig. 0	75-2398-06
Fig. 1	75-2398-07
Fig. 2	75-2398-08
Fig. 3	75-2398-09
Fig. 4	75-2398-11
Fig. 5	75-2398-12
Fig. 6	75-2398-14
Fig. 7	75-2398-15
Fig. 8	75-2398-16
Fig. 9	75-2398-19
Fig. 10	75-2398-20
Fig. 11	75-2398-21
Fig. 12	75-2398-23

**RECAMIER**  
 26,0 cm, 10<sup>1</sup>/<sub>4</sub>"



scharf, biegsam  
 sharp, malleable  
 cortantes, maleable  
 acute, malleabile

Fig. 00	75-2399-05
Fig. 0	75-2399-06
Fig. 1	75-2399-07
Fig. 2	75-2399-08
Fig. 3	75-2399-09
Fig. 4	75-2399-11
Fig. 5	75-2399-12
Fig. 6	75-2399-14
Fig. 7	75-2399-15
Fig. 8	75-2399-16
Fig. 9	75-2399-19
Fig. 10	75-2399-20
Fig. 11	75-2399-21
Fig. 12	75-2399-23

**RECAMIER**  
 26,0 cm, 10<sup>1</sup>/<sub>4</sub>"

Uterusküretten  
Uterine Curettes  
Curetas uterinas  
Curette uterine

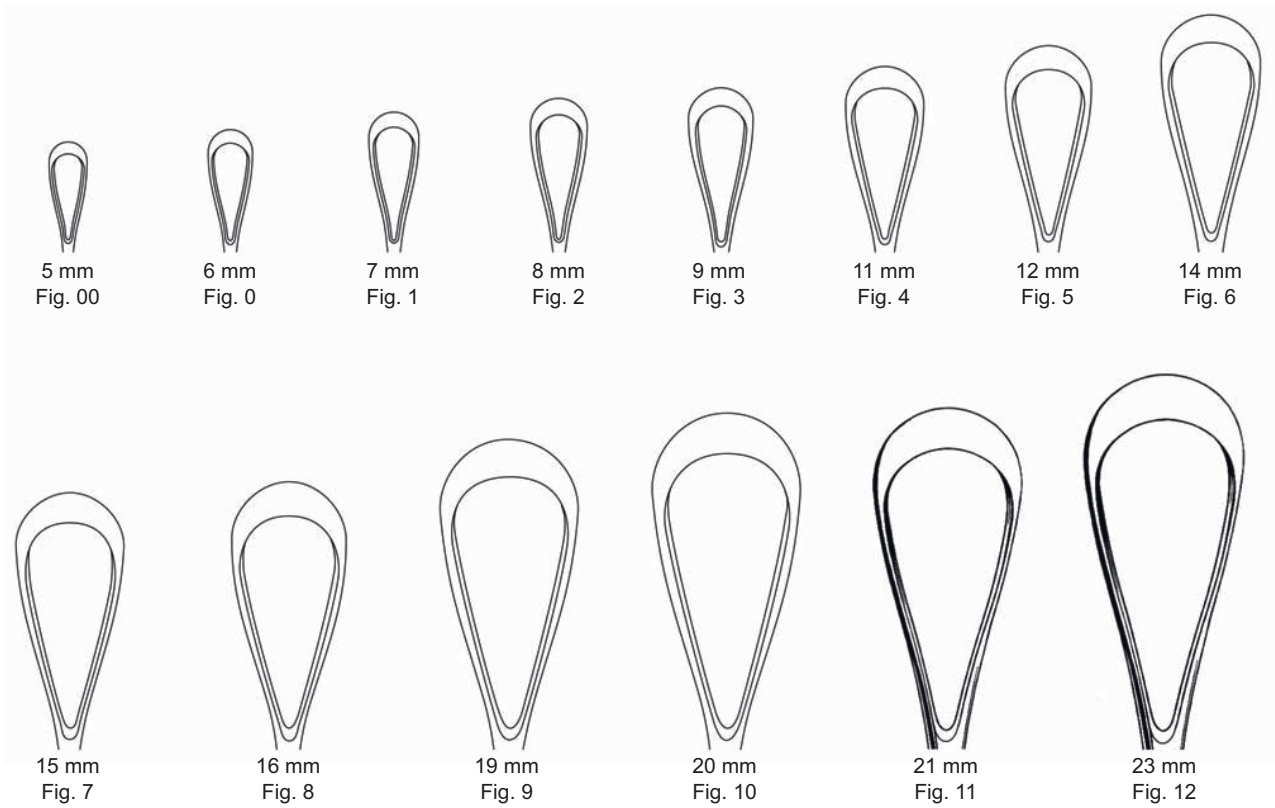

scharf, fest  
sharp, rigid  
cortantes, rigidas  
acute, rigide

Fig. 00	75-2400-05
Fig. 0	75-2400-06
Fig. 1	75-2400-07
Fig. 2	75-2400-08
Fig. 3	75-2400-09
Fig. 4	75-2400-11
Fig. 5	75-2400-12
Fig. 6	75-2400-14
Fig. 7	75-2400-15
Fig. 8	75-2400-16
Fig. 9	75-2400-19
Fig. 10	75-2400-20
Fig. 11	75-2400-21
Fig. 12	75-2400-23

**SIMS**  
26,0 cm, 10<sup>1</sup>/<sub>4</sub>"



scharf, biegsam  
sharp, malleable  
cortantes, maleable  
acute, malleabile

Fig. 00	75-2401-05
Fig. 0	75-2401-06
Fig. 1	75-2401-07
Fig. 2	75-2401-08
Fig. 3	75-2401-09
Fig. 4	75-2401-11
Fig. 5	75-2401-12
Fig. 6	75-2401-14
Fig. 7	75-2401-15
Fig. 8	75-2401-16
Fig. 9	75-2401-19
Fig. 10	75-2401-20
Fig. 11	75-2401-21
Fig. 12	75-2401-23

**SIMS**  
26,0 cm, 10<sup>1</sup>/<sub>4</sub>"

**Uterusküretten**  
**Uterine Curettes**  
**Curetas uterinas**  
**Curette uterine**

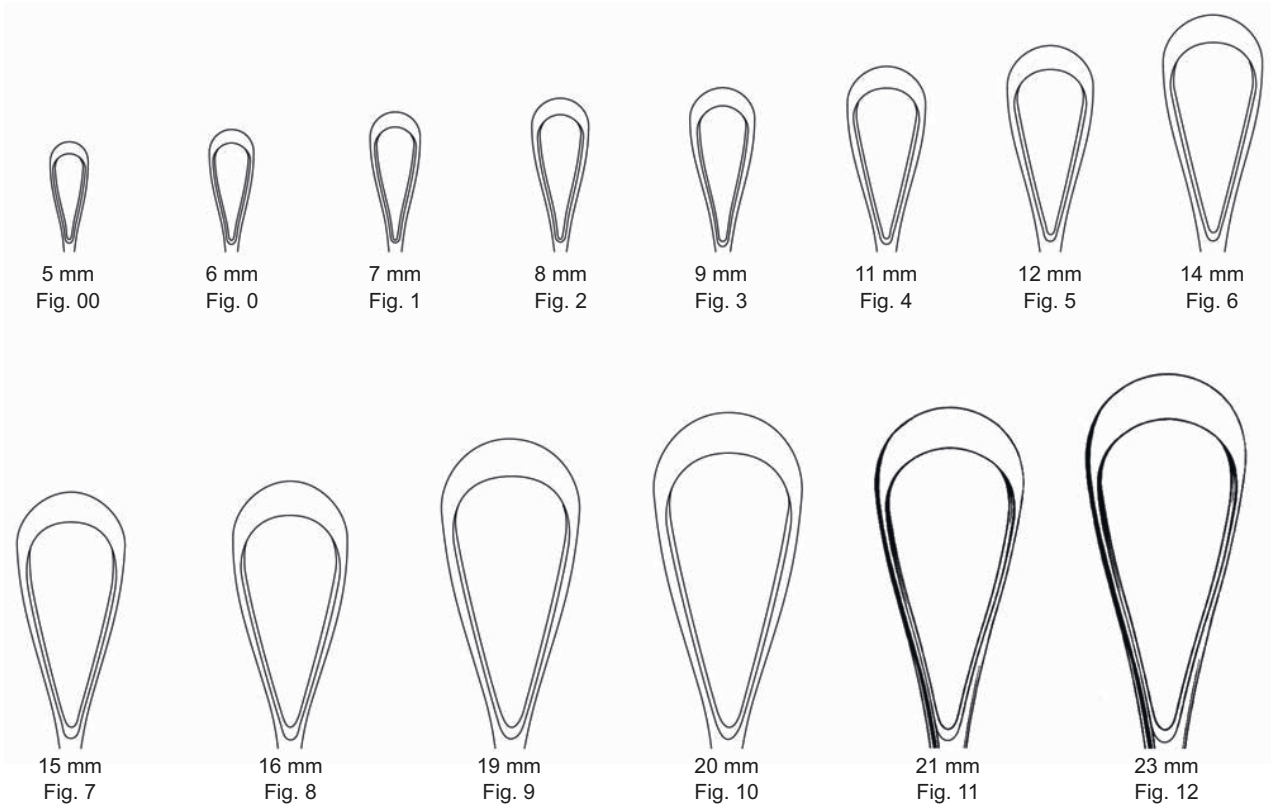

scharf, fest  
 sharp, rigid  
 cortantes, rígidas  
 acute, rigide

Fig. 00	75-2402-05
Fig. 0	75-2402-06
Fig. 1	75-2402-07
Fig. 2	75-2402-08
Fig. 3	75-2402-09
Fig. 4	75-2402-11
Fig. 5	75-2402-12
Fig. 6	75-2402-14
Fig. 7	75-2402-15
Fig. 8	75-2402-16
Fig. 9	75-2402-19
Fig. 10	75-2402-20
Fig. 11	75-2402-21
Fig. 12	75-2402-23

**RECAMIER**  
 31,0 cm, 12<sup>1</sup>/<sub>4</sub>"



scharf, biegsam  
 sharp, malleable  
 cortantes, maleable  
 acute, malleabile

Fig. 00	75-2403-05
Fig. 0	75-2403-06
Fig. 1	75-2403-07
Fig. 2	75-2403-08
Fig. 3	75-2403-09
Fig. 4	75-2403-11
Fig. 5	75-2403-12
Fig. 6	75-2403-14
Fig. 7	75-2403-15
Fig. 8	75-2403-16
Fig. 9	75-2403-19
Fig. 10	75-2403-20
Fig. 11	75-2403-21
Fig. 12	75-2403-23

**RECAMIER**  
 31,0 cm, 12<sup>1</sup>/<sub>4</sub>"



Uterusküretten  
Uterine Curettes  
Curetas uterinas  
Curette uterine

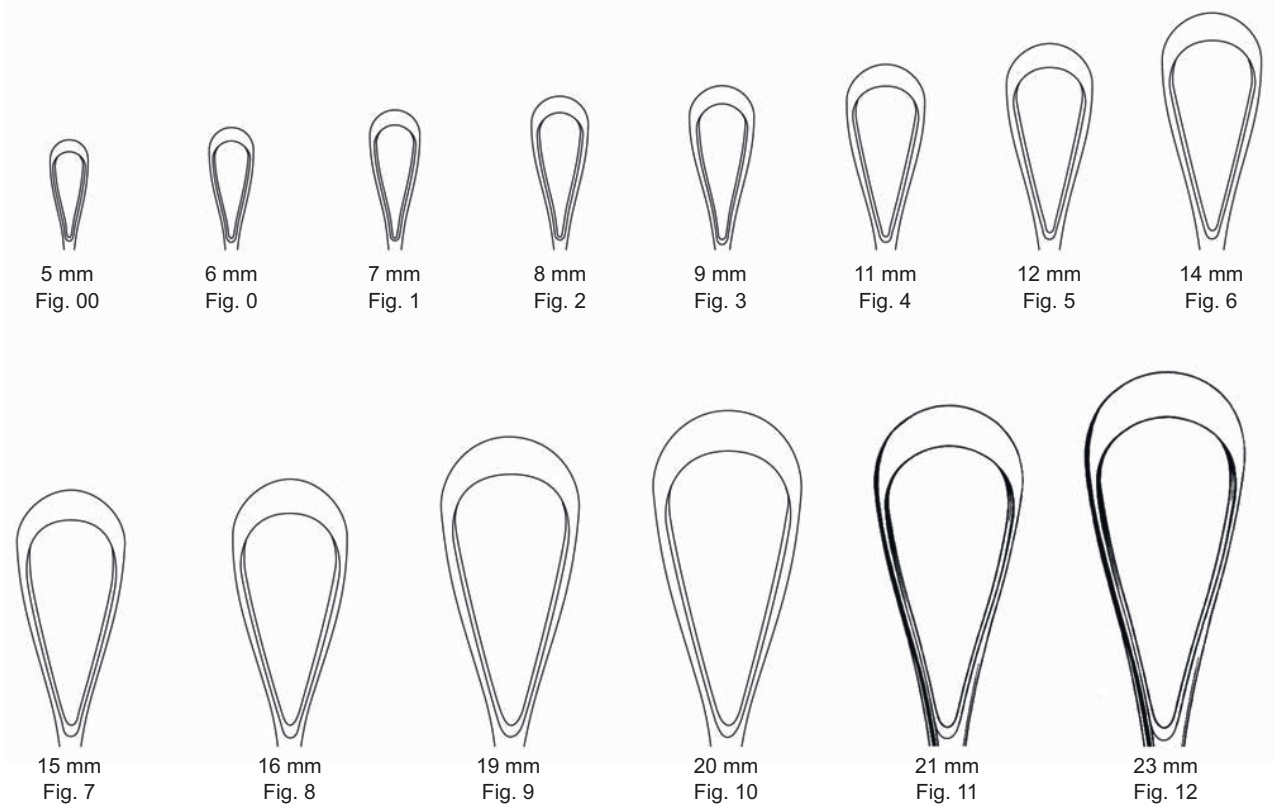

scharf, fest  
sharp, rigid  
cortantes, rígidas  
acute, rigide

Fig. 00	75-2404-05
Fig. 0	75-2404-06
Fig. 1	75-2404-07
Fig. 2	75-2404-08
Fig. 3	75-2404-09
Fig. 4	75-2404-11
Fig. 5	75-2404-12
Fig. 6	75-2404-14
Fig. 7	75-2404-15
Fig. 8	75-2404-16
Fig. 9	75-2404-19
Fig. 10	75-2404-20
Fig. 11	75-2404-21
Fig. 12	75-2404-23

**SIMS**  
31,0 cm, 12<sup>1</sup>/<sub>4</sub>"



scharf, biegsam  
sharp, malleable  
cortantes, maleable  
acute, malleabile

Fig. 00	75-2405-05
Fig. 0	75-2405-06
Fig. 1	75-2405-07
Fig. 2	75-2405-08
Fig. 3	75-2405-09
Fig. 4	75-2405-11
Fig. 5	75-2405-12
Fig. 6	75-2405-14
Fig. 7	75-2405-15
Fig. 8	75-2405-16
Fig. 9	75-2405-19
Fig. 10	75-2405-20
Fig. 11	75-2405-21
Fig. 12	75-2405-23

**SIMS**  
31,0 cm, 12<sup>1</sup>/<sub>4</sub>"

Uterusküretten  
 Uterine Curettes  
 Curetas uterinas  
 Curette uterine

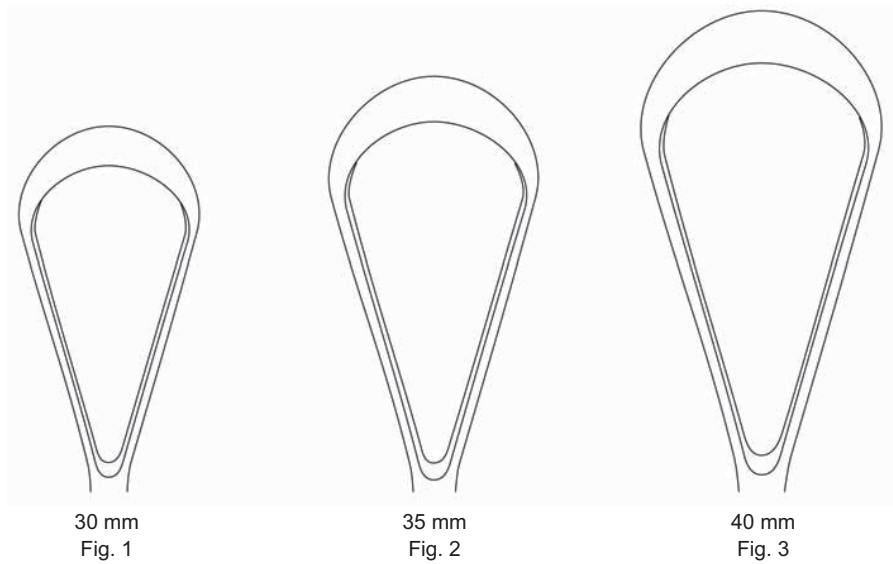

scharf, fest  
 sharp, rigid  
 cortantes, rígidas  
 acute, rigide

Fig. 1	<b>75-2406-30</b>
Fig. 2	<b>75-2406-35</b>
Fig. 3	<b>75-2406-40</b>

**SIMS**  
 31,0 cm, 12<sup>1</sup>/<sub>4</sub>"



scharf, biegsam  
 sharp, malleable  
 cortantes, maleable  
 acute, malleabile

Fig. 1	<b>75-2407-30</b>
Fig. 2	<b>75-2407-35</b>
Fig. 3	<b>75-2407-40</b>

**SIMS**  
 31,0 cm, 12<sup>1</sup>/<sub>4</sub>"

Uterusküretten  
Uterine Curettes  
Curetas uterinas  
Curette uterine

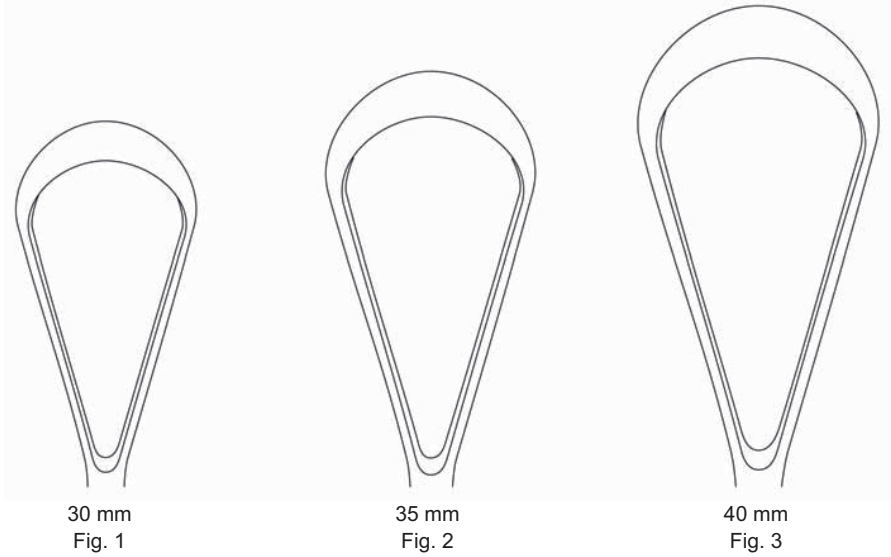

scharf, fest  
sharp, rigid  
cortantes, rígidas  
acute, rigide

Fig. 1	<b>75-2408-30</b>
Fig. 2	<b>75-2408-35</b>
Fig. 3	<b>75-2408-40</b>

**BUMM**  
31,0 cm, 12 1/4"



scharf, biegsam  
sharp, malleable  
cortantes, maleable  
acute, malleabile

Fig. 1	<b>75-2409-30</b>
Fig. 2	<b>75-2409-35</b>
Fig. 3	<b>75-2409-40</b>

**BUMM**  
31,0 cm, 12 1/4"

**Uteruslöffel, Uterus-Biopsiezangen**  
**Uterine Scoopes, Cervical Biopsy and Specimen Forceps**  
**Cucharillas uterinas, Pinzas saca-bocados para biopsia**  
**Curette uterine, Pinze per la biopsia cervicale e da prelievo**

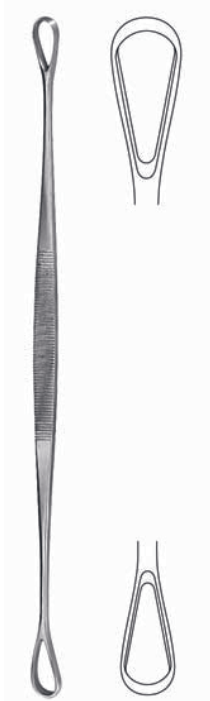

**BLAKE**  
27,0 cm, 10<sup>5</sup>/<sub>8</sub>"  
75-1750-27



**SIMON**  
25,0 cm, 9<sup>3</sup>/<sub>4</sub>"

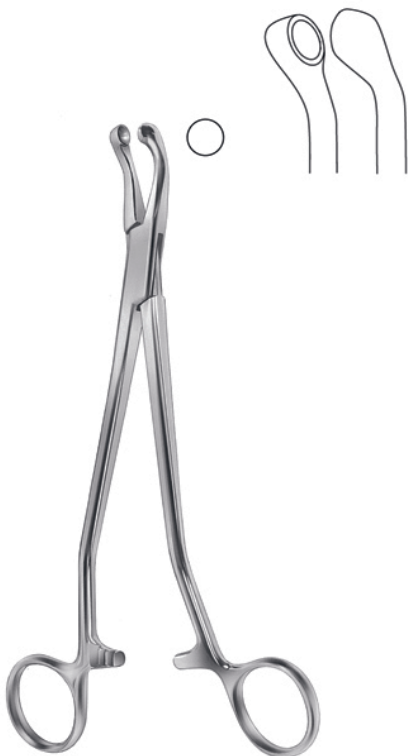
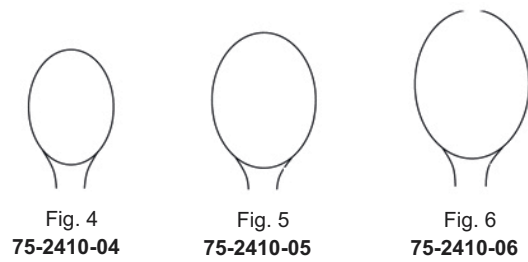
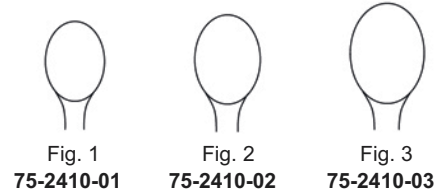

**THOMS-GAYLOR**  
22,0 cm, 8<sup>5</sup>/<sub>8</sub>" 75-2412-22  
24,0 cm, 9<sup>1</sup>/<sub>2</sub>" 75-2412-24



29,0 cm, 11<sup>1</sup>/<sub>2</sub>" 75-2413-29



**SCHUMACHER-VAN DOREN**  
24,0 cm, 9<sup>1</sup>/<sub>2</sub>"  
75-2414-24

**Uterus-Biopsiezangen**  
**Cervical Biopsy and Specimen Forceps**  
**Pinzas saca-bocados para biopsia**  
**Pinze per la biopsia cervicale e da prelievo**



**THOMS-GAYLOR**  
24,0 cm, 9½"  
75-2415-24



**FAURE**  
21,0 cm, 8¼"  
75-2416-21



**SCHUBERT**  
26,0 cm, 10¼"  
75-2417-26

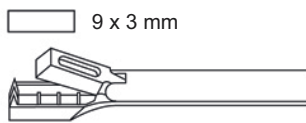
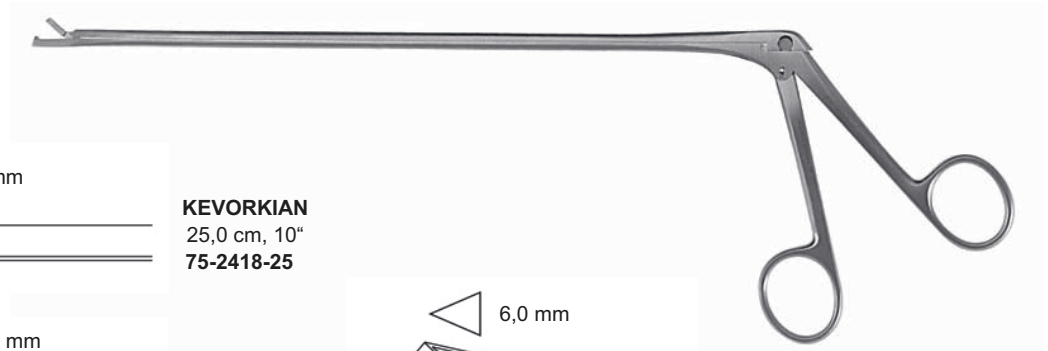

**KEVORKIAN**  
25,0 cm, 10"  
75-2418-25

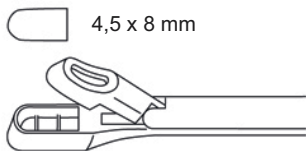

**EPPENDORFER**  
20,0 cm, 8"  
75-2419-20

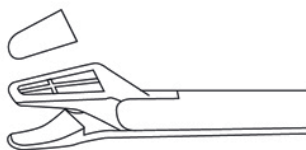

**ALEXANDER**  
28,0 cm, 11"  
75-2420-28

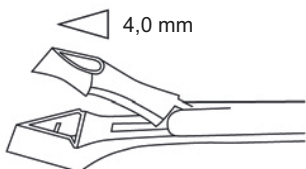

**SCHUMACHER**  
24,0 cm, 9½"  
75-2421-04

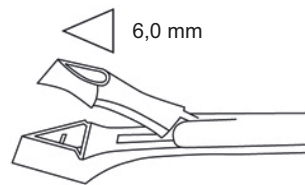

**SCHUMACHER**  
24,0 cm, 9½"  
75-2422-06

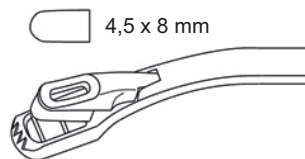

**WITTNER**  
23,0 cm, 9"  
75-2423-23

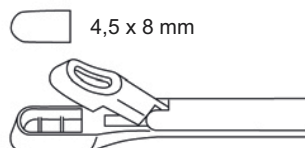

**WITTNER**  
23,0 cm, 9"  
75-2424-23

Uterus-Biopsiezangen  
 Cervical Biopsy and Specimen Forceps  
 Pinzas saca-bocados para biopsia  
 Pinze per la biopsia cervicale e da prelievo

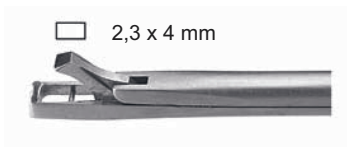
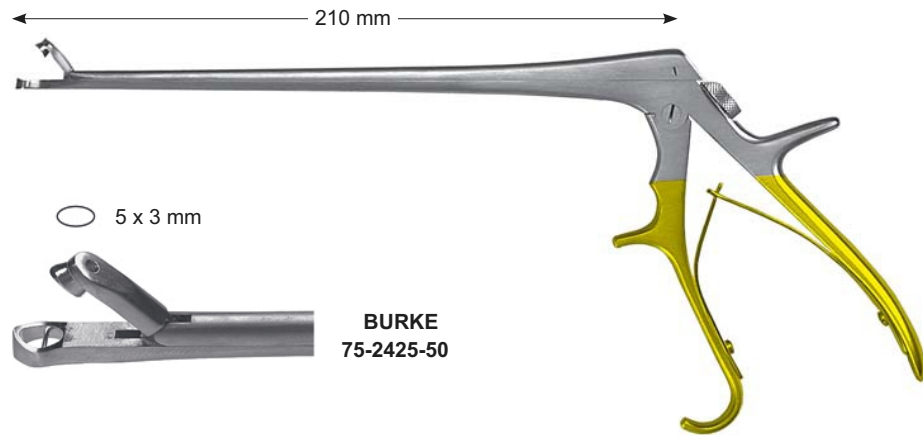

Geburtszangen  
Obstetrical Forceps  
Fórceps para obstétrica  
Forbici per ostetricia



**WRIGLEY**  
28,0 cm, 11"  
75-2431-28



**SIMPSON**  
30,0 cm, 11<sup>3</sup>/<sub>4</sub>"  
75-2432-30



**SIMPSON-BRAUN**  
33,0 cm, 13"  
75-2433-33



**SIMPSON-BRAUN**  
36,0 cm, 14<sup>1</sup>/<sub>8</sub>"  
75-2434-36



**SIMPSON-LUIKART**  
36,0 cm, 14<sup>1</sup>/<sub>8</sub>"  
75-2435-36



**DE LEE**  
30,0 cm, 11<sup>3</sup>/<sub>4</sub>"  
75-2436-30



**DE LEE**  
36,0 cm, 14<sup>1</sup>/<sub>8</sub>"  
75-2437-36



**DE LEE**  
38,0 cm, 15<sup>3</sup>/<sub>8</sub>"  
75-2438-38

# Surgical Catalogue

Geburtszangen  
Obstetrical Forceps  
Fórceps para obstétrica  
Forbici per ostetricia



**MC LEAN**  
36,0 cm, 14<sup>1</sup>/<sub>8</sub>"  
75-2439-36



**KIELAND**  
41,0 cm, 16"  
75-2440-41



**KIELAND-LUIKART**  
40,0 cm, 15<sup>3</sup>/<sub>4</sub>"  
75-2441-40



**PIPER**  
44,0 cm, 17<sup>1</sup>/<sub>4</sub>"  
75-2442-44



**ELLIOT**  
32,0 cm, 12<sup>1</sup>/<sub>2</sub>"  
75-2443-32



**ELLIOT**  
38,0 cm, 15"  
75-2444-38



**NAEGELE**  
36,0 cm, 14<sup>1</sup>/<sub>8</sub>"  
75-2445-36



**NAEGELE**  
40,0 cm, 15<sup>3</sup>/<sub>4</sub>"  
75-2446-40



Geburtszangen, Plazentar- und Abortuszangen  
 Obstetrical Forceps, Placenta and Ovum Forceps  
 Fórceps para obstétrica, Pinzas para aborto y placenta  
 Forbici per ostetricia, Pinze per placenta e per ovaie



**GREEN-ARMYTAGE**  
 21,0 cm, 8<sup>1</sup>/<sub>4</sub>"  
 75-2447-21

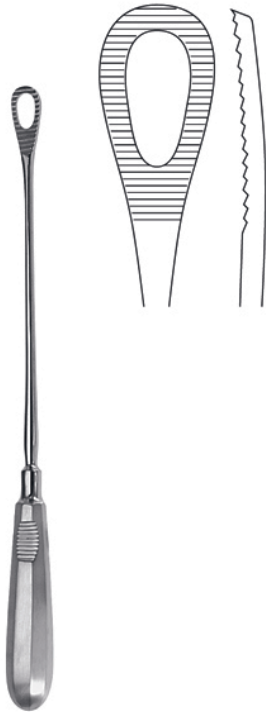

**PESTALOZZA**  
 30,0 cm, 11<sup>3</sup>/<sub>4</sub>"  
 75-2448-30



**SAENGER**  
 27,0 cm, 10<sup>5</sup>/<sub>8</sub>"  
 75-2249-27



**SAENGER**  
 27,0 cm, 10<sup>5</sup>/<sub>8</sub>"  
 75-2450-27



**WINTER**  
 28,0 cm, 11"



Fig. 1  
 75-2451-01



Fig. 2  
 75-2451-02



Fig. 3  
 75-2451-03



Fig. 1  
 75-2452-01

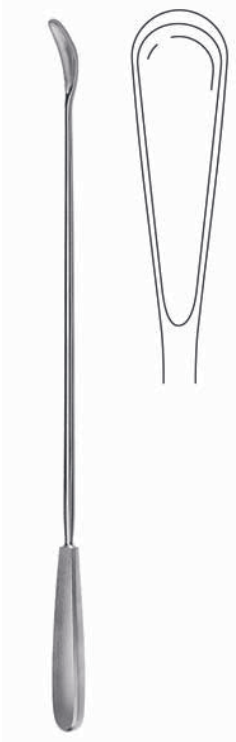

Fig. 2  
 75-2452-02



Fig. 3  
 75-2452-03

Plazentar- und Abortuszangen  
Placenta and Ovum Forceps  
Pinzas para aborto y placenta  
Pinze per placenta e per ovaie



**WALLICH**  
42,0 cm, 16½"  
75-2453-42



**MARTIN**  
34,0 cm, 13¾"  
75-2454-34



**BIERER**  
33,0 cm, 13"  
75-2455-01



**BIERER**  
33,0 cm, 13"  
75-2456-02



**BIERER**  
33,0 cm, 13"  
75-2457-01



**BIERER**  
33,0 cm, 13"  
75-2458-02



**Vorbereitung, Dermatologie**

**Preparation, Dermatology**

**Preparación, Dermatología**

**Preparazione, Dermatalogia**

Hautstanzen, Nagel Instrumente  
 Dermal Punches, Nail Instruments  
 Trépanos cutáneos, Instrumentos para uñas  
 Trapani dermatici, Strumenti per unghie



Lupusküretten  
 Lupus curettes  
 Curetas para lupus  
 Raschiatoio per lupus

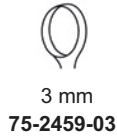

**PIFFARD**  
 14,0 cm, 5<sup>3</sup>/<sub>4</sub>"

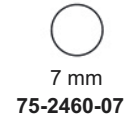
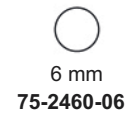
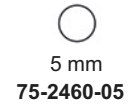
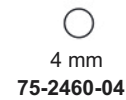
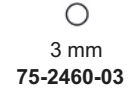
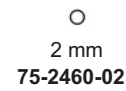

**KEYES**  
 12,0 cm, 4<sup>3</sup>/<sub>4</sub>"



**KEYES**  
 12,0 cm, 4<sup>3</sup>/<sub>4</sub>"  
**75-2461-00**

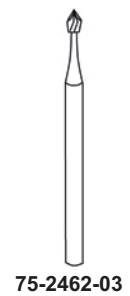
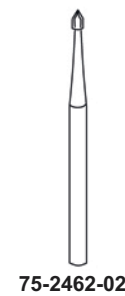
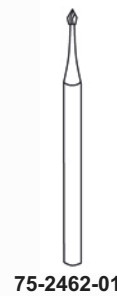
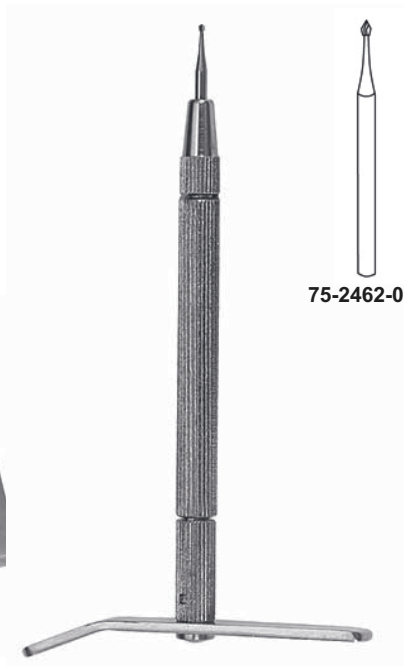

**NAGELBOHRER**  
**75-2462-00**  
 komplett, complete,  
 completo, completo

**Komedonenquetscher  
Comedo Extractors  
Saca-comedones  
Tiracomedoni**



**UNNA**  
14,0 cm, 5<sup>3</sup>/<sub>4</sub>"  
75-2463-14



**UNNA**  
14,0 cm, 5<sup>3</sup>/<sub>4</sub>"  
75-2464-14



**SAALFELD**  
10,0 cm, 4"  
75-2465-10



**SAALFELD**  
14,0 cm, 5<sup>3</sup>/<sub>4</sub>"  
75-2466-14



**SCHAMBERG**  
10,0 cm, 4"  
75-2467-10



**WALTON**  
14,0 cm, 5<sup>3</sup>/<sub>4</sub>"  
75-2468-14



**FOX**  
14,0 cm, 5<sup>3</sup>/<sub>4</sub>"



3 mm  
75-2469-03

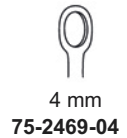

4 mm  
75-2469-04



5 mm  
75-2469-05



6 mm  
75-2469-06

**Lupusküretten  
Lupus curettes  
Curetas para lupus  
Raschiatoio per lupus**

**Nagel Instrumente**  
**Nail Instruments**  
**Instrumentos para uñas**  
**Strumenti per unghie**



059-1420-01

**FINGERRINGSÄGE**  
17,0 cm, 6<sup>3</sup>/<sub>4</sub>"  
75-2470-17



059-1430-01

**WALTON**  
16,0 cm, 6<sup>1</sup>/<sub>4</sub>"  
75-2471-16



**RADOLF**  
13,5 cm, 5<sup>3</sup>/<sub>8</sub>"  
75-2472-13



**NAGELZANGE**  
13,5 cm, 5<sup>3</sup>/<sub>8</sub>"  
75-2473-13



**NAGELZANGE**  
13,0 cm, 5"  
75-2474-13



**NAGELZANGE**  
14,0 cm, 5<sup>1</sup>/<sub>2</sub>"

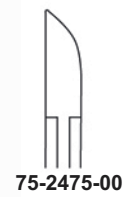

75-2475-00

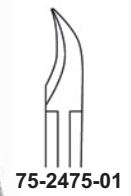

75-2475-01

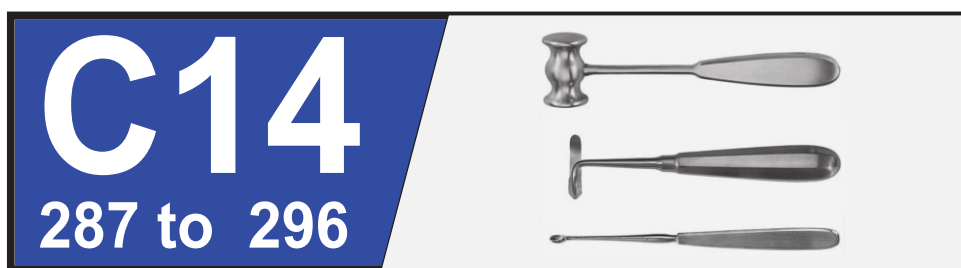































**Knochenchirurgie**

**Bone Surgery**

**Cirurgía ósea**

**Chirurgia ossea**

**Scharfe Löffel**  
**Bone Curettes**  
**Cucharillas cortantes**  
**Curetta per ossa**

		
	Fig. 0000 75-2477-04	Fig. 0000 75-2478-04
		
	Fig. 000 75-2477-03	Fig. 000 75-2478-03
		
Fig. 000 75-2476-03	Fig. 00 75-2477-02	Fig. 00 75-2478-02
		
Fig. 00 75-2476-02	Fig. 0 75-2477-01	Fig. 0 75-2478-01
		
Fig. 0 75-2476-01	Fig. 1 75-2477-11	Fig. 1 75-2478-11
		
Fig. 0 75-2476-01	Fig. 2 75-2477-12	Fig. 2 75-2478-12
		
Fig. 1 75-2476-11	Fig. 3 75-2477-13	Fig. 3 75-2478-13
		
Fig. 2 75-2476-12	Fig. 4 75-2477-14	Fig. 4 75-2478-14
		
Fig. 3 75-2476-13	Fig. 5 75-2477-15	Fig. 5 75-2478-15
		
Fig. 4 75-2476-14	Fig. 6 75-2477-16	Fig. 6 75-2478-16
		
<b>SCHEDÉ</b> 17,0 cm, 6 <sup>3</sup> / <sub>4</sub> "	<b>VOLKMANN</b> 17,0 cm, 6 <sup>3</sup> / <sub>4</sub> "	<b>BRUNS</b> 17,0 cm, 6 <sup>3</sup> / <sub>4</sub> "



Scharfe Löffel  
Bone Curettes  
Cucharillas cortantes  
Curetta per ossa

Fig. 00000  
75-2479-04



**LEMPERT**  
21,5 cm, 8½"

Fig. 0000  
75-2479-03

Fig. 000  
75-2479-02

Fig. 00  
75-2479-01

Fig. 0  
75-2479-00



**HALLE**  
21,0 cm, 8¼"

Fig. 00  
75-2480-02

Fig. 0  
75-2480-01

Fig. 1  
75-2480-11



**DAUBENSPECK**  
20,0 cm, 8"

Fig. 00  
75-2481-02

Fig. 0  
75-2481-01

Fig. 1  
75-2481-11

Fig. 2  
75-2481-12

**Scharfe Löffel**  
**Bone Curettes**  
**Cucharillas cortantes**  
**Curetta per ossa**



**WILLIGER**  
17,0 cm, 6<sup>3</sup>/<sub>4</sub>"



Fig. 1  
**75-2482-11**



Fig. 2  
**75-2482-12**



**WILLIGER**  
14,0 cm, 5<sup>1</sup>/<sub>2</sub>"



Fig. 0  
**75-2483-00**



Fig. 1  
**75-2483-01**



Fig. 2  
**75-2483-02**



**MARTINI**  
14,0 cm, 5<sup>1</sup>/<sub>2</sub>"  
**75-2485-00**



Fig. 00/0  
**75-2485-00**  
14,0 cm, 5<sup>1</sup>/<sub>2</sub>"



Fig. 0/1  
**75-2485-01**  
14,0 cm, 5<sup>1</sup>/<sub>2</sub>"



Fig. 1/2  
**75-2485-12**  
14,0 cm, 5<sup>1</sup>/<sub>2</sub>"



**VOLKMANN**



**75-2486-13**  
13,0 cm, 5"



**75-2486-14**  
14,0 cm, 5<sup>1</sup>/<sub>2</sub>"



**75-2486-17**  
17,0 cm, 6<sup>3</sup>/<sub>4</sub>"



**JANSEN**  
15,0 cm, 6"  
**75-2487-15**



**JANSEN**  
16,0 cm, 6<sup>1</sup>/<sub>4</sub>"  
**75-2487-16**

Dissektoren, Elevatorien  
Dissectors, Elecators  
Disecadores, Elevadores  
Dissettori, Elevatori

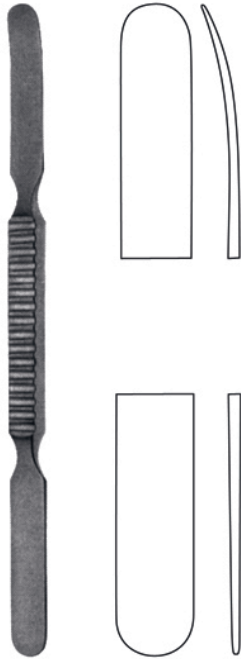

**WATSON-CHEYNE**  
17,5 cm, 6<sup>5</sup>/<sub>8</sub>"  
75-2488-17



**MC DONALD**  
19,0 cm, 7<sup>1</sup>/<sub>2</sub>"  
75-2488-19



**WILLIGER**  
17,0 cm, 6<sup>3</sup>/<sub>4</sub>"  
75-2492-17



**WILLIGER**  
16,0 cm, 6<sup>1</sup>/<sub>4</sub>"  
75-2489-16



**LANGENBECK**  
20,0 cm, 8"  
75-2490-08



**LANGENBECK**  
20,0 cm, 8"  
75-2491-10

Raspatorien  
Raspatories  
Periostótomos  
Periostotomi



**ADSON**  
17,0 cm, 6<sup>3</sup>/<sub>4</sub>"

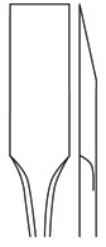

8 mm  
75-2493-01



7 mm  
75-2493-02



7 mm  
75-2493-03



7 mm  
75-2493-04



**KÖNIG**  
15,5 cm, 6"  
75-2494-15



5 mm



**LAMBOTTE**  
21,0 cm, 8<sup>1</sup>/<sub>4</sub>"



10 mm  
75-2494-10



15 mm  
75-2494-15



20 mm  
75-2494-20

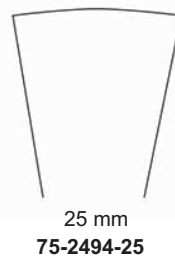

25 mm  
75-2494-25



**FARABEUF**  
15,0 cm, 6"  
75-2495-15



12,5 mm

**Raspatorien  
Raspatories  
Periostótomos  
Periostotomi**



**FARABEU**  
15,0 cm, 6"  
75-2496-15



**LANGENBECK**  
19,0 cm, 7½"  
75-2497-19



**SEDILLOT**  
21,0 cm, 8¼"  
75-2498-21



**WILLIGER**  
16,0 cm, 6¼"

- 4 mm **75-2499-04**
- 6 mm **75-2499-06**
- 8 mm **75-2499-08**



für Kinder  
for children  
para niños  
per bambini

**DOYEN**  
17,0 cm, 6¾"  
75-2500-17



für Kinder  
for children  
para niños  
per bambini

**DOYEN**  
17,0 cm, 6¾"  
75-2501-17



für Erwachsene  
for adults  
para adultos  
per adulti

**DOYEN**  
17,0 cm, 6¾"  
75-2502-17



für Erwachsene  
for adults  
para adultos  
per adulti

**DOYEN**  
17,0 cm, 6¾"  
75-2503-17

Flachmeißel, Hohlmeißel, Osteotome  
Chisels, Gouges, Osteotomes  
Cinceles, Gubias, Osteótomos  
Scalpelli, Sgorbie, Osteotomi

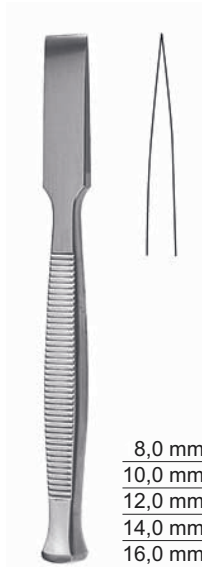

8,0 mm	<b>75-2504-08</b>
10,0 mm	<b>75-2504-10</b>
12,0 mm	<b>75-2504-12</b>
14,0 mm	<b>75-2504-14</b>
16,0 mm	<b>75-2504-16</b>

13,5 cm, 5<sup>3</sup>/<sub>8</sub>"



8,0 mm	<b>75-2505-08</b>
10,0 mm	<b>75-2505-10</b>
12,0 mm	<b>75-2505-12</b>
14,0 mm	<b>75-2505-14</b>
16,0 mm	<b>75-2505-16</b>

13,5 cm, 5<sup>3</sup>/<sub>8</sub>"



8,0 mm	<b>75-2506-08</b>
10,0 mm	<b>75-2506-10</b>
12,0 mm	<b>75-2506-12</b>
14,0 mm	<b>75-2506-14</b>
16,0 mm	<b>75-2506-16</b>

13,5 cm, 5<sup>3</sup>/<sub>8</sub>"



3,0 mm	<b>75-2507-03</b>
4,0 mm	<b>75-2507-04</b>
5,0 mm	<b>75-2507-05</b>
6,0 mm	<b>75-2507-06</b>

**PARTSCH**  
13,5 cm, 5<sup>3</sup>/<sub>8</sub>"



3,0 mm	<b>75-2508-03</b>
4,0 mm	<b>75-2508-04</b>
5,0 mm	<b>75-2508-05</b>
6,0 mm	<b>75-2508-06</b>

**PARTSCH**  
13,5 cm, 5<sup>3</sup>/<sub>8</sub>"



10,0 mm	<b>75-2509-10</b>
15,0 mm	<b>75-2509-15</b>
20,0 mm	<b>75-2509-20</b>
25,0 mm	<b>75-2509-25</b>

**STILLE**  
20,0 cm, 8"

Flachmeißel, Hohlmeißel, Osteotome  
Chisels, Gouges, Osteotomes  
Cinceles, Gubias, Osteótomos  
Scalpelli, Sgorbie, Osteotomi



10,0 mm	<b>75-2510-10</b>
15,0 mm	<b>75-2510-15</b>
20,0 mm	<b>75-2510-20</b>
25,0 mm	<b>75-2510-25</b>

**STILLE**  
20,0 cm, 8"



10,0 mm	<b>75-2511-10</b>
15,0 mm	<b>75-2511-15</b>
20,0 mm	<b>75-2511-20</b>
25,0 mm	<b>75-2511-25</b>

**STILLE**  
20,0 cm, 8"



4,0 mm	<b>75-2512-04</b>
6,0 mm	<b>75-2512-06</b>
8,0 mm	<b>75-2512-08</b>
10,0 mm	<b>75-2512-10</b>
12,0 mm	<b>75-2512-12</b>
14,0 mm	<b>75-2512-14</b>

**ALEXANDER**  
18,0 cm, 7"



4,0 mm	<b>75-2513-04</b>
6,0 mm	<b>75-2513-06</b>
8,0 mm	<b>75-2513-08</b>
10,0 mm	<b>75-2513-10</b>
12,0 mm	<b>75-2513-12</b>
14,0 mm	<b>75-2513-14</b>

**ALEXANDER**  
18,0 cm, 7"



6,0 mm	<b>75-2514-06</b>
9,0 mm	<b>75-2514-09</b>
13,0 mm	<b>75-2514-13</b>
16,0 mm	<b>75-2514-16</b>
19,0 mm	<b>75-2514-19</b>
25,0 mm	<b>75-2514-25</b>
32,0 mm	<b>75-2514-32</b>

**SMITH-PETERSEN**  
20,0 cm, 8"



6,0 mm	<b>75-2515-06</b>
9,0 mm	<b>75-2515-09</b>
13,0 mm	<b>75-2515-13</b>
16,0 mm	<b>75-2515-16</b>
19,0 mm	<b>75-2515-19</b>
25,0 mm	<b>75-2515-25</b>
32,0 mm	<b>75-2515-32</b>

**SMITH-PETERSEN**  
20,0 cm, 8"

Flachmeißel, Hohlmeißel, Osteotome, Hämmer  
Chisels, Gouges, Osteotomes, Mallets  
Cinceles, Gubias, Osteótomos, Martillos  
Scalpelli, Sgorbie, Osteotomi, Martelli



9,0 mm	75-2516-09
14,0 mm	75-2516-14
16,0 mm	75-2516-16
19,0 mm	75-2516-19
25,0 mm	75-2516-25

**SMITH-PETERSEN**  
20,0 cm, 8"



9,0 mm	75-2517-09
14,0 mm	75-2517-14
16,0 mm	75-2517-16
19,0 mm	75-2518-19
25,0 mm	75-2518-25

**SMITH-PETERSEN**  
20,0 cm, 8"



6,0 mm	75-2518-06
15,0 mm	75-2518-15
20,0 mm	75-2518-20
25,0 mm	75-2518-25
30,0 mm	75-2518-30
38,0 mm	75-2518-38
44,0 mm	75-2518-44
50,0 mm	75-2518-50

**LAMBOTTE**  
24,0 cm, 9 1/2"



6,0 mm	75-2519-06
15,0 mm	75-2519-15
20,0 mm	75-2519-20
25,0 mm	75-2519-25
30,0 mm	75-2519-30
38,0 mm	75-2519-38
44,0 mm	75-2519-44
50,0 mm	75-2519-50

**LAMBOTTE**  
24,0 cm, 9 1/2"



**COLLIN**  
20,0 cm, 8"  
75-2520-20



**PARTSCH**  
18,0 cm, 7"  
75-2521-18



**BERGMANN**  
24,0 cm, 9 1/2"  
75-2522-24





**Sterilisation**  
**Sterilization**  
**Esterilización**  
**sterilizzazione**

**Sterilisierzangen**  
**Sterilizing Forceps**  
**Pinzas para esterilización**  
**Pinze per sterilizzazione**



20,0 cm, 8"  
75-2522-20



**CHEATTLE**  
27,0 cm, 10<sup>5</sup>/<sub>8</sub>"  
75-2523-27



**ROGGE**  
23,0 cm, 9"  
75-2524-23



**PYE-SMITH (HARRISON)**  
30,0 cm, 12"  
75-2525-30



**MAYO**  
14,0 cm, 5<sup>1</sup>/<sub>2</sub>"  
75-2526-14



**BUNT**  
12,0 cm, 4<sup>3</sup>/<sub>4</sub>"  
75-2527-12

Schalen  
Trays  
Bandejas  
Bacinelle



**STANDZYLINDER**

Ø 75 x 130 mm	<b>HW-2528-06</b>
Ø 75 x 175 mm	<b>HW-2528-07</b>
Ø 100 x 175 mm	<b>HW-2528-08</b>
Ø 100 x 200 mm	<b>HW-2528-09</b>



**RUNDE SCHALE**

Ø 40,0 mm	<b>HW-1130-04</b>
Ø 60,0 mm	<b>HW-1130-06</b>
Ø 80,0 mm	<b>HW-1130-08</b>
Ø 100,0 mm	<b>HW-1130-10</b>
Ø 120,0 mm	<b>HW-1130-12</b>
Ø 150,0 mm	<b>HW-1130-15</b>



**SPÜLSCHALE**

165 x 55 mm	0,75	<b>HW-1133-00</b>
175 x 70 mm	1,00	<b>HW-1133-10</b>
225 x 100 mm	2,00	<b>HW-1133-20</b>
240 x 95 mm	2,75	<b>HW-1133-30</b>
260 x 120 mm	4,00	<b>HW-1133-40</b>
290 x 100 mm	5,00	<b>HW-1133-50</b>
315 x 150 mm	5,50	<b>HW-1133-60</b>
325 x 135 mm	8,00	<b>HW-1133-70</b>
360 x 165 mm	12,00	<b>HW-1133-80</b>
415 x 150 mm	14,00	<b>HW-1133-90</b>



**NIERENSCHALE**

170 mm	<b>HW-1140-17</b>
250 mm	<b>HW-1140-25</b>
275 mm	<b>HW-1140-27</b>

**Schalen**  
**Trays**  
**Bandejas**  
**Bacinelle**



**INSTRUMENTENKÄSTCHEN**

200 x 150 x 25 mm	<b>75-1200-01</b>
260 x 180 x 30 mm	<b>75-1200-02</b>
300 x 220 x 30 mm	<b>75-1200-03</b>
350 x 220 x 40 mm	<b>75-1200-04</b>
220 x 170 x 50 mm	<b>75-1200-05</b>
280 x 200 x 50 mm	<b>75-1200-06</b>
320 x 240 x 50 mm	<b>75-1200-07</b>
370 x 270 x 50 mm	<b>75-1200-08</b>
420 x 320 x 50 mm	<b>75-1200-09</b>



**NAEDELDOSE**

**75-1300-00**

Ø 65 x 17 mm

Außen- und Innendose

Exterior and interior box

Caja exterior e interior

Scatola esterna es interiore

**75-1300-01**

Ø 62 x 13 mm

Innendose allein

Interior box only

Caja interior, suelta

Scatola interiore sola



**SPÜLSCHALE  
MIT SKALIERUNG**

25 ccm  
**75-310-25**



**SPÜLBECHER  
MIT SKALIERUNG**

50 ccm  
**75-310-50**



# 75 INDUSTRIES

CHOOSE US , TRUST US

## SURGICAL INSTRUMENTS CATALOGUE

+92 (332) 044 4457

[www.azniind.com](http://www.azniind.com)

[info@azniind.com](mailto:info@azniind.com)

Commissioner Rd, Street # 4, Muhammad Pura, Sialkot Pakistan

